



VORTEX®



Britpart Katalog

„Ersatzteile & Zubehör“

www.teile.at

11th Edition



Welcome to the 12th Edition of the Britpart Accessory Catalogue.

This new edition is packed with over **680 new parts**. Many of the new parts are for the latest Land Rover models but with plenty of exciting new accessories for the older range of vehicles too, you'll be able to personalise your Land Rover to your exact needs and wants.

Britpart also stock a vast range of repair parts, many of which are featured in this catalogue, to help Land Rover owners across the world to keep their vehicles going both on and off-road.



At Britpart we are always adding new and exciting products to our accessories range, so remember to look at www.britpart.com for all the latest additions. Also worth remembering is that if there is no picture in the catalogue of a product, then visit our website as there are plenty more product pictures on-line. You can also check out all the news on our Facebook page, so why not visit and 'like us' at www.facebook.com/britpart

01	Exterior Protection	7 - 20
02	Side & Rear Steps	21 - 26
03	Racks & Roll Cages	27 - 36
04	Wheels	37 - 44
05	Lighting Equipment	45 - 52
06	Towing Equipment	53 - 60
07	Interior Protection	61 - 70
08	Seats & Trim	71 - 80
09	Off-Road Equipment	81 - 90
10	Winching Equipment	91 - 102
11	Performance Equipment	103 - 118
12	Suspension & Axle Equipment	119 - 136
13	Vehicle Diagnostics	137 - 146
14	Repair & Service	
	<i>Repair & Service Parts</i>	147 - 160
	<i>Chassis & Body Components</i>	161 - 168
	<i>Service Kits</i>	169 - 172
	<i>Consumables</i>	173 - 180
	<i>Tools</i>	181 - 184
15	Vehicle Enhancements	185 - 200
16	Miscellaneous	201 - 212



For over 35 years Britpart has been supplying quality parts and accessories for Land Rover users across the world and now we are very proud to announce that all* Britpart parts and accessories will be backed by an industry leading **24 month guarantee.**

With a recent multi-million pound investment in the best Land Rover products and with extensive investment in new staff, equipment and procedures we are convinced this new guarantee will give consumers more confidence in Britpart products. This is backed up with our approval by Lloyd's Register Quality Assurance to BS EN ISO 9001:2008.

This pioneering guarantee will cover over 12,000 parts from our extensive parts catalogue, from springs to clutches and from winches to shock absorbers, confidence in the products we supply is assured. If any part is found to be defective following an inspection by our quality team due to faulty materials or workmanship then that part will be replaced free of charge.

With this significant development in Britpart's philosophy we are now confident that the parts the end users fit to their Land Rovers will deliver time after time, whether the customer is buying a part for a Series 3 or a new Range Rover, they are backed by the same 24 month guarantee.

Look out for the Britpart Guarantee Logo which will be gracing all our products in the forthcoming months as a constant reminder to the customer they are fitting the best available parts and accessories to their Land Rover.

Our commitment to you!...



*Subject to our standard terms and conditions. Proof of purchase required by the original point of purchase. Excludes Genuine Land Rovers parts, reconditioned gearboxes & engines. This guarantee does not affect your statutory rights.

The Marque

Britpart is the leading independent wholesaler of parts and accessories for Land Rover vehicles, supplying in excess of 800 customers worldwide from government agencies to trade outlets.

The name 'Britpart' is synonymous with quality parts for Land Rovers and the company has earned a truly enviable reputation around the globe. For over 30 years, Land Rover enthusiasts the world over have come to identify Britpart as a brand to be trusted.

BRITPART

The quality parts for Land Rovers

The Britpart logo has become a widely recognised and highly respected marque; it embodies excellence in the field, both in quality and commitment to meeting the needs of the customer.

Products

Britpart has always reacted swiftly to the demands of the parts market for all Land Rover vehicles, aiming to provide customers with exactly what they want, when they want it. Parts have long been the mainstay of Britpart's business, with many parts simply being unavailable from other sources; however, accessories are now becoming a major part of the business as owners of Land Rovers, old and new, are customising their vehicles to suit their individual tastes and lifestyles; everything they need is now available from Britpart.

The vast array of Britpart accessories ensures that no two Land Rovers are ever identical!

Land Rover appointed Britpart as an 'Approved European Parts Distributor' for all Land Rover Genuine Parts; this, together with Britpart's own vast range of parts and accessories, along with their extensive inventory of O.E.M. product, has resulted in Britpart becoming the ultimate 'One-Stop-Shop' providing everything its customers could possibly require, all ordered and delivered from one dedicated source.

Quality

Britpart is approved by Lloyd's Register Quality Assurance to BS EN ISO 9001:2008.

Britpart is renowned for quality parts at very competitive prices and takes pride in its excellent customer service, maintaining high stock levels with the aim of fulfilling orders promptly.



Distribution

Parts and accessories for Land Rover vehicles continually flow in and out of the massive state-of-the-art warehouse. Britpart's fleet of vans and trucks all sport the undeniably eye-catching Britpart blue and white livery. Between them they cover the length and breadth of the United Kingdom, including Northern Ireland, delivering directly to Britpart customers on a regular basis, adding to the personal touch that customers have come to associate with Britpart.

Global

When Land Rover finally severed its association with Santana Motor SA it was Britpart who bought up all the existing stock from the factory in Spain and shipped it to their UK headquarters in Shropshire. The shipment included everything from small components to body panels and new engines, along with all the original drawings and tooling. Some of the stock was found to be interchangeable with Land Rover parts and a proportion of the rest is gradually making the journey back home with the assistance of our partner in Spain, Britpart España, Estanfi Automoción.

Britpart's other partners around the globe include: Britpart France, Britpart Belgium, Britpart Brazil, Britpart USA and Britpart Poland.

Britpart is seeking to further expand its comprehensive customer base overseas and is continually looking for well established independent stockists of Land Rover parts to work closely with.

Service

Britpart has an enthusiastic and highly knowledgeable team so that you deal with people who have in-depth knowledge of the business. In addition to major government contracts, we successfully support individual parts retailers, supplying spares for Land Rover models old and new including Series, Defender, Range Rover, Discovery and Freelander.

The lively Sales operation boasts three highly trained teams; one each for Home Sales, European Sales and

Export Sales with technical experts and sales advisors in each, eager to answer the telephone and organise despatch of goods to their customers within the shortest possible time.

Handmade

The highly skilled team in the Trim Shop make a wide range of seats, seat covers, bases, backs and benches etc for Land Rover vehicles by hand.

Equally skilled is the team in the Lock Shop where a wide range of light engineering work is carried out.

In keeping with the Britpart philosophy, all products leaving the Trim Shop and the Lock Shop are produced to the highest standards and meet with the strictest safety regulations.



Quality Parts

Britpart hold in excess of 17,000 stock items from o-rings and oil seals to engines and exhaust systems. Customers can choose from Britpart quality parts, O.E.M. products and Land Rover Genuine Parts; all delivered promptly at competitive prices.

Everything required for servicing, repairing, restoring or even rebuilding any Land Rover can be supplied by Britpart, thus enabling customers to order all they need on just one order sheet making it easy to keep track of stock and take delivery.

Quality Accessories

Britpart have all the latest accessories you need to customise your Land Rover, whatever the model, to look great on the road and work better off it! From wheels to roof racks, Britpart have everything to ensure that no two Land Rovers need ever look identical.

Exterior Protection

Whether you are going off-road or just want some extra protection on the road for your Land Rover, our wide range of exterior protection is a must have to prevent damage from hidden dangers. We have many forms of exterior protection including chequer plate, A-bars, bumpers, light guards, dash cameras and much more! This section is where you will find protection from front to back and top to bottom for your Land Rover.

- Chequer Plate** 8
- Dirt D-fenders** 14
- Front Protection** 9
 - A Bars 9
 - Bumpers & bumperettes 10
 - Dash camera 9
- Light Guards** 11
 - Defender 11
 - Discovery 12
 - Freelander 13
 - Range Rover 13
 - Series 11
- Locking Fuel Cap** 10
- Mirrors** 14
 - Blind spot mirror 14
 - Standard mirrors 14
 - Unbreakable mirrors 14
- Mudflaps** 15
- Rear Protection** 16
 - Bumpers & bumperettes 16
 - Parking sensors 16
 - Replacement rear surround cameras 16
 - Reversing camera kits 16
- Security Marking Kit** 20
- Side Protection** 17
 - Rock & tree sliders 17
 - Rubbing strips 18
 - Wheel arch kits 18
- Tamper Proof Nuts & Bolts** 10
- Underside Protection** 19
 - Diff guard 19
 - Fuel cooler guard 19
 - Fuel tank, steering/sump & transmission guards 19
 - Swivel housing gaiter kits 20
 - Universal joint silicone sleeves 19
- Wind Deflectors** 20



Chequer Plate

Add some **heavy-duty** protection to your Land Rover.



Defender - Natural aluminium finish		
DA2054	Bumper top plate	Single
DA2062	Bumper top plates	Pair
DA2060	Mudflap brackets	Pair
DA2061	Rear cross member	Single
DA2063	Rear floor - 110 CSW	Single
DA2064	Rear sides - 110 CSW	Pair
DA2067	Rear door - without wiper	Single
DA2068	Rear door - wiper - late	Single
DA2069	Rear door - wiper - early	Single
DA2070	Load bay liner	Kit
	90/Pickup/Hard top/County Station Wagon	
DA4072	Sills - 90	Pair
DA4073	Rear wing - 90	Pair
DA4100	Sills - 110	Pair
DA4071	Rear wing - 110	Pair
DA4049	Wing tops	Pair
DA4049S	Wing tops - Note - painted silver finish	Pair
	Load bay liner	Kit
	90/Pickup/Hard top/County Station Wagon	
DA4072	Sills - 90	Pair
DA4073	Rear wing - 90	Pair
DA4100B	Sills - 110	Pair
DA4071B	Rear wing - 110	Pair
DA4049B	Wing tops	Pair
	Bonnet protector	
DA3081	Defender - 1983 - 2006	Single
	Curved plate - pre-drilled holes	
	Bonnet protector	
DA4342	Defender - 2007 onwards	Kit

Defender - Satin black finish		
DA4072B	Sills - 90	Pair
DA4073B	Rear wing - 90	Pair
DA4100B	Sills - 110	Pair
DA4071B	Rear wing - 110	Pair
DA4049B	Wing tops	Pair
	Bonnet protector	
DA3081	Defender - 1983 - 2006	Single
	Curved plate - pre-drilled holes	
	Bonnet protector	
DA4343	Defender - 2007 onwards	Kit

Defender - Chequer Plate Kits - Natural aluminium finish		
Kit contains - bonnet, wings, sills & rear corner protection		
DA4296	Defender 90	Kit
DA4297	Defender 110	Kit



More chequer plate images at www.britpart.com/plate

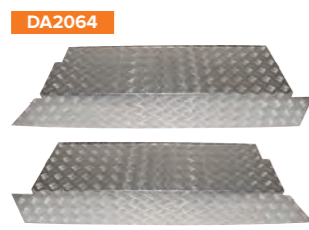

Series - Natural aluminium finish		
DA2004	Wing top	Pair
DA2050	Rear cross member	Single
DA2051	Load bay liner - short wheel base	Kit
DA2052	Sills - short wheel base	Pair
DA2053	Sills - long wheel base	Pair
DA2054	Bumper plate	Single
DA2067	Rear door - without wiper	Single
DA4074	Rear wing - short wheel base	Pair

Miscellaneous - Natural aluminium finish		
DA2065	Chequer plate steel sheet 1,200 x 2,500mm	Single



Front Protection



Defender		
VPLPP0060	Black rubber	Includes spot lamp brackets
	Defender - no winch	
VPLPP0061	Black rubber	Includes spot lamp brackets
	Defender - with winch (genuine winch bumper only)	
Discovery		
LR005237LR	Moulded black rubber	Includes spot lamp brackets
	Discovery 3	
VPLAP0022	Moulded black rubber	Includes spot lamp brackets
	Discovery 4 - up to DA999999	
Freelander		
STC50413	Preformed plastic & foam	No spot lamp brackets
	Freelander 1	
LR003319	Freelander 2 - with or without parking sensors	Black bumper styling cover
	Black bumper styling cover	No spot lamp brackets
Range Rover		
VUB501980	Moulded grey plastic	No spot lamp brackets
	Range Rover Sport - 2005 - 2009	
LR005239	Moulded black plastic	Includes spot lamp brackets
	Range Rover L322	



IMPORTANT NOTICE Please check local legislation before fitting a frontal protection device to a vehicle that is to be used on public roads.



Dash Camera **NEW**

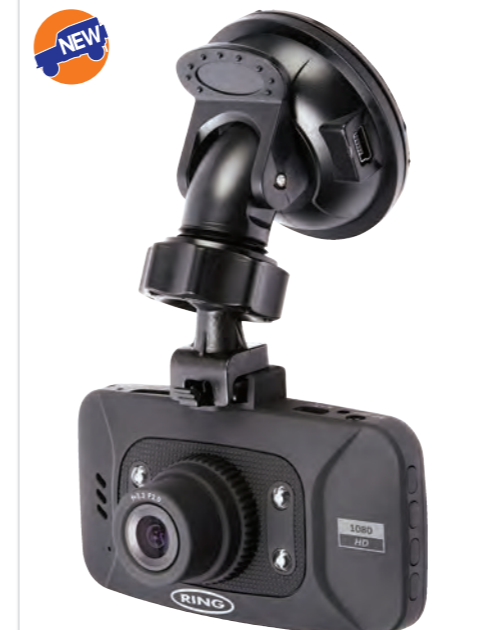

DA5061 NEW
 Plug & play camera features 1,080 pixel resolution meaning important details such as vehicle number plates are more visible. An integrated shock sensor works together with a file locking function, to ensure vital recordings are always protected against overwriting. The camera automatically starts recording, when the vehicle ignition is switched on. Older files can be automatically overwritten, so recording never stops. A built-in battery provides backup power, so recordings can always be completed if the power fails. Camera mode allows the unit to operate as a digital camera, so should an incident occur, additional pictures can be taken. Full camera specifications can be found online at www.britpart.com/dash



Bumpers & Bumperettes



Defender
DPB000270 Military front bumper
RRC6681 Centre pin for bumper
RRC6682 'R' Clip for centre pin
DA5626 Bumper kit - contains all the above part numbers
DPB000270GALV Galvanised military front bumper
DPB104270S NEW Front bumper with silver finish
Defender/Series
RTC4769 Galvanised front bumperette - single



Defender Bumper Fitting Kits
DA1171K NEW Easier to fit plates
 These replace the standard fitted spring clip plates. With stainless steel bolt set.
DA1171 NEW Easier to fit plates
ALQ710020K NEW Tapping blocks & stainless steel bumper bolt kit
DA1269 NEW Tapping blocks & bumper bolt kit
DA1268 NEW Bumper bolt kit

Locking Fuel Cap

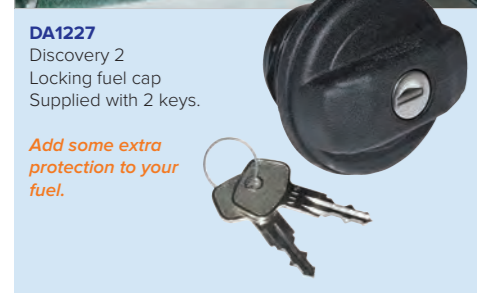

DA1227 Discovery 2
 Locking fuel cap
 Supplied with 2 keys.
 Add some extra protection to your fuel.

Tamper Proof Nuts & Bolts



Ensure your precious accessories remain firmly on your Land Rover by using a set of these tamper proof nuts and bolts. Ideal for securing your winch and front bumper. Each set contains either 4 nuts or bolts and 1 key.
DA7330 NEW M6 nut set & key
DA7331 NEW M8 nut set & key
DA7332 NEW M10 nut set & key
DA7333 NEW M10 x 110 bolt set & key
DA7334 NEW M10 x 35 bolt set & key

NEW Sign up to the regular Britpart newsletter to find out about all the latest product releases.
www.britpart.com/newsletter

Light Guards

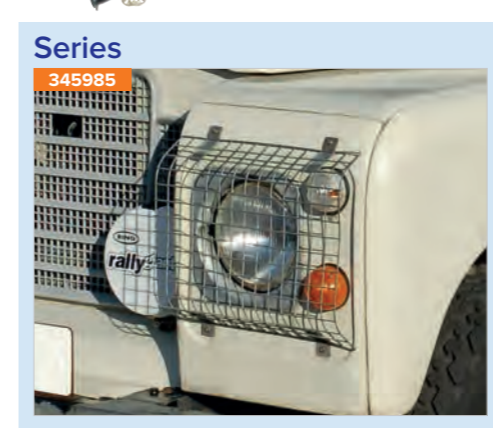
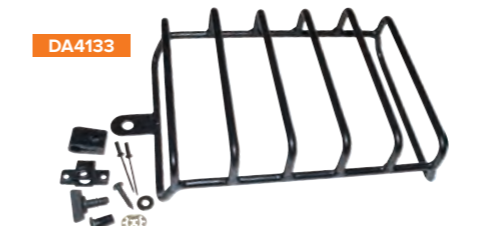

Defender

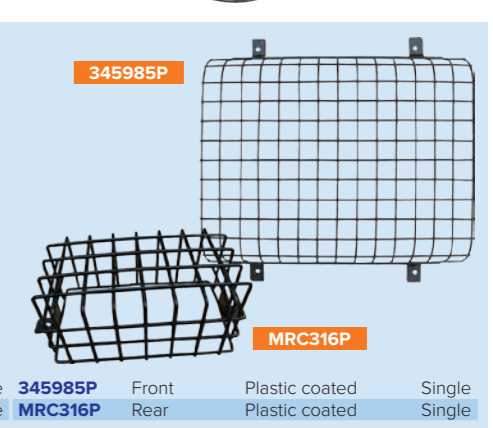
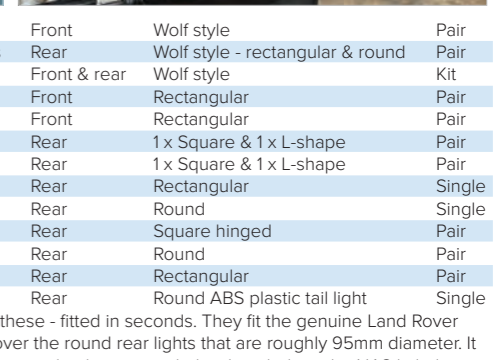
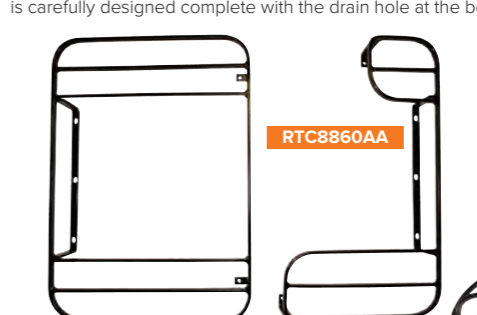
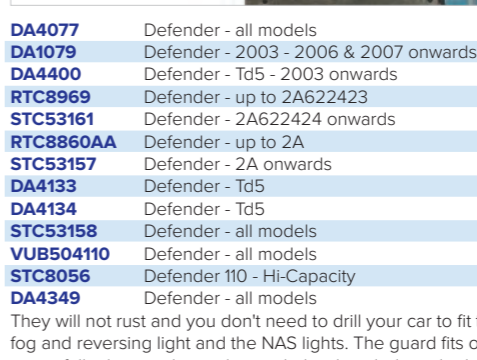

DA4077	Defender - all models	Front	Wolf style	Pair
DA1079	Defender - 2003 - 2006 & 2007 onwards	Rear	Wolf style - rectangular & round	Pair
DA4400	Defender - Td5 - 2003 onwards	Front & rear	Wolf style	Kit
RTC8969	Defender - up to 2A622423	Front	Rectangular	Pair
STC53161	Defender - 2A622424 onwards	Front	Rectangular	Pair
RTC8860AA	Defender - up to 2A	Rear	1 x Square & 1 x L-shape	Pair
STC53157	Defender - 2A onwards	Rear	1 x Square & 1 x L-shape	Pair
DA4133	Defender - Td5	Rear	Rectangular	Single
DA4134	Defender - Td5	Rear	Round	Single
STC53158	Defender - all models	Rear	Square hinged	Pair
VUB504110	Defender - all models	Rear	Round	Pair
STC8056	Defender 110 - Hi-Capacity	Rear	Rectangular	Pair
DA4349	Defender - all models	Rear	Round ABS plastic tail light	Single

They will not rust and you don't need to drill your car to fit these - fitted in seconds. They fit the genuine Land Rover fog and reversing light and the NAS lights. The guard fits over the round rear lights that are roughly 95mm diameter. It is carefully designed complete with the drain hole at the bottom that lines up with the drain hole in the NAS light base.

345985	Front	Natural finish	Single	345985P	Front	Plastic coated	Single
MRC316	Rear	Natural finish	Single	MRC316P	Rear	Plastic coated	Single

Discovery



Protect your **valuable headlights** from accidental damage either on or off-road!

DA4172	Discovery 1 - 300Tdi	Front - acrylic headlight protectors	
STC8453G	Discovery 1	Rear bumper - no drill fit	
RTC9503AA	Discovery 1	Rear wing	
STC50026	Discovery 2 - up to 3A	Front	
STC50064	Discovery 2 - up to 3A	Front - acrylic headlight protectors	
STC53181	Discovery 2 - 3A onwards	Front	
		For fitment with nudge bar (STC53176)	
STC53193	Discovery 2 - 3A onwards	Front	
STC50027	Discovery 2 - all models	Rear bumper & rear upper set	
STC53194	Discovery 2 - all models	Rear wing	
VUB500520	Discovery 2 - all models	Rear low	
VUB501200	Discovery 3 - all models	Front	
VUB501380	Discovery 3 - all models	Rear	
VPLAP0008	Discovery 4 - all models	Front	
VPLAP0009	Discovery 4 - all models	Rear	

Note - All Discovery headlight guards supplied as pairs.

Range Rover



STC8027LR	Range Rover Classic	Rear - hinged
STC8503AALR	Range Rover P38	Front - drill fit
STC8504ABLR	Range Rover P38	Rear - drill fit
DA4173	Range Rover P38 - up to 1999	Front
VUB501930	Range Rover Sport - 2005 - 2009	Front
VUB501920	Range Rover Sport - 2005 - 2009	Rear
VPLSP0010	Range Rover Sport - 2010 - 2013	Front
VPLTP0064	Range Rover Sport - 2010 - 2013	Rear
VUB001070LR	Range Rover L322 - up to 6A	Front
VUB001080LR	Range Rover L322	Rear

Note - Front lamp guards not compatible with wraparound protection bar
Note - All Range Rover headlight guards supplied as pairs

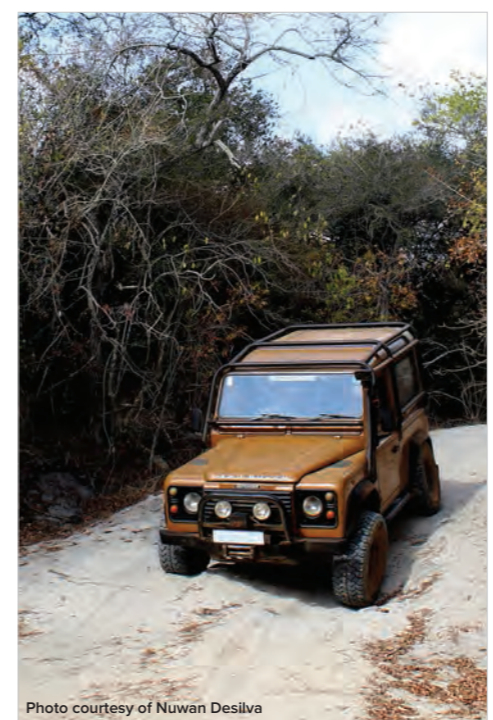

Freelander

VUB501390 NEW	Freelander 1 - 2004 onwards	Front	Pair
LR002408	Freelander 2	Front	Pair
LR003685	Freelander 2	Rear	Pair
LR002408			



Mirrors



Photo courtesy of Christian Teasdel

Blind Spot Mirror **NEW**

DA6550R **NEW** Right hand side
DA6550L **NEW** Left hand side

Working closely with one of Europe's leading mirror manufacturers, MUD has created a retrofit mirror for the Defender that incorporates a wide angle convex mirror to eliminate potentially dangerous blind spots. The Blind Spot Mirror function offers a huge improvement in road safety, making lane changing manoeuvres safer whether you're in slow or fast moving traffic.



The surface area of the XL Defender Mirror Head measures 245mm x 140mm compared with the standard mirror glass area of 198mm x 124mm. The mirror area of the MUD Blind Spot mirror is 173mm x 127mm and the convex section is 52mm x 127mm. The convex section is fixed and not adjustable.

The MUD Blind Spot mirror is a straight swap for the original Defender door mirrors, using the same fixing method as the factory mirrors and even retain the same styling as the original Defender door mirror to ensure an OE factory appearance. The MUD Blind Spot Mirror is housed within a larger mirror head that in addition to providing a larger reflective surface area than the standard Defender mirror glass, features the convex wide angle mirror glass. The mirror insert can be flipped through 180 degrees within the mirror head so the wide-angle can be positioned at the top or the bottom of the mirror. The MUD Blind Spot Mirror has been fully homologated, E-marked and carries full EU Type Approval.

Standard Mirrors



Series	Part	Dimensions	Notes
DA2128	Mirror arm	7"	Standard
DA2130	Mirror head	7 x 5"	Standard
DA2301	Mirror glass	7 x 5"	Standard

Defender	Part	Dimensions	Notes
MTC5083	Mirror arm	7"	Standard
RRC8443	Mirror arm	11 1/2"	Large
MTC5084	Mirror head	5 x 8"	Standard
DA4034	Mirror head	6 x 10 1/2"	Large
MTC5217	Mirror assembly		Standard



DA4598 **NEW**
Heated mirror kit
See vehicle enhancement section for more details.



Unbreakable Mirrors

	Head Dimensions	Arm Length	Notes
DA4404	Flat mirror 204 x 140mm (8 x 5 1/2")	No arm	Flat with fixing kit
DA4405	Flat mirror 204 x 140mm (8 x 5 1/2")	170mm	Flat with fixing kit and short arm
DA4406	Flat mirror 204 x 140mm (8 x 5 1/2")	290mm	Flat with fixing kit and long arm
DA4407	Convex mirror 204 x 140mm (8 x 5 1/2")	No arm	Convex with fixing kit
DA4408	Convex mirror 204 x 140mm (8 x 5 1/2")	170mm	Convex with fixing kit and short arm
DA4409	Convex mirror 204 x 140mm (8 x 5 1/2")	290mm	Convex with fixing kit and long arm

Good visibility is imperative on today's highways and byways so these new high impact resistant mirror heads are an essential item.

- > Optical quality polycarbonate lens - will not shatter like glass or discolour in sunlight.
- > Strong, flexible polypropylene casing - will absorb hard blows without breaking.
- > Universal - can be fitted to either left or right of vehicle.
- > Lightweight - puts less strain on body fixings.
- > Hard lacquer coating on lens - will repel condensation and surface water.
- > Excellent reflectivity - superb daylight and night time vision.

Dirt D-fenders

Keep the side of your Defender cleaner!



DA1193	Defender - 90/110/130	Rear of front wheel
DA1198	Defender - 90/110	Front of rear wheel
DA1197	Defender - 90	Rear of rear wheel
DA1194	Defender - 110	Rear of rear wheel

Note - DA1193 & DA1198 will not fit Defenders with rock/tree sliders fitted.



DA1194

Mudflaps

Reduce those muddy splashes from over your Land Rover.

Defender - 1987 onwards

Part	Dimensions	Notes
CAS500180PMA	90/110/130 - up to AA792970	RH
LR055323	90/110/130 - from AA792971	RH
CAS500190PMA	90/110/130 - up to AA792970	LH
LR055333	90/110/130 - from AA792971	LH
RTC4685	90/110/130 - flaps only	Pair
RTC9479	90/110/130 - with brackets	Pair

Part	Notes	Notes
CAT500410PMA	90 - up to AA792970 - black Britpart logo	RH
LR055332	90 - from AA792971 - black Britpart logo	RH
CAT500540PMA	90 - up to AA792970 with exhaust cut-out - black Britpart logo	LH
LR055340	90 - from AA792971 with exhaust cut-out - black Britpart logo	LH
CAT500450PMA	90 - no exhaust cut-out - black Britpart logo	LH
DA4531	90 - with exhaust cut-out - yellow Britpart logo	Pair
DA4532	90 - no exhaust cut-out - yellow Britpart logo	Pair

Part	Notes	Notes
DA4533	90 - Wide mudflaps - universal fitment - no exhaust cut-out - yellow Britpart logo	Pair
MXC6412	90 - from FA414687 up to WA159806	RH
MXC6413	90 - from FA414687 up to WA159806	LH
MUC3990	90 - hard & soft top - from AA232011 up to FA414686	LH
MUC2344	90 - from 3A650368 up to 5A690309	RH
DA4534	110/130 Crew cab - yellow Britpart logo	Pair
DA4536	110/130 Crew cab - Wide mudflaps - yellow Britpart logo	Pair
BTR277	110/130 - universal - flap only - from FA414616	Single
CAT500340PMA	110/130 - up to AA792970 - black Britpart logo	RH
LR055330	110/130 - from AA792971 - black Britpart logo	RH
CAT500350PMA	110/130 - up to AA792970 - black Britpart logo	LH
LR055334	110/130 - from AA792971 - black Britpart logo	LH
CAT500360PMA	110/130 HCPU - up to AA792970 - black Britpart logo	RH
LR055331	110/130 HCPU - from AA792971 - black Britpart logo	RH
CAT500370PMA	110/130 HCPU - up to AA792970	LH
LR055339	110/130 HCPU - from AA792971	LH
DA4535	110/130 HCPU - yellow Britpart logo	Pair

Part	Notes	Notes
DA4531	Galvanised front mudflap brackets - pair	Equivalent to MTC3000 & MTC3001 Defender 90/110
DA1188	Galvanised rear mudflap brackets - pair	Equivalent to MUC3986 & MUC3987 Defender 90



Britpart now offer a wider than standard mudflap, ideal for Defenders fitted with wheel spacers.



Note - RH - Right hand side / LH - Left hand side

Discovery

RTC6820	Front	Pair
RTC6821	Rear	Pair

Discovery 2	Notes	Notes
CAS100900	Front & rear	RH
CAS100910	Front & rear	LH

Discovery 3	Notes	Notes
CAS500010PCL	Front	Pair
CAT500010PCL	Rear - unpainted bumper	Pair
VPLAP0017	Rear - partially painted bumper	Pair

Discovery 4	Notes	Notes
CAS500010PCL	Front	Pair
CAT500010PCL	Rear - unpainted bumper	Pair
VPLAP0017	Rear - partially painted bumper	Pair

Discovery Sport	Notes	Notes
VPLCP0203	Front	Pair
VPLCP0204	Rear	Pair

Discovery Sport	Notes	Notes
VPLCP0204	7-seat without spare wheel & 5-seat	Pair
VPLCP0205LR	Rear	Pair
	7-seat with spare wheel	Pair

More mudflap images at www.britpart.com/mudflaps



Rear Protection



DA5647
Discovery 1 - 300Tdi - will also fit 200Tdi see note below
> One piece rear heavy-duty bumper manufactured from 5mm steel with incorporated steel end caps and 2 recovery points, finished in black.
> Provision for NATO/recovery point in centre of bumper.
> Fixed to standard mounting points and for added strength, extra fixings in centre where tow bar mounts.
Note - Tow bar and rear lights not included.
Will fit 200Tdi if 300Tdi lamps are used.
Right lamp - AMR6510; left lamp - AMR6509

Bumpers & Bumperettes



DA5646
Discovery 2
> One piece rear heavy-duty bumper manufactured from 4mm steel with incorporated steel end caps, finished in black.
> 2 Recovery points and 2 Hi-Lift jacking points included.
> Fixed to standard mounting points and for added strength, extra fixings in centre where tow bar mounts.
Note - Tow bar and rear lights not included.
Up to 3A771194 - right lamp - XFB101480; left lamp - XFB101490. From 3A771195 - right lamp - XFB000720; left lamp - XFB000730

Added protection...

DA2071	Defender/Series	Pair	Black
RRC2970	Defender/Series	Single - RHS	Black
RRC2971	Defender/Series	Single - LHS	Black
ISG000040	Defender Wolf	Single - RHS	Black
ISG000050	Defender Wolf	Single - LHS	Black



Replacement Rear Surround Cameras

- LR031790**
Range Rover Sport - 2010 - 2013
- LR031812**
Range Rover L322 - 2010 - 2012
- LR052028 NEW**
Discovery 4 - Front bumper/tailgate/side view mirrors
- Range Rover Evoque - Front bumper/side view mirrors
- Range Rover Sport - 2014 onwards - Front bumper/side view mirrors
- Range Rover L405 - Front bumper/side view mirrors



Reversing Camera Kits NEW

- DA6611 NEW**
Rear facing camera kit - includes monitor
Typically mounted under the number plate on a Defender and on the rear end door handle on a Freelander, Discovery & Range Rover Classic.
- DA6610 NEW**
Front facing camera kit - no monitor
An additional camera to add to DA6611 kit.
- DA6613 NEW**
Rear facing camera kit - no monitor
An additional camera to use on a trailer which can be added to DA6611 kit. Cable length is 20 metres.

Seeing exactly what is behind a Land Rover is not easy using conventional mirrors. This kit is a practical driver assistance device with the primary objective of helping the driver to see things that they may not otherwise see when reversing. The kit is engineered to the highest standards with a focus on making it simple to install, robust and discreet. One connection is made to the reversing light circuit and ground to the bodywork. A single cable is then fed through the vehicle from the back to the front to connect the camera to the 3½" slim line monitor. No other work is involved. When the vehicle is put into reverse gear, a sharp and vivid image is instantly displayed on the screen. The camera is the only external part and much like the vehicle it will be installed on it can be submerged in water, it can be blasted by a jet wash, sprayed with mud. Effectively there is very little that can be done to damage the camera, short of hitting it with a solid object. But even then it can withstand some abuse.

- > Waterproof rear view or reverse camera.
- > Small, discreet, MicroBlock™ colour camera.
- > Slimline 3½" LCD monitor.
- > Typically installed above number plate to include the rear bumper in the field of view.
- > Outstanding image quality both day & night.
- > Panoramic view.
- > Instant image on.
- > Single cable installation technology - easy to install.
- > IP68 rated so 100% water and dust proof.



Outstanding image quality

Parking Sensors



Reduce the risk of collision during reversing.

DA4511
These bumper* mounted sensors will detect the distance between your vehicle and any rear obstruction and warn the driver to any potential obstructions. An advanced parking solution for obstacle detection at the rear of your vehicle. Reduce the risk of collision during reversing and reverse parking manoeuvres with this kit.

As the reverse gear is engaged, a sound indicates that the reverse sensors are activated. Any obstacle at the rear of the vehicle is then detected and signalled to the driver through a progressive sound whose frequency increases when moving closer to the obstacle.

Enhance your safety through obstacle detection, even when objects are out of the driver's field of vision. Improve comfort through easy parking manoeuvres. Suitable for 12v cars, SUVs and light commercial vehicles.

- Kit contents include -
- 4 x Bumper fit sensors
 - 1 x Warning buzzer
 - 1 x Control unit
 - 1 x Wiring harness
 - 1 x Cutting tool
 - 1 x Fitting accessories
 - 1 x Installation instructions

Add an extra set of 'eyes' when reversing...



*Note - Not suitable for vehicles with metal bumpers.

Side Protection



DA7533
Rock slider/side steps - pair
Discovery 3 & Discovery 4
The best of both worlds with these fitted to your Discovery!
Rock slider - an essential purchase for any off road use. They prevent damage to the underside sill of the vehicle and allow for safe passage over rocky and rough terrain.
Side steps - users often fit side steps to enable easy access to and from the car - this is a problem when going off road as they bend, break and cause snagging. These are heavy-duty side steps made from 5mm steel plate with 50mm tube backed up by an additional 2 x 40mm tube supports. The joints are TIG welded for a smooth OEM finish.



Rock & Tree Sliders



DA7534 Aluminium finish
Discovery 3 & Discovery 4
These rock sliders (sill protectors) are manufactured from 6mm 5083 aluminium and come completely machined and drilled ready to fit. An essential purchase for any off-road use as they prevent damage to the underside sill of the vehicle and allow for safe passage over rocky and rough terrain. Attaches to your vehicle using 11 mounting points on the side and underneath and when the car doors are closed they are almost unseen, but you have the piece of mind that your car sills are safe from damage. These units require no additional drilling just unscrewing and unclipping of the plastic OEM parts. For more information & images of these rock sliders visit www.britpart.com/rock



DA7534B Black finish

For more side protection - see side & rear step section



Great protection for the side of your Land Rover and they replace the sill of your vehicle. These rock & tree sliders are a fully welded 3mm steel construction with heavy-duty chassis mounted brackets and zinc primed with a smart black powder coated finish.

- Rock Sliders**
- DA1307** Defender 90 - 1983 onwards
 - DA1308** Defender 110 - 1984 onwards
 - DA1311** Discovery 1 - 3-door **COMING SOON...**
 - DA1312** Discovery 1 - 5-door **COMING SOON...**
 - DA1313** Discovery 2 **COMING SOON...**

- Rock & Tree Sliders**
- DA1307T** Defender 90 **COMING SOON...**
 - DA1308T** Defender 110 **COMING SOON...**
 - DA1311T** Discovery 1 - 3-door **COMING SOON...**
 - DA1312T** Discovery 1 - 5-door **COMING SOON...**
 - DA1313T** Discovery 2 **COMING SOON...**

Direct fit!
No Cutting!



Photo courtesy of Andy Yung

Rubbing Strips



Protect your bodywork from dents and scrapes with a smart set of 4 solid and durable bodyside moulding strips.

- VPLAP0013** Discovery 3/Discovery 4
- DGJ500020PCL** Range Rover Sport - 2005 - 2013



Sign up to the regular Britpart newsletter to find out about all the latest product releases.
www.britpart.com/newsletter

Wheel Arch Kits

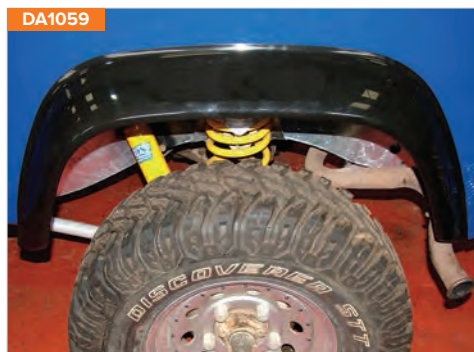

Replace any faded or damaged wheel arches with this OEM replacement wheel arch kit

- DA1059** Defender - all models 4 eyebrows and rivets
- DA1140** Discovery 2 Front/Rear & RHS/LHS



- Off-Road Wheel Arch Kits**
2.5" wheel arch kits. Wings need cutting for fitting.
- DA2364** Discovery 1/Range Rover Classic 3-door
 - DA2365** Discovery 1/Range Rover Classic 5-door

2" wider than standard enabling tyres up to 14" wide and/or wheel spacers to be fitted while being legal for MOT testing. Made from an unbreakable plastic - ideal for extreme off-road use.

- DA2366** Defender 90/110 - 1984 onwards

These two Discovery 2 wheel arches enable larger tyres to be fitted while still being legal as these arches cover the tyres when wider tyres are fitted. The 50mm ones are required for large off set wheels while the 75mm arches will cover the tyres when wheel spacers are used. They are virtually indestructible and all fixings are supplied with the kit. Up to 35" diameter tyres are ok with a 2" lift and these arches as just over 40mm is cut out of the wings when fitting them.

- DA1960** Discovery 2 50mm
- DA1961** Discovery 2 75mm

Underside Protection

Fuel Tank, Steering/Sump & Transmission Guards



Great protection from hidden dangers.

Sump guards
These guards from Britpart are manufactured from high-quality, hard-wearing and corrosion resistant materials to counteract any unforeseen obstacles your Land Rover may encounter whilst off-roading. All fixings are supplied and the guards fit into the vehicle's pre-existing holes. Each guard has holes at the front to allow for water drainage and also to help with ventilation for the cooling system.

- DA5507** Defender - 1985 - 2006 & 2007 onwards RHD
 - DA5507LHD** Defender - 1985 - 2006 & 2007 onwards LHD
 - DA5508** Discovery 1/Range Rover Classic RHD & LHD
 - DA2249** Discovery 2 RHD & LHD
- Powered coated steel Main plate - 5mm thick; brackets - 5mm thick
- Note** - For use with Discovery 2 winch bumper DA5645

Sump plate
DA7536 Discovery 3/Discovery 4
This sump plate protects the underside of the engine and allows the car to slide over objects, forward and backwards due to the rear lip. With a natural finish the plate is made from 6mm 5083 grade aluminium and has been water jet cut to a precise finish. Plate bolts directly into existing holes and bulkheads already in the chassis, using the standard Land Rover fixings.

Transmission Guards
DA5625 Defender - Td5
Reduce damage to your Defender 90. Made from galvanised steel, this transmission guard protects your 90's gear box and cross members from snagging and reduces damage to your vehicle. Bolts on and is easy to fit and importantly it is also easy to remove when your vehicle needs servicing. **Note** - Only fits with centre exhaust removed and pipe fitted.

DA7532 Discovery 3/Discovery 4
This transmission plate protects the underside of the transmission and allows the car to slide over objects. With a natural finish the plate is made from 6mm 5083 grade aluminium and water jet cut to a precise finish. Plate bolts directly into existing holes and bulkheads already in the chassis, using the standard Land Rover fixings and two additional fixings. **Note** - Can only be fitted when sump plate (DA7536) is also fitted.

An essential purchase for any off road use as they prevent damage to the underside of the engine and the intercooler at the front of the vehicle. Manufactured from 8mm 5083 aluminium with a smart silver or black finish and supplied completely machined and drilled ready to bolt directly to the 4 pre-drilled holes in the chassis with supplied galvanised fixings. The guard requires no additional drilling just unscrewing and unclipping of the plastic OEM parts. Fitting should take 5 minutes.

- Discovery 3 **DA7530** Silver finish **DA7530B** Black finish
- Discovery 4 **DA7535** Silver finish **DA7535B** Black finish



Fuel Cooler Guard



DA6540 Defender - Tdci
Protect the Defender's vulnerable fuel cooler with this easy to fit electro-plated guard.

Diff Guard



DA2250B Defender/Discovery 1/Range Rover Classic
Give your vehicle some extra protection with a diff guard. This guard is simple to fit (no drilling) and has the added advantage of having the fill plug accessible at all times. With electroplate finish.

Universal Joint Silicone Sleeves



Suitable for Series, Defender, Discovery 1, Discovery 2 & Range Rover Classic. By adding one of these silicone sleeves you will reduce debris from building up in the universal joint which, in time, will increase the life span of the joint.
DA4810 Rear UJ silicone sleeve for 63mm diameter propshafts
DA4811 Rear UJ silicone sleeve for 51mm diameter propshafts

Swivel Housing Gaiter Kits

Permanent Protection!

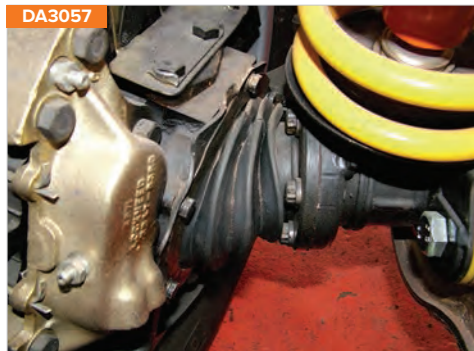

- > Bond in place under existing flange.
- > Completely seals against dust, water and grit.
- > Moulded in high performance neoprene rubber.
- > No special tools required.
- > Proven tongue and groove for easy assembly.
- > Two year guarantee.
- > Kit includes two gaiters, metal straps, bonding agent, gloves and full instructions.

DA3056 Series
DA3057 Defender/Discovery 1/Range Rover Classic
DA3057GLUE

Additional bonding agent for DA3056 & DA3057
 For easier fitment of gaiter without dismantling the axle assembly.

Security Marking Kit



DA8533 NEW
 Help prevent your Land Rover from being stolen with this easy to use security marking kit. Full details of the kit can be found in the miscellaneous section or at www.britpart.com/security

Side & Rear Steps

Whether you need to replace a broken step, or want to smarten up your Land Rover with new steps, our selection will provide assistance when getting in and out of your vehicle. We have both rear and side steps in a variety of styles and patterns to allow you to find the one that best suits your Land Rover!

Defender	
Side protectors.....	22
Side steps.....	22 - 23
Rear steps.....	23
Discovery	24
Freelander	23
Range Rover	25

Wind Deflectors

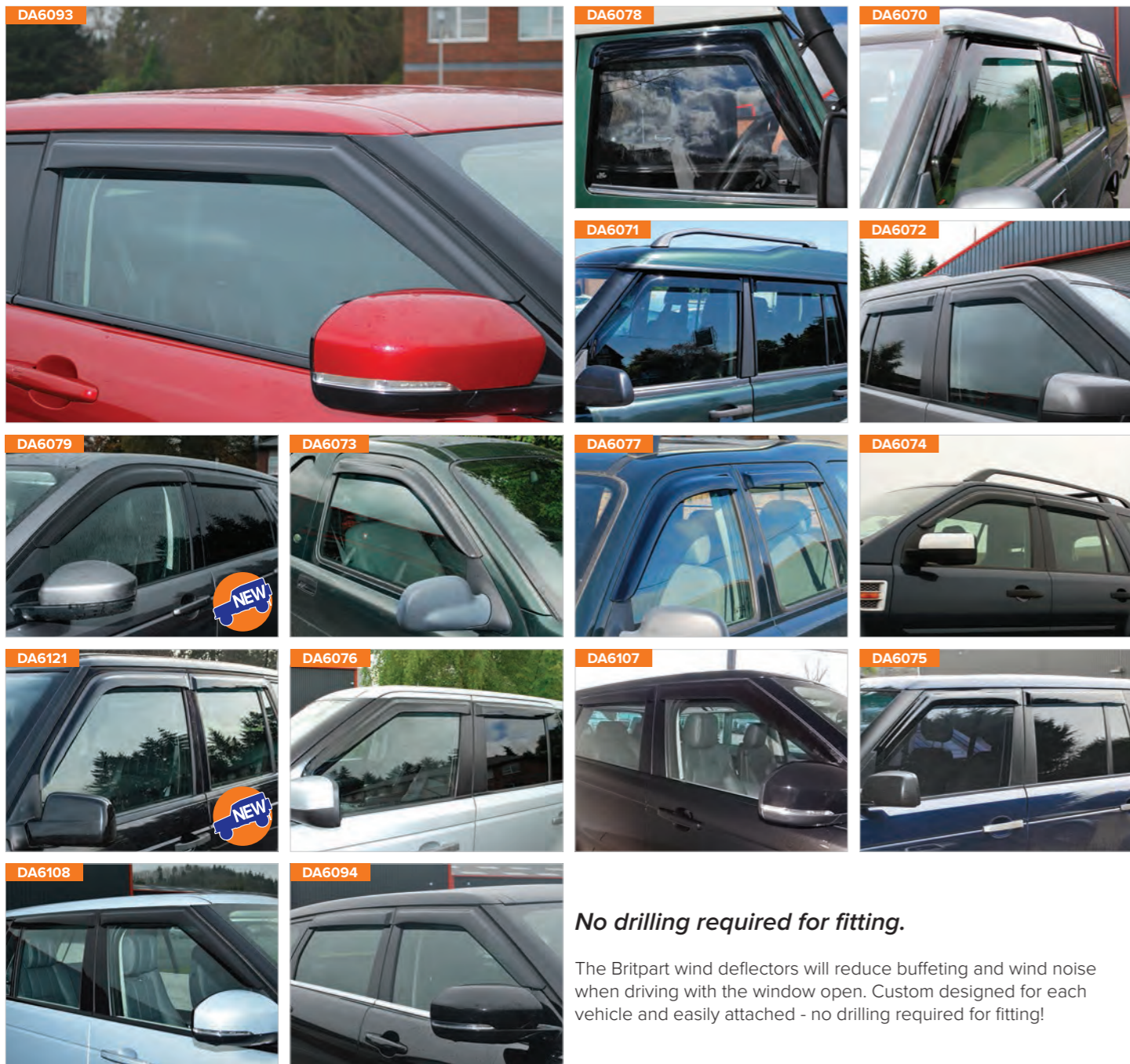

No drilling required for fitting.

The Britpart wind deflectors will reduce buffeting and wind noise when driving with the window open. Custom designed for each vehicle and easily attached - no drilling required for fitting!

DA6078	Defender/Series	Front	2 piece kit	DA6070	Range Rover Classic	Front & rear	4 piece kit
DA6070	Discovery 1	Front & rear	4 piece kit	DA6121 NEW	Range Rover P38	Front & rear	4 piece kit
DA6071	Discovery 2	Front & rear	4 piece kit	DA6076	Range Rover Sport - 2005 - 2013	Front & rear	4 piece kit
DA6072	Discovery 3/Discovery 4	Front & rear	4 piece kit	DA6107	Range Rover Sport - 2014 onwards	Front & rear	4 piece kit
DA6079 NEW	Discovery Sport	Front & rear	4 piece kit	DA6075	Range Rover L322	Front & rear	4 piece kit
DA6073	Freelander 1 - 2 door	Front	2 piece kit	DA6108	Range Rover L405	Front & rear	4 piece kit
DA6077	Freelander 1	Front & rear	4 piece kit	DA6093	Range Rover Evoque - 3 door	Front	2 piece kit
DA6074	Freelander 2	Front & rear	4 piece kit	DA6094	Range Rover Evoque - 5 door	Front & rear	4 piece kit

Defender Side Protectors



DA7012	Defender 90	Black with chequer plate top	Pair
DA7012SS	Defender 90	Stainless steel	Pair
DA7011	Defender 110	Black with chequer plate top	Pair
DA7011SS	Defender 110	Stainless steel	Pair

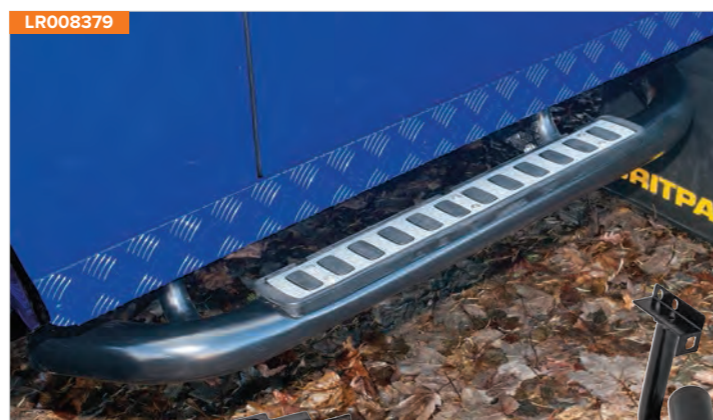

DA4101	Defender 90	Black with rubber top	Pair
DA4060	Defender 110	Black with rubber top	Pair
VPLDP0068	Defender 90	Twin tube - black with rubber top	Pair
VPLDP0067	Defender 110	Twin tube - black with rubber top	Pair

For rock sliders - see exterior protection section

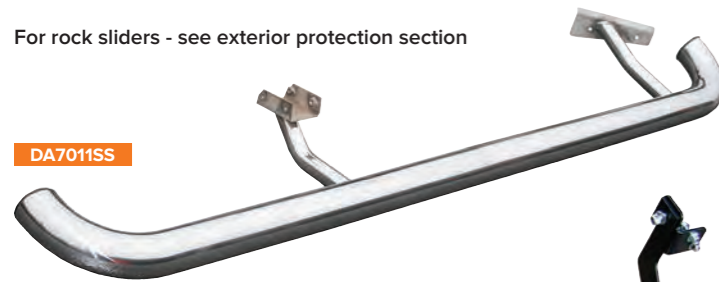

Side Steps

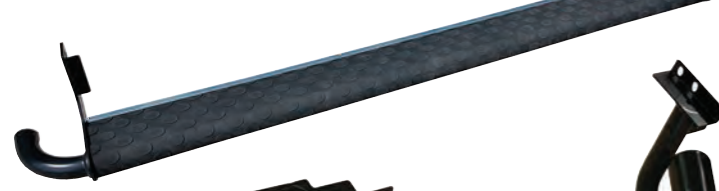

LR008379	Defender 90 - 2003 ->/Defender 110 - 2-dr pick-up - 2003 ->	Fire & Ice style - black with rubber and anodised aluminium top	Pair
LR008375	Defender 110 - 2003 -> - not 2-dr pick-up	Fire & Ice style - black with rubber and anodised black aluminium top	Pair
LR008379B	Defender 90 - 2003 ->/Defender 110 - 2-dr pick-up - 2003 ->	Fire & Ice style - black with rubber and anodised aluminium top	Pair
LR008375B	Defender 110 - 2003 -> - not 2-dr pick-up	Fire & Ice style - stainless steel with rubber and anodised aluminium top	Pair
LR008379SS	Defender 90 - 2003 ->/Defender 110 - 2-dr pick-up - 2003 ->	Black with rubber and anodised aluminium chequer plate top	Pair
LR008375SS	Defender 110 - 2003 -> - not 2-dr pick-up	Black with rubber and anodised aluminium chequer plate top	Pair
LR029295/7KIT	Defender 90 - 2003 ->/Defender 110 - 2-dr Pick-up - 2003 ->	Black with rubber and anodised aluminium chequer plate top	Pair
LR029294KIT	Defender 110 - 2003 -> - not 2-dr pick-up	Black with rubber and anodised aluminium chequer plate top	Pair

Defender - continued Side Steps



Photo courtesy of Jake Perks



STC7631	All models	Folding side step with rubber top	Single
STC7631MT	All models	Folding side step with rubber tyre tread top	Single
DA4814		Replacement rubber top with tyre tread pattern for STC7631	Single



Rear Steps

STC50269AA	Defender 90 - XA onwards	Rear step - includes regulation tow bracket
STC50301	Defender 110 - XA onwards	Rear step - includes regulation tow bracket
DA4070	All models	Rear tow ball step - double with zinc plated finish. Will also fit any vehicle with a drop plate tow hitch.
DA4070B	All models	Rear tow ball step - double with black finish. Will also fit any vehicle with a drop plate tow hitch.
STC7632	All models	Folding rear door step with rubber top
STC7632MT	All models	Folding rear door step with rubber tyre tread top
DA4818		Replacement rubber top with tyre tread pattern for STC7632



Freelander



STC53077

LR002773



STC7632



DA4070

Freelander 1	STC53077	Side steps	Black	Pair
Freelander 2	LR002773	Side steps	With thermo plastic elastomer side step top and a brushed aluminium side trim	Pair
	LR003318	Side protection tubes	Stainless steel	Pair

LR003318

Discovery

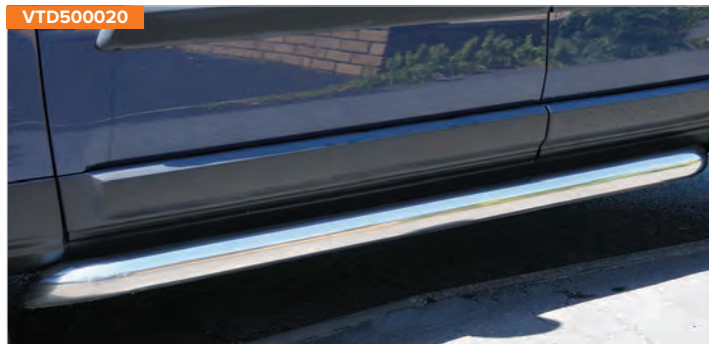

Discovery 1	STC8130AB	Side steps	Chevron tread	Pair
Discovery 2	DA8534 NEW	Side steps - including mudflaps	Chevron tread	Pair
	STC50032	Side steps - including mudflaps	Stainless steel	Pair
Discovery 3 / Discovery 4	VTD500010	Black steel side protection tubes		Pair
	VTD500020	Stainless steel side protection tubes		Pair
	VTK500010	Side steps - with polypropylene side step top and a brushed aluminium side trim		Pair
Discovery Sport	VPLCP0210LR	Side steps		Pair
	VPLCP0209LR	Side tubes		Pair



Discovery 1	RTC9505AC	Rear retractable step		
	RTC9593AA	Spare shock absorber for rear retractable step (RTC9505AC)		
Discovery 2	STC50290	Rear retractable step - up to 1A298103		
	KVL100040	Spare shock absorber for rear retractable step (STC50290)		

DA7533
Rock slider/side steps - pair
Discovery 3 & Discovery 4
The best of both worlds with these fitted to your Discovery!

Rock slider - an essential purchase for any off road use. They prevent damage to the underside sill of the vehicle and allow for safe passage over rocky and rough terrain.

Side step - users often fit side steps to enable easy access to and from the car - this is a problem when going off road as they bend, break and cause snagging. These are heavy-duty side steps made from 5mm steel plate with 50mm tube backed up by an additional 2 x 40mm tube supports. The joints are TIG welded for a smooth OEM finish. The other benefit of this rock slider/side step combo is that the outer 'bar' pushes away small trees and scrub from the bodywork of the vehicle. They can also be used to 'slide' around thick trees when grip is minimal. These units require no additional drilling just unscrewing and unclipping of the plastic OEM parts. Fitting should take 15 minutes each side. Grip tape supplied loose for optional fitment.

Range Rover



Range Rover Classic	STC8130AB	Side steps - black rubber		Pair
Range Rover P38	STC8505AA	Side steps		Pair
	Note	- Includes mudflaps		
Range Rover Sport - 2005 - 2013	VTK500020	Side steps		Pair
	Note	- With thermo plastic elastomer side step top and a brushed aluminium side trim		
Range Rover Sport - 2014 onwards	VPLGP0226 NEW	Side steps		Pair
	VPLWP0191 NEW	Powered side step		Left hand side
	VPLWP0192 NEW	Powered side steps		Right hand side
Range Rover L322	VUB001230	Stainless steel side protection tubes		Pair
	VUB002510	Black steel side protection tubes		Pair
	Note	- Can be fitted with or without front mudflaps		
	VUB503660	Side steps		Pair
	Note	- Including front mudflaps with EPDM (synthetic rubber) top and hard plastic trimming		
	VUB001300	Side step replacement insert moulding for VUB503660		Right hand side
	VUB001310	Side step replacement insert moulding for VUB503660		Left hand side
Range Rover L405	VPLGP0100 NEW	Stainless steel side protection tubes		Pair
	VPLGP0226 NEW	Side steps		Pair
	VPLWP0191 NEW	Powered side step		Left hand side
	VPLWP0192 NEW	Powered side steps		Right hand side
Range Rover Evoque	VPLVP0071	Stainless steel side protection tubes		Pair
	VPLVP0184	Stainless steel side protection tubes		Pair

Photo courtesy of David Marsh



Racks, Roll Cages & Ladders

Do you need some extra space for transporting items? Our wide range of roof racks, bike racks and luggage boxes are extremely strong and versatile allowing you to expand your load capacity. Roll cages also offer some extra protection and piece of mind whilst off-roading.

- Bike Racks** 28
- Ladders** 28
- Load Securing System** 35
- Roof Racks**
 - Britpart Expedition 31
 - Front Runner 29
 - Galvanised roof rack kits 29
 - Land Rover 30
 - Mont Blanc 30
 - Safety Devices 32 - 33
 - Thule 29
- Roll Cages** 34

Bike Racks



DA4118	Discovery 1 - mount to the spare wheel carrier & are easy to fit	4 Bikes
DA4119	Discovery 2 - mount to the spare wheel carrier & are easy to fit	4 Bikes
DA4121	Freelander 1 - mount to the spare wheel carrier & are easy to fit	3 Bikes
STC50063	Discovery 2/Discovery 3/Discovery 4/Range Rover Sport - 2005 - 2013	2 Bikes
VPLFR0091	Thule cycle carrier. Raised roof rails & crossbar kit required - more information Thule page	1 Bike
DA4316	'Scott' - cycle carrier - for more information see Mont Blanc page	1 Bike
DA4317	'Barracuda' - cycle carrier - for more information see Mont Blanc page	1 Bike

The Westfalia Cycle Carrier is an innovative and flexible system that allows you to transport your bikes easily, helping make your journey more relaxing and enjoyable. The Cycle Carrier is a highly versatile, foldable, towbar mounted, carrier system. Plenty more information and images at www.britpart.com/westfalia

DA5022
Westfalia towbar mounted cycle carrier - 2 bikes

DA5023
7-pin to 13-pin adaptor.
To use on vehicles with 7-pin towing electric sockets



Ladders



RBL0526SSS

Easy access to your roof rack.

DA1089	Defender 90/110 Series SWB/LWB	Galvanised
DA3073	Defender 90/110	Grey
DA3073B	Defender 90/110	Black
DA4710	Defender 90/110 Safety Devices	Black
STC50417	Defender 90/110	Black
STC50134	Discovery 2	Black
AGP780020LR	Discovery 3/Discovery 4	Black
RBL0526SSS		Black

A rear ladder mounted from Safety Devices' Defender 90 and 110 roll cage and Land Rover lower chassis mounting points.

Roof Racks



Galvanised Roof Rack Kits



Short Wheel Base Flat Packed Galvanised Roof Racks

Length - 1,990mm (78½")
Height - 420mm (16½")
Width - 1,460mm (57½")
Weight - 25kg

DA1093	Defender 90/Series SWB	Flat floor
DA1091	Defender 90/Series SWB	Contour floor

Long Wheel Base Flat Packed Galvanised Roof Racks

Length - 2,800mm (110½")
Height - 420mm (16½")
Width - 1,460mm (57½")
Weight - 30.5kg

DA1090	Defender 110/Series LWB	Flat floor
DA1092	Defender 110/Series LWB	Contour floor

DA1089 Ladder - for above kits Galvanised

Note - Contour racks must not be used on vehicles fitted with a sunroof.



Thule

Roof Bars
Maximum load weight of 80kg.
Complete with a pair of black square bars.

Gutter Mount Fitment

DA2990	Defender - 90/110	1,630mm wide
DA2990	Discovery 1	1,630mm wide
DA2991	Discovery 2 - with modified trim	1,630mm wide
DA3002	Range Rover Classic	1,500mm wide

Clamp Style Fitment

DA4328	Freelander 1 - 1998 - 2003 - 3-door & 5-door	1,200mm wide
DA4326	Freelander 2	1,350mm wide
DA2996	Range Rover Sport - 2005 - 2013	1,500mm wide
DA4330	Range Rover L322	1,500mm wide

Fixed Points Fitment

DA4325	Discovery 3	1,270mm wide
DA4325	Discovery 4	1,270mm wide
DA2993	Range Rover P38	1,200mm wide

Raised Roof Rail Fitment

STC7639	Discovery 1	1,200mm wide
DA4323	Discovery 2 - up to 2003	1,350mm wide
DA4324	Discovery 2 - 2004 onwards	1,270mm wide
DA4324	Discovery 3	1,270mm wide
DA4329	Freelander 1	1,080mm wide
STC7639	Freelander 1	1,200mm wide
DA4327	Freelander 2	1,270mm wide
DA4324	Range Rover Evoque - 5-door	1,270mm wide



Cycle Carrier
VPLFR0091

- > The smartest, most elegant solution for loading and transporting a bike on the roof.
- > The self-adjusting and upright frame holder into which the bike automatically slides, makes bike loading easy.
- > Adjusting and securing is done comfortably and quickly, with a turning knob, at roof height.
- > Quick-release straps, adjustable for different wheel sizes, hold the wheels securely in place.
- > Light and convenient aluminium design.
- > Can easily be fitted on either side of the car roof.
- > Lockable - bike to bike carrier, bike carrier to load carrier.
- > Fits frame dimensions up to 100mm.



Front Runner



- > All aluminium construction, fully welded
- > Powder coated finish
- > Patented slat, with grooves to accommodate 8mm bolts
- > Modular design - allow accessories to be mounted and removed as need without drilling
- > Rail towards the rear, open in the front
- > Gutter mount stainless steel clamps

DA3077	Freelander 1	Full rack	Silver
DA3086	Freelander 1 Original mountings	Full rack	Silver

Mont Blanc



Roof Bars & Rails
3 part roof bar kit which is tailored to suit the vehicle and easily fits to the roof with locks included.

DA4312	Discovery 3	Roof bar FlexiKit 3	Max load - 100kg	Weight - 4.5kg
DA4314	Range Rover Sport - 2005 - 2013	Roof bar FlexiKit 3	Max load - 100kg	Weight - 4.5kg
DA4319	Range Rover L322	Roof bar FlexiKit 3	Max load - 100kg	Weight - 4.5kg

For vehicles with factory fitted roof rails.

DA4311	Freelander 1	Roof bar FlexiKit 2	Max load - 100kg	Weight - 3.3kg
--------	--------------	---------------------	------------------	----------------

2 part roof bar kit which easily fits to the roof.

DA2311	Defender	Classic roof bars	Max load - 100kg	Weight - 5.0kg
DA2315	Range Rover P38	Classic roof bars	Max load - 100kg	Weight - 5.0kg

Universal fitting for vehicles with standard factory fitted roof rails.

DA2312	Discovery 1	Classic roof bars	Max load - 100kg	Weight - 3.4kg
DA2310	Freelander 1	Classic roof bars	Max load - 100kg	Weight - 3.3kg

Cycle Carriers
DA4316 'Scott' - cycle carrier
> Stable easy-to-use roof mounted cycle holder.
> Takes frame diameters from 30mm up to 80mm.
> Lockable to roof rack as well as bicycle.
> Frame holder with quick attachment for easy fitting without tools.
> Wheels rest in adjustable wheel holders and are fastened with strong securing straps.
> Can be fitted on all standard load bars and aluminium profiles.
> Maximum load - 17kg.



DA4316 'Barracuda' - cycle carrier
> Unique free stand feature enables ease of loading.
> Secured in the frame holder and locks to both bicycle carrier and roof bars.
> Chromium-plated frame holder tube in special steel.
> Base unit made of UV-resistant composite material.
> Takes frame diameters from 20mm up to 80mm.
> Manufactured in accordance with DIN 75302.
> Will fit to both standard and aluminium bars.
> CityCrash approved.
> Maximum load - 15kg.



For full technical specifications and more images - www.britpart.com/montblanc

Roof Boxes
DA4332 Vista 540 - full width
540 litres
2,000 x 950 x 420mm (L x W x H)
Weight - 17kg
DA4331 Vista 380 - half width
380 litres
2,000 x 650 x 450mm (L x W x H)
Weight - 15kg
> Lock up struts - new improved design with side opening for ease of loading.
> Three point central lock system.
> 80mm width fixings to suit most roof bar sizes.
> UV resistant, high impact ABS.
> Load securing straps included.
DA4333 Triton 450
430 litres
1,970 x 830 x 380mm (L x W x H)
Weight - 18kg
> Premium roof box range with modern design for all kind of activities.
> Made of UV-resistant ABS plastic with gas struts for soft opening and closing of box.
> Three point central locking.
> Load securing straps included.
> Flexible attachment to the load bar.
> Fits both square bars and aluminium bars with C-slots.
> Unique quick attachments - the box is attached from the inside.



Mont Blanc

Britpart Expedition



These roof racks are manufactured from aluminium with a smart black powder coated finish. Fully welded, they are extremely strong, versatile and easy to use. The floor plank profiles are orientated longitudinally which results in a reduction in wind noise. There are nut channels on all the extrusions to allow for easy fitting of accessories.

DA3072 Defender 90
3 feet per side
Weight - 32kg
Dimensions - 2,050mm long x 1,500mm wide
Vehicle gutter to top of rack - 265mm
DA3070 Defender 110
4 feet per side
Weight - 38kg
Dimensions - 2,750mm long x 1,500mm wide
Vehicle gutter to top of rack - 265mm
DA3269 Defender 110 Double cab pickup
Defender 130 Double cab pickup
3 feet per side
Weight - 27kg
Dimensions - 1,600mm long x 1,500mm wide
Vehicle gutter to top of rack - 265mm

DA6529 NEW Discovery 1 & 2
Low profile
3 feet per side
Weight - 26kg
Dimensions - 2,050mm long x 1,500mm wide
Vehicle gutter to top of rack - 265mm
Note - Will only fit vehicles without factory fitted roof rails.
DA6537 Discovery 3 & Discovery 4
4 feet per side
Weight - 23kg
Dimensions - 2,300mm long x 1,260mm wide
Roof to top of rack - 120mm
Note - May need roof rail kit (CAB500120PVJ or CAP500090) to be fitted to vehicle prior to roof rack installation.



More images online at www.britpart.com/expedition



Land Rover

Defender						
VPLDR0063	Defender 90	Roof rack	1,600mm	Range Rover	Range Rover P38	Roof ski carrier
VPLDR0064	Defender 110	Roof rack	2,400mm	LR006849	Range Rover Sport 2005 - 2013	Roof rack luggage carrier Expedition
STC7582	Defender - all models	Roof bars	Sports	CAB500130PMA	Range Rover Sport 2005 - 2013	Roof rack luggage carrier Expedition
Discovery				LR006848	Range Rover Sport 2005 - 2013	Roof rack luggage carrier
STC8057AC	Discovery 2	Roof bars	Sports	VUB502130	Range Rover Sport 2005 - 2013	Use in conjunction with roof cross bars and rails
VPLAR0001	Discovery 3/Discovery 4	Roof rack cross bars		LR006849	Range Rover Sport 2005 - 2013 & 2014 onwards	Roof ski carrier
LR006848	Discovery 3/Discovery 4	Roof rack luggage carrier		CAB500070PMA	Range Rover Sport 2005 - 2013 & 2014 onwards	Roof rack luggage carrier Expedition
LR006849	Discovery 3/Discovery 4	Use in conjunction with roof cross bars		LR006848	Range Rover L322	Roof rack luggage carrier
Freelander				LR006848	Range Rover L322	Use in conjunction with roof cross bars
STC50433	Freelander 1	Roof rack	Expedition	LR006849	Range Rover L405	Roof ski carrier
LR002417	Freelander 2	Roof rack cross bars		LR006848	Range Rover L322	Use in conjunction with roof cross bars
LR006848	Freelander 2	Roof rack luggage carrier		LR006849	Range Rover L405	Roof ski carrier
LR006849	Freelander 2	Use in conjunction with roof cross bars		LR006848	Range Rover Evoque	Use in conjunction with roof cross bars
		Roof ski carrier		LR006849	Range Rover Evoque	Use in conjunction with roof cross bars
		Use in conjunction with roof cross bars				

For images please visit - www.britpart.com/racks



Safety Devices



Defender 90 Hard Top and Station Wagon - Full Length Rack
Defender 110 Hard Top and Station Wagon - Three Quarters Length Rack
 3 roof cross rails as standard and can accommodate 2 additional roof cross rails.

DA4702	Short luggage rail	Gutter mount	2.0m x 1.4m	32kg
DA4712	Short luggage rail	Roll cage mount	2.0m x 1.4m	30kg
DA4703	Long luggage rail	Gutter mount	2.0m x 1.4m	32kg
DA4713	Long luggage rail	Roll cage mount	2.0m x 1.4m	30kg
DA4724 NEW	Full luggage rail	Gutter mount	2.0m x 1.4m	50kg
DA4723 NEW	Full luggage rail	Roll cage mount	2.0m x 1.4m	45kg
DA4704	Marine ply floor		2.0m x 1.4m	16kg

Defender 110 Hard Top and Station Wagon - Full Length Rack
 4 roof cross rails as standard and can accommodate 3 additional roof cross rails.

DA4705	Short luggage rail	Gutter mount	2.8m x 1.4m	42kg
DA4714	Short luggage rail	Roll cage mount	2.8m x 1.4m	40kg
DA4706	Long luggage rail	Gutter mount	2.8m x 1.4m	42kg
DA4715	Long luggage rail	Roll cage mount	2.8m x 1.4m	40kg
DA4725 NEW	Full luggage rail	Gutter mount	2.8m x 1.4m	55kg
DA4716 NEW	Full luggage rail	Roll cage mount	2.8m x 1.4m	50kg
DA4707	Marine ply floor		2.8m x 1.4m	23kg

Refer to owners handbook for recommended maximum weight.

Safety Devices Explorer Roof Rack Range

- > Heavy-duty steel roof rack.
- > Explorer roof racks can be affixed with a system of detachable roof cross rails to the rainwater gutters or with aluminium clamps to fit directly on to the majority of Safety Devices' external roll cages.
- > A rain gutter mounted roof rack can be converted into a roll cage mounted roof rack with the appropriate fitting kit.
- > The standard pack includes a steel roof rack, fixing bolts and optional roof cross rails.
- > Roof racks are grit blasted, primed with a zinc enriched powder undercoat, and finished with a durable black powder coat.
- > Not compatible with a sunroof.
- > Tents can normally be affixed to the roof rack without a floor, although a marine ply non-slip floor is also available.
- > Additional roof cross rails are available to purchase for use without a roof rack for use as, for example, a roof bar, basic tent support, attaching a roof storage box or to spread additional load on the Safety Devices' roof racks.



Defender 110 and 130 Double Cab/Crew Cab Pick-Up
 2 roof cross rails as standard and can accommodate 2 additional roof cross rails.
 Not compatible with ladders.

DA4708	Short luggage rail	Gutter mount	1.6m x 1.4m	26kg
DA4731 NEW	Full luggage rail	Roll cage mount	1.6m x 1.4m	30kg
DA4709	Marine ply floor		1.6m x 1.4m	12kg

Refer to owners handbook for recommended maximum weight.

DA4711	Additional roof cross rail	4kg
	Gutter mount	
DA4717 NEW	Additional roof cross rail	4kg
	Roll cage mount	
DA4710	Roof ladder	6.5kg

Mounts to rain gutter and cross-member.
 For use with DA4702, DA4703, DA4705 & DA4706



Short luggage rail with rain gutter mount, ideal for side loaded tents.
 Long luggage rail with rain gutter mount, ideal for front or back loaded tents.



Discovery 2
DA4732 NEW
 Discovery 2 with roof rails
 Highlander' roof rack for mounting to the rain gutter.
 Full luggage rail which neatly follows the profile of the vehicle's roof. 4 lamp brackets at the front, 1 at the rear.
 Roof rack will also fit with factory fitted 'oversized' roof bars. Weight: 29kg. Roof racks are grit blasted, primed with a zinc enriched powder undercoat, and finished with a durable black powder coat. Will allow limited use of the sunroofs although cannot be opened fully.
DA4733 NEW
 Marine ply floor for DA4732 (1 floor with 2 'levels' plus all stainless and galvanised hardware for mounting).
 Weight: 19kgs.

Safety Devices - continued



- Safety Devices 'G4 Expedition' Roof Rack Range**
- > An 'all in one' rack without detachable parts and a luggage rail which completely surrounds the roof rack.
 - > The roof rack neatly follows the profile of the roof to provide two floor levels and fixes to the rainwater gutter only. This roof rack cannot be fitted to a vehicle where an external roll cage has been fitted.
 - > Includes 4 spotlight brackets at the front and 1 spotlight bracket at the rear.
 - > Heavy duty steel roof rack, grit blasted, primed with a zinc enriched powder undercoat, and finished with a durable black powder coat.
 - > Does not allow a sunroof to be opened.
 - > Not compatible with a roof tent.
 - > Standard pack includes a steel roof rack and rain gutter fixing bolts.



Defender 90 Station Wagon or Hard Top

DA4718	1.9m x 1.2m roof rack with full luggage rail for mounting to rain gutter. Dimensions refer to the usable loading area.	30kg
	Marine ply floor (two floor levels)	
DA4719	Upper section - 1,220mm (w) x 1,405mm (l) x 10mm (h) Lower section - 1,220mm (w) x 540mm (l) x 10mm (h)	12kg
DA4722	Ladder which mounts to roof rack and chassis. Only suitable for attaching to DA4718 & DA4720	8kg

Defender 110 Station Wagon or Hard Top

DA4720	2.6m x 1.2m roof rack with full luggage rail for mounting to rain gutter. Dimensions refer to the usable loading area.	40kg
	Marine ply floor (two floor levels)	
DA4721	Upper section - 1,220mm (w) x 2,128mm (l) x 10mm (h) Lower section - 1,220mm (w) x 540mm (l) x 10mm (h)	15kg
DA4722	Ladder which mounts to roof rack and chassis. Only suitable for attaching to DA4718 & DA4720	8kg

Safety Devices®

For more Safety Devices roof rack images
www.britpart.com/safety-devices-racks



Photo courtesy of Jundío Salvador



Photo courtesy of Mike Cunliffe

Roll Cages



RBL1727SSS
Defender 90
RBL1387SSS
8 Point external front roll cage with internal rear roll cage Black
 Defender 90 Station Wagon without bulkhead, 2-door
RBL1087SSS
6 Point full external roll cage Black
 Defender 90 Station Wagon with bulkhead, 2-door
 Models between 1983 - 1988 had three raised ribs on the roof approx 22mm (7/8") tall. This kind of roof does not work with our external roll cages as the hoops will clash with them.
RBL2137SSS
6 Point full external roll cage Black
 Defender 90 Hard Top without bulkhead, 2-door
 Defender 90 Station Wagon without bulkhead, 2-door
RBL1887SSS
8 Point multi-point external/internal bolt-in roll cage Black
 Defender 90 Soft Top 2-door (1983-present)
 Utilises existing hood which will need modification. Front legs are NAS style.

Defender 110
RBL2057SSS
8 point multi-point bolt-in full roll cage Black
 Defender 110 Td5 Double Cab Pickup 4-door (1998-2006)
 With front external roll cage and rear internal roll cage
RBL1907SSS
Full external multi-point bolt-in roll cage Black
 Defender 110 Hard Top, 2-door
 Made to NAS specification
RBL1727SSS
8 Point full external / internal roll cage Black
 Defender 110 Station Wagon, 4-door
 The cage will not fit vehicles with the external ribs fitted on the roof, nor will it fit if the rear seat box is stepped in the rear corner. For clarification, see Safety Devices website.
RBL1727PAD NEW
Internal roll cage padding Black
 Defender 110 Station Wagon, 4-door
 Moulded polyurethane protective padding. 16mm thickness. 4 x 1,000mm lengths.
RBL2427SSS
8 Point full external roll cage Black
 Defender 110 Station Wagon, 4-door
 Models between 1983 - 1988 had three raised ribs on the roof approx 22mm (7/8") tall. This kind of roof does not work with our external roll cages as the hoops will clash with them.

RBL1857SSS NEW
10 point full external bolt-in roll cage Black
 Defender 110 Crew/Double cab pick-up 4-door - 1983 onwards
RBL2447SSS NEW
Heavy-duty hood stick set Black
 Defender 110 200Tdi soft top 2-door - 1990 - 1993
 Set completely replaces soft-top hood sticks. 45mm tube diameter, no diagonal, backstays to waist rail, includes front belt anchor points.

Freelander 1
RBL1506SSS NEW
14 point multi-point bolt-in competition internal roll cage for cross door bars Black
 Freelander 1 3-door & 5-door
 Rear roll cage has cross diagonal in backstays, harness bars, tunnel brace and lower backstays.



Photo courtesy of Kenneth Njihia

Safety Devices®

Defender 90, 110 & 130
RBL1383SSS
4 Point external front roll cage Black
 Defender 90 Station Wagon without bulkhead, 2-door
 Defender 90 Station Wagon with bulkhead, 2-door
 Defender 110 Station Wagon, 4-door
 Defender 110 Crew Cab/Double Cab Pick-up, 4-door
RBL2303SSS
Full external style bar Silver
 Defender 90 Hard Top with bulkhead, 2-door
 Defender 90 Hard Top without bulkhead, 2-door
 Defender 90 Station Wagon without bulkhead, 2-door
 Defender 90 Station Wagon with bulkhead, 2-door
 Defender 110 Hard Top, 2-door
 Defender 110 Station Wagon, 4-door
 Defender 110 Crew Cab/Double Cab Pick-up, 4-door
 Defender 130 Station Wagon, 4-door
 Defender 130 High Capacity Crew Cab Double Cab Pick-up, 4-door
RBL0526SSS
Ladder Black
 A rear ladder mounted from Safety Devices' Defender 90 and 110 roll cage and Defender lower chassis mounting points.

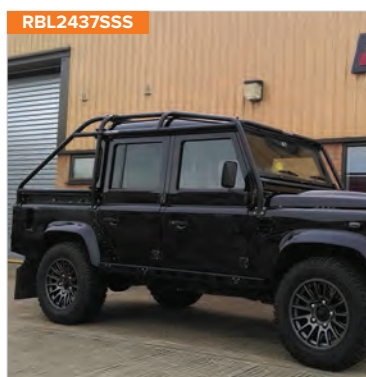

RBL2437SSS
RBL2437SSS NEW
6 point full external bolt-in roll cage
 Defender 110 - 2007 - 2015
 Double Cab Pickup 4-door

Load Securing System

BungeeClic Load Securing Starter Kit
DA5040
 > BungeeClic, a complete system for securing loads and objects.
 > It can be customised in a variety of ways to build the correct length ties needed for securing a variety of objects
 > It gives you all you need to build and adjust safe custom-length ties to suit your needs and requirements.
 > No more unsafe coupling or wrong lengths.
 > It can be used to secure loads at work, at home or out camping.
 > Min/max working load for all items - 0 - 80kg.
Kit Contents
 2 x J-hooks
 2 x Locking hooks
 1 x Straight connector
 1 x 90 - 135cm bungee cord
 1 x 60 - 90cm bungee cord
 1 x 30 - 45cm bungee cord



BungeeClic Additional Accessories
DA5041 BungeeClic J hooks - twin pack
DA5042 BungeeClic Locking hooks - twin pack
DA5043 BungeeClic Straight connectors - twin pack
 Straight connectors provide precision length for every job.
DA5044 BungeeClic Y connector - single pack
 Y connectors allow you to build netting shapes
DA5045 BungeeClic Wall mounts - twin pack
 The Wall mount offers solid and permanent anchoring; inside your Land Rover or behind any door.
DA5046 BungeeClic Adjustable hooks - twin pack
 The adjustable hooks let you quickly adjust and set the bungee cord the right length and position.
DA5047 BungeeClic 30cm cords - twin pack
 30cm extends up to 45cm
DA5048 BungeeClic 60cm cords - twin pack
 60cm extends up to 90cm
DA5049 BungeeClic 90cm cords - twin pack
 90cm extends up to 135cm
DA5050 BungeeClic 120cm cords - twin pack
 120cm extends up to 160cm



Customised in a variety of ways & used to secure loads at work, at home or out camping.



Photo courtesy of Callum Lang



Wheels

Smarten up your Land Rover with a new set of wheels! Our wide selection means that there is a design and colour to suit your needs. Make sure not to get caught out with a flat tyre with monitoring, maintenance and repair kits to keep your tyres in excellent condition.

- Spare Wheel Carriers** 38
- Spare Wheel Strap** 38
- Tyre Monitoring & Repair**
- Air compressors 38
- ARB tyre maintenance 39
- Inner tubes 38
- Tyre pressure monitoring system 38
- Tyre repair kit 38
- Valve Caps** 38
- Wheel Protection**
- Locking wheel nuts, keys & caps 40
- Spare wheel covers 40
- Spare wheel protectors 40
- Wheel Spacers & Adaptors**
- Wheel adaptor kits 40
- Wheel spacers 40
- Wheel Wrenches** 40
- Wheels**
- Alloy 42
- MaxXtrac 43
- MaxXtrac Blindo 43
- Steel 41
- Zu 44



Spare Wheel Carriers



- DA2232** Defender - all models/Series
Swing away rear door mount
- DA2274** Defender - with half door tailgate
Swing away rear door mount
- DA2274CABLE** Spare cable for DA2274
- DA2215** Defender/Series
Fixed rear door mount

Spare Wheel Strap

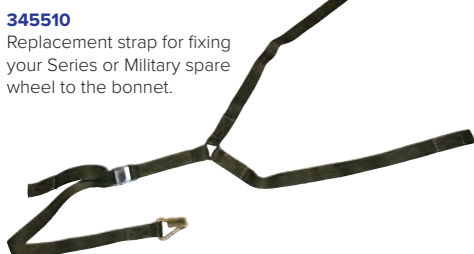

Inner Tubes

- DA3000** 7.50 x 16
Uses TR15 (large) type valve
- DA3201** 205 x 16
Uses TR13 (small) type valve

Valve Caps



- LR027664** Red, white & blue Union flag Set of 4
- LR027666** Black, white & grey Union flag Set of 4

Enhance your wheels with a set of smart aluminium valve caps.

Tyre Monitoring & Repair



DA4512
This system is an advanced monitoring & alert system of tyre conditions. It monitors tyre pressure and temperature then relays the state of each tyre to a display unit. When any abnormalities are detected, the system will display the status of the affected tyre and sound an alarm to ensure you take action to remedy the problem. Keeping your tyres in good condition at the right pressure can extend the life of your tyres, reduce fuel consumption and improve handling.
Note - This system will only measure up to a maximum of 3.5 bar.

Air Compressors



DA2392
Double-pump air compressor
Air flow - 150ltr/min
It's no good being able to repair your tyres if you can't inflate them. Full details of these air compressors can be found in the off-road section.



DA2354
Single-pump air compressor
Air flow - 72ltr/min

Tyre Pressure Monitoring System

- Tyres that are at the right pressure will -
- > Improve fuel consumption
 - > Increase the tyre life span
 - > Help enhance vehicle handling & braking
 - > Reduce susceptibility to hydroplaning

System contents -
1 x Display
1 x Receiver
4 x Tyre sensors
3 x Display brackets
2 x 3M stickers
1 x Instruction manual

Tyre Repair Kit



DA2390 - Tyre repair* kit in travel case
How It Works
1. Find and remove the item that caused the puncture.
2. Apply rubber solution to the reamer tool then push the reamer into the puncture and work up and down until the reamer moves easily in the hole.
3. Thread one rubber tyre plug in the hook tool.
4. Push the rubber tyre plug into the hole until 1/2" of the tyre plug remains outside the tyre then turn the hook tool a quarter turn and pull out slowly.
5. Cut off the excess tyre plug as close to the tyre as possible.
6. If the puncture is too big have the tyre fixed by a professional.
*Recommended for off-road use only.

ARB Tyre Maintenance



DA8927 NEW Tyre Inflator
> Compatible with ARB air compressors.
> Easy to read dial with dual scale PSI/bar increments.
> Quality bronze Bourdon tube gauge design.
> Fully geared, solid brass precision movement.
> Protective rubber gauge guard.
> Air bleed button for deflating.
> 330mm stainless braided flexible hose.
> Clip on chuck.
> Incorporates 1/4 NPT-US standard made air fitting.
> Internal air shut off valve.



DA8930 NEW Speedy Seal Puncture Repair Kit
Coming in a compact, high visibility carry case, the Speedy Seal includes all the components necessary to repair tubeless radial or cross ply tyres, without removing the tyre from the vehicle or rim. A pencil type tyre gauge with dual chuck makes setting pressures a snap, while a spring steel insertion needle and hardened reamer tool allow fast tyre repairs.
> Lubricant for easier tool insertion.
> Additional accessories (valve core tool, spare valves and valve caps).
> 30 self vulcanising repair cords for complete air sealing.
> Allen keys.



DA8931 NEW E-Z tyre Deflator
The unique, patented design of the E-Z Deflator allows for removal of the valve core for rapid tyre deflation, while also providing accurate pressure reading via the simple movement of a sliding valve. Provided in a protective canvas pouch, the quality bronze Bourdon Tube gauge design ensures accuracy is not affected by fluctuations in temperature, humidity or altitude.
> Corrosion resistant brass/stainless deflator tool.
> Fully geared, solid brass precision movement.
> Protective rubber gauge guard.
> Easy to read dial with one PSI increments.



DA6253 Tyre Inflation Kit
The ARB tyre inflation kit for air compressors is specially sourced from Japan, providing a unique high-heat tolerant hose for the hi-output compressor (DA4190). The practical kit includes a dust resistant air chuck and an enclosed internal bearing system to prevent dirt ingestion.
> Suitable for camping, touring and off-road applications as well as everyday usage.
> Provides fast, accurate inflation.
> Kit includes
1 x high heat pressure hose.
1 x ARB air chuck with quick press fitting.
1 x ARB T-fitting for use with the ARB air compressor (DA4190) and an assortment of additional fittings to suit various camping and sporting gear such as air mattresses and footballs.



4X4 ACCESSORIES



Photo courtesy of Vic Shield



Photo courtesy of Martin Port

Wheel Protection

Locking Wheel Nuts, Keys & Caps

Protect your valuable wheels & tyres

	Locking wheel nuts		Locking wheel nut keys
	Defender	Discovery 2	Defender
Code A	STC3410	STC3580	STC3420
Code B	STC3411	STC3581	STC3421
Code C	STC3412	STC3582	STC3422
Code D	STC3413	STC3583	STC3423
Code E	STC3414	STC3584	STC3424
Code F	STC3415	STC3585	STC3425
Code G	STC3416	STC3586	STC3426
Code H	STC3417	STC3587	STC3427
Code I	STC3418	STC3588	STC3428
Code J	STC3419	STC3589	STC3429

	Locking wheel nuts	Locking wheel nut keys
	Freelander 1 - up to 2006	Freelander 1 - up to 2006
Code A	RRD100520	KBM100450
Code B	RRD100530	KBM100460
Code C	RRD100540	KBM100470
Code D	RRD100550	KBM100480
Code E	RRD100560	KBM100490
Code F	RRD100570	KBM100500
Code G	RRD100580	KBM100510
Code H	RRD100590	KBM100520
Code I	RRD100600	KBM100530
Code J	RRD100610	KBM100540

Spare Wheel Covers



Plain black, easy to fit spare wheel covers.

DA2021	7.5 x 16
DA2022	6.0 x 16 & 19.5 x 80 x 15
DA2026	205 x 16
DA2025	235 x 70 x 16 & 255 x 55 x 18
DA2027	235 x 85 x 16



facebook.com/britpart

Wheel Adaptors & Spacers

Wheel Adaptors

Convert your existing stud pattern to allow for fitment of a different style of wheel.



DA6343

Set of 4
To fit Range Rover L322 or Range Rover Sport wheels to a Discovery 2 or Range Rover P38.

DA5005



To fit Range Rover P38 wheels to Defender, Discovery 1 or Range Rover Classic
Boss height is 66.65mm

DA5005 Set of 4
DA5005S Single adaptor

DA5006



To fit Discovery 2 wheels to Defender, Discovery 1 or Range Rover Classic
Boss height is 58mm

DA5006 Set of 4
DA5006S Single adaptor

Spare Wheel Protectors



The valuable spare wheel on the Discovery 3, Discovery 4 and Range Rover Sport - 2005 - 2013 are very vulnerable to theft. These spare wheel protectors are designed to restrict access to the winching mechanism and makes it almost impossible for anyone to steal the wheel. Easy to fit, with full instructions, to give you piece of mind.

DA1156
Aluminium
DA1360 NEW
Steel

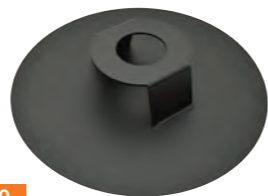

DA1360

Wheel Spacers

Improve your Land Rover's appearance, steering lock & handling with a set of wheel spacers.



Defender/Discovery 1/Range Rover Classic
30mm thick, steel machine finish complete with wheel nuts and OEM studs
DA5004 Set of 4
DA5004S Single spacer

Wheel Wrenches



218508

NTC7829HD

DA4026

537179

537179 Wrench size - 1 5/16"
DA4026 Wrench size - 27mm
NTC7829 Wrench size - 27mm
NTC7829HD Wrench size - 27mm - heavy-duty
LR011870 Wrench size - 27mm
LR011870HD Wrench size - 27mm - heavy-duty
218508 Starting handle for Series vehicles

Wheels

Steel Wheels



Smarten up your Land Rover with a smart set of new wheels.

Defender	Discovery	Freelander	Range Rover Classic
ANR4583PM	DA3187	ANR3973	ANR4635PM
ANR4583SILVER	NTC5193PM		ANR4636PM
VPLDW0095PVT NEW			DA3187
ANR4635PM			RRC503600PM
ANR4636PM			
ANR5593PM			
DA3187			
RRC503600PM			

Series	Discovery	Freelander	Range Rover Classic
ANR4636PM	DA3187	ANR3973	ANR4635PM
	NTC5193PM		ANR4636PM
			DA3187
			RRC503600PM



Sign up to the regular Britpart newsletter to find out about all the latest product releases.
www.britpart.com/newsletter

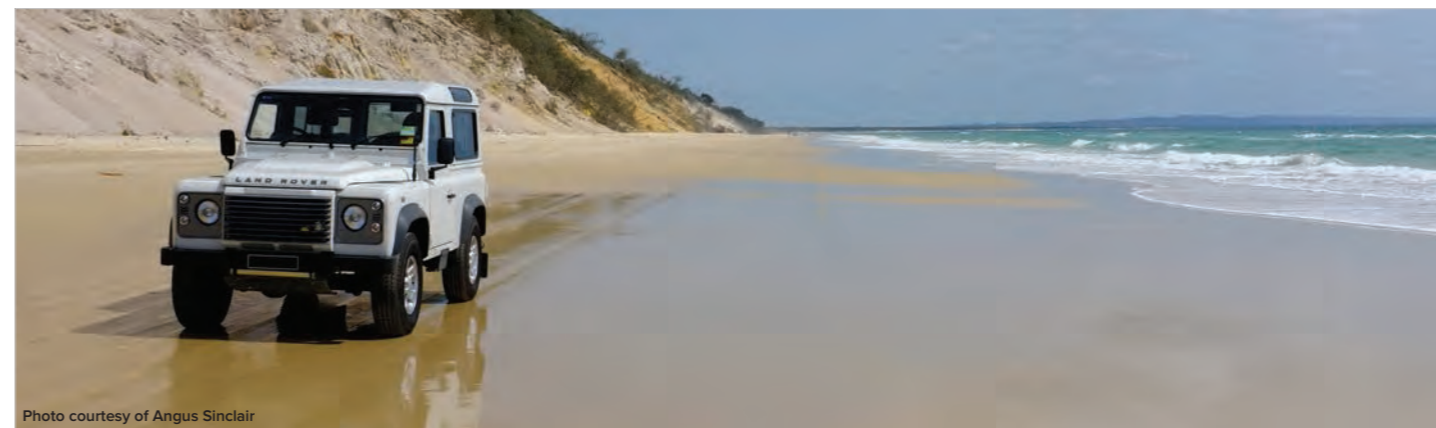

Photo courtesy of Angus Sinclair

Alloy Wheels



Defender			
ANR3631MNH		16" x 7	Deep Dish alloy
ANR5307MNH	TA onwards	16" x 7	Tornado alloy
RRC503400MNH	1994 onwards	16" x 7	Boost alloy
LR023391BLK	1994 onwards	16" x 7	Boost alloy - black gloss
Sawtooth style alloys			
ET20 / Load 1,000kg / JWL tested / Defender PCD / Standard wheel nuts			
LR025862	1994 onwards	16" x 7	Black
LR025862MNH NEW	1994 onwards	16" x 7	Silver
DA6548 NEW	1994 onwards	18" x 8	Black
DA6549 NEW	1994 onwards	18" x 8	Silver

Discovery			
ANR3631MNH	Discovery 1	16" x 7	Deep Dish alloy
ANR5307MNH	Discovery 1	16" x 7	Tornado alloy
RRC501470MCM	Discovery 2	18" x 8	Hurricane alloy
RRC505360MNH	Discovery 3/Discovery 4	18" x 8	10-spoke alloy Silver sparkle finish

Range Rover			
RRC501470MCM	Range Rover P38	18" x 8	Hurricane alloy
RRC505360MNH	Range Rover Sport - 2005 - 2009	10-spoke alloy	
		18" x 8	Silver sparkle finish
RRC505370MNH	Range Rover Sport - 2005 - 2009	10-spoke alloy	
		19" x 9	Silver sparkle finish

Note - Centre caps and wheel nuts not included with any wheels.

Smarten up your Land Rover with a smart set of new wheels.



Note - It is the responsibility of the vehicle owner to ensure that the wheels fitted to their vehicle have an appropriate load rating. The minimum required load rating can be determined by taking the manufacturers recommended maximum axle weight and dividing by two.

MaxXtrac - Mach 5



MaxXtrac Mach 5 alloy wheels

Defender
Discovery 1
Range Rover Classic

Engineered in the UK & supplied with 5 standard wheel nuts.

- > Size - 16" x 8
- > Offset - et 10
- > Load rating - 1,450kg

	Wheel	Wheel Centre
Satin Black	DA2471	DA2476
Anthracite	DA2472	DA2478
Silver	DA2473	DA2477
DA2474	Set of 5 spare wheel nuts	
DA2475	Set of 5 locking wheel nuts	

MaxXtrac - Blindo



Defender/Discovery 1/Range Rover Classic

Specifications

- > Size - 16" x 7"
- > PCD - 5 x 165.1
- > Offset - et 15
- > Weight - 14.3kg

DA2488	Anthracite
DA2489	Black
ANR2763MMM	Wheel nut
	Single



Smart looking, tough, high quality alloy wheels which are ideal for off-road use. Used for rally-road competition vehicles as well as the military these Blindo wheels are TÜV approved and manufactured in Italy.

- > Only prime aluminium is used.
- > Less silicon is added than cheaper alloy wheels.
- > Alloys are heat-treated for improved mechanical properties.
- > Metal is de-gassed to remove any small bubbles.
- > Low pressure cast to ensure improved metal density.
- > Once made each alloy is x-rayed to check for defects, then water tank pressure tested to ensure no leaks.



Photo courtesy of Daniel Magee

Note - It is the responsibility of the vehicle owner to ensure that the wheels fitted to their vehicle have an appropriate load rating. The minimum required load rating can be determined by taking the manufacturers recommended maximum axle weight and dividing by two.

Zu Wheels

- > Super strong
- > Super Light
- > TÜV approved and meets or exceeds UK - European - U.S. - Canadian - Australian - South African and Japanese wheel manufacturing specifications
- > Uses standard Land Rover alloy wheel nuts
- > Easy to balance
- > Manufactured in the UK

Defender/Discovery 1/Range Rover Classic

- 16 x 7 Rims**
- > 11mm + VE offset
 - > 1,400kg rating
 - > 10.4kg each
- | | |
|---------------|--------------------|
| DA2437 | Anthracite - gloss |
| DA2436 | Black - gloss |
| DA2439 | Black - matt |
| DA2435 | Silver |
| DA2434 | White |
- Note** - Wheel nuts not included

- ANR2763MMM** Alloy wheel nut
Defender - up to 2006/Discovery 1/Range Rover Classic
- RRD500560** Alloy wheel nut
Defender - 2007 onwards

Discovery 2/Range Rover P38

- 16 x 8 Rims**
- > 38mm + VE offset
 - > 1,400kg rating
 - > 12.0kg each
- | | |
|---------------|--------------------|
| DA2433 | Anthracite - gloss |
| DA2432 | Black - gloss |
| DA2438 | Black - matt |
| DA2431 | Silver |
| DA2430 | White |

- 18 x 8 Rims**
- > Part number includes wheel adaptor ring
 - > 36mm + VE offset
 - > 1,400kg rating
 - > 12.0kg each
- | | |
|---------------|--------------------|
| DA2458 | Anthracite - gloss |
| DA2459 | Anthracite - matt |
| DA2456 | Black - gloss |
| DA2457 | Black - matt |
| DA2461 | High Power Silver |
| DA2460 | Silver |
- Note** - Centre caps and wheel nuts not included

- RRD500510** Alloy wheel nut
- LR001156LR** Wheel cap
Discovery 2/Range Rover P38

Discovery 3/Discovery 4*/Range Rover Sport* & Range Rover L322*

- 18 x 8 Rims**
- > 36mm + VE offset
 - > 1,400kg rating
 - > 12.0kg each
- | | |
|---------------|--------------------|
| DA2452 | Anthracite - gloss |
| DA2453 | Anthracite - matt |
| DA2450 | Black - gloss |
| DA2451 | Black - matt |
| DA2455 | High Power Silver |
| DA2454 | Silver |

Note - Centre caps and wheel nuts not included

***Note** - Zu rims will not fit any Range Rover L322 Supercharged or Range Rover Sport Supercharged fitted with Brembo brake callipers. Will only fit Discovery 4 with 2.7ltr engine.

- RRD500590G** Alloy wheel nut
Discovery 3/Discovery 4/Range Rover Sport - 2005 - 2013
- RRD000011** Alloy wheel nut
Range Rover L322
- LR001156LR** Wheel cap
Discovery 3/Discovery 4
Range Rover Sport - 2005 - 2009/Range Rover L322



Super **Strong**
Super Light

Lighting

Our wide selection of lights allow you to replace broken lights or upgrade your existing lights to something more powerful. These lights will help you be better seen on the road and ensure that you can clearly see what is ahead of you. We also have inspection lights to help increase visibility when looking under your Land Rover's bonnet.

Exterior Lights	
Driving lights	46
Fog lights	46
Roo-lites	47
LED Bumper	47
LED Light Bars	50
Light Conversion & Upgrades	
Britpart Lynx Eye LED headlamps	49
ECE LED headlamps	49
Heater control light upgrade kit	49
Individual lights - LED	48
Light kits	47
Light upgrade kit	49
Replacement headlamps	48
Xenon headlight bulbs	49
Xenon headlight upgrade	49
Light Mountings	
Light bars	50
Light mounting kits	50
Spare Light Bulb Kits	49
Work lights	
Exterior lights	51
Inspection lamps	51

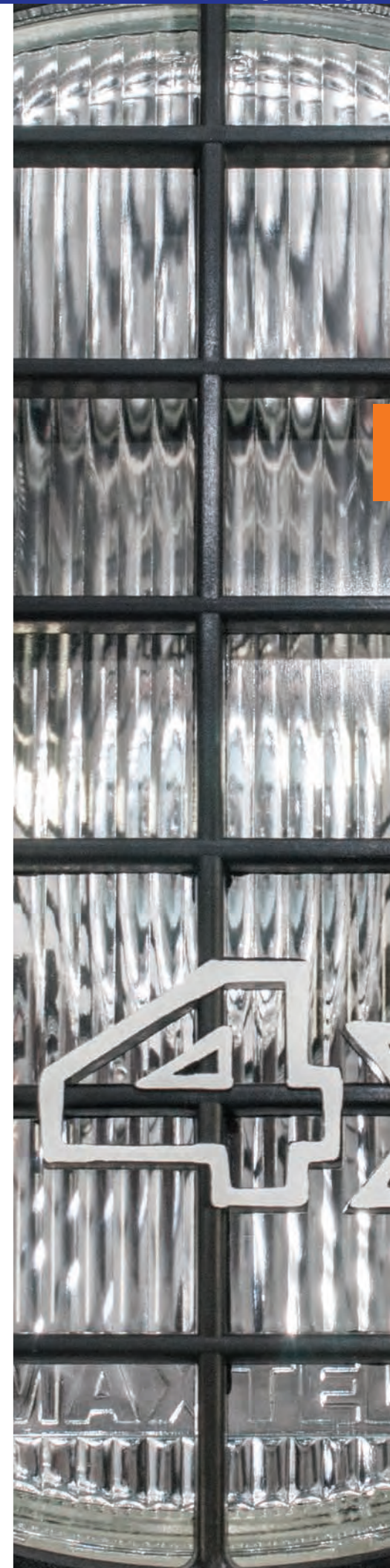

Note - It is the responsibility of the vehicle owner to ensure that the wheels fitted to their vehicle have an appropriate load rating. The minimum required load rating can be determined by taking the manufacturers recommended maximum axle weight and dividing by two.

Exterior Lights



- > 100 watt
- > Universal fitting
- > High power halogen lamps
- > Fits all 12 volt vehicles
- > Easy installation
- > Armoured cable
- > Fitted plastic stone guards
- > Excludes wiring kit

DA4088	8" Light	Black	Pair
DA4088C	8" Light	Chrome	Pair
DA4088W	Wipac 8" Light	Black	Pair

DA4088BULB
Replacement 100 watt bulb for DA4088; DA4088C & DA4088W

DA4088COVER
Replacement cover for DA4088; DA4088C & DA4088W



Fog Lights



RTC8922
Defender - up to 2006/Range Rover Classic
Hella Comet 550
Rectangular
Black Pair

STC7643
Defender - up to 2006/Discovery 1/Discovery 2
Hella Rallye 1000
Round
Black Single

DA4398
Replacement guard for STC7643
Solid
White Single

DA4399
Replacement guard for STC7643
Mesh
Black Pair



Driving Lights

DA4099	Hella Rallye 3000	Black	Single
PRC8238	Spoiler lamps classic	Black	Pair
STC7644	Hella Rallye 1000 long range	Black	Single
	Safari 5000	Black	Single
STC8480LR	Defender - 1987 - 2006/Discovery 1/Discovery 2/Range Rover Classic - 1992 - 1994/Range Rover P38		
XQB500080	Discovery 3	Driving light kit - includes electrics	Black Pair

Replacement Light Guards

DA4398	For STC7644	Solid	White	Single
DA4399	For STC7644	Mesh	Black	Pair



Photo courtesy of Kristian Kristjansson



Cibié LED Spot Lights
DA6502 NEW Cibié spot light - single
High performance with a large, homogeneous beam
> Includes one Oscar LED lamp with wiring, mounting hardware, installation instructions, white protective cover with CIBIÉ logo and CIBIÉ sticker.
> Coated polycarbonate lens is waterproof, shock resistant, corrosion resistant and UV resistant.
> Luminous flux - 700lm
> Voltage - 12-24V DC
> Light temperature - 6,000K
> Candelas - 75,000 cd
> Length of visibility - 370m
> Width of visibility - 40m
> Safety certification - ECE/SAE/CCC

DA6503 NEW
Replacement Cibié cover
Pair



Roo-Lites



DA1062 Roo-Lite
> High performance lighting with super strength construction.
> 7¼" round long range spot lamps with "stone-proof" clear polycarbonate lens.
> Super strength housing with an Osram 100 watt Xenophot long life technology bulb.
> Variable focus from spot to fog beam pattern.
> Lightweight for reduced vibration.
> Reflector unit is screw-on for easy bulb change.
> 12V - 100W - 8 amps.
Note - Roo-lites sold individually

Roo-Lite impact resistant covers
Plain
DA1062AMBER Amber
DA1062BLUE Blue - produces 'Xtra white' light
Diffused - suitable for fog/snow conditions
DA1062FOGA Amber
DA1062FOGW Blue - produces 'Xtra white' light
DA1062COVER Protective cover
Note - Roo-Lite covers sold individually
DA1063 100W Spare bulb
DA1064 Harness
Harness is of a heavy gauge wire to ensure safe operation of high wattage lamps. It includes digital switch, in-line fuse, built-in relay and wiring harness.

Exclusive to Britpart

High performance lighting with super strength construction



LED Bumper

This smart and functional standard fit Defender bumper is equipped with a pair of LED lights for additional lighting in the dark or day light running for safety.

DA5678
Front bumper with LED lights

Light Conversion & Upgrades

Defender & Series Replacement 73mm light kits
DA1077 Series/Defender - up to 300Tdi
DA1077G OEM Series/Defender - up to 300Tdi
DA1080 Defender - 300Tdi onwards
Defender - Td5 - up to WA159806
DA1080G OEM Defender - 300Tdi onwards
Defender - Td5 - up to WA159806

Defender & Series LED 73mm light kits
DA1191 Clear LED light kit
Contents - 2 x Clear front sidelight; 2 x Clear front indicator; 2 x Clear rear indicator; 2 x Clear stop/tail & 1 x 12v LED flasher unit
DA1192 Colour LED light kit
Contents - 2 x Clear front sidelight; 2 x Amber front indicator; 2 x Amber rear indicator; 2 x Red stop/tail & 1 x 12v LED flasher unit
DA1291 NEW Clear deluxe LED light kit
As per DA1191 kit with clear reverse light, clear fog light and number plate light.
DA1292 NEW Colour deluxe LED light kit
As per DA1192 kit with clear reverse, red fog light and number plate light.

Defender North American specification (NAS) LED upgrade kit

DA1143 Full kit Colour
DA1143CL NEW Full kit Clear
These stylish and waterproof NAS style LED rear lamps are a brighter alternative to the traditional halogen lighting with the added additional benefits of having a longer life (typical LED life 100,000 hours) with low energy consumption. The complete LED lamp kit includes
> 1 x reverse LED light
> 1 x fog LED light
> 2 x indicator LED lights
> 2 x stop/tail LED lights
> 6 x plinths & screws & smart load devices
DA1274 NEW Front kit Colour
DA1274CL NEW Front kit Clear
DA114424V 24 volt smart load device kit
Note - To use the LED kit (DA1143) on a 24 volt Defender use DA114424V which replaces the 12 volt smart load device.



Light Kits



Individual Lights - LED

Defender & Series LED lights

- > High quality LED lights
- > Multi-voltage 9 - 33V
- > 73mm diameter
- > Wipac branded
- > Waterproof to IP67
- > E Marked and SAE Approved
- > AMP type connector fitted
- > Comes complete with stainless steel screws

Defender - 1987 - 2006 & Series 2 & 3

AMR6514LED	Front side	Clear	Single
XBD100670LED	Front indicator	Clear	Single
AMR6515LEDCL	Rear indicator	Clear	Single
AMR6513LED	Front indicator	Amber	Single
AMR6515LED	Rear indicator	Amber	Single
XFD100100LEDCL	Stop/tail	Clear	Single
XFD100100LED	Stop/tail	Red	Single

Defender - 2007 onwards

XBD500050LED	Front side	Clear	Single
LR048189LED	Front indicator	Clear	Single
XBD500010LED	Front indicator	Clear	Single
LR047798LED	Rear indicator	Clear	Single
XFD500050LEDCL	Rear indicator	Clear	Single
LR048187LEDCL	Front indicator	Amber	Single
XBD500040LED	Front indicator	Amber	Single
LR048188LED	Rear indicator	Amber	Single
XFD500050LED	Rear indicator	Amber	Single
LR048187LED	Rear indicator	Amber	Single
XFD500040LEDCL	Stop/tail	Clear	Single
LR048200LEDCL	Stop/tail	Clear	Single
XFD500040LED	Stop/tail	Red	Single
LR048200LED	Stop/tail	Red	Single
XFE500010LED	Fog - 95mm	Red	Single
LR048201LED	Fog - 95mm	Red	Single
XFE500010LEDCL	Fog - 95mm	Clear	Single
LR048201LEDCL	Fog - 95mm	Clear	Single
LR048202LED NEW	Reversing	Clear	Single
XFC100550LED	Number plate	Clear	Single



LED Side Repeaters - Defender - Td5 onwards

DA8530 NEW	Clear	Pair
DA8531 NEW	Smoked	Pair
DA8532 NEW	Amber	Pair



Defender 95mm Special Edition lights

LR008982	Reverse LED	Clear	Single
LR009792	Indicator	Clear	Single
LR008913	Stop/tail LED	Clear	Single
LR008975	Fog LED	Clear	Single

Note - LR008982 & LR008975 require additional wiring - LR009711. LR008913 require additional wiring - LR101368.



12v LED flasher unit

Upgrade the standard flasher unit to the exclusive Wipac LED version. Manual adjustment to correct flasher rate. Can be used with any combination of LEDs and halogen bulbs - with or without additional loads such as trailers.



facebook.com/britpart

www.britpart.com

Replacement Headlamps

Replacement headlamps for Series, Defender & Range Rover Classic

Crystal halogen headlamp

> Clear lenses and profiled back reflector offer brilliant lighting.		
> Fully E-marked.		
RTC4615C NEW	Right hand drive - Britpart	Pair
RTC4615CW	Right hand drive - Wipac	Pair
PRC7994C NEW	Left hand drive - Britpart	Pair
Note - Bulbs not included		
589783	Bulb - 60/55W H4	Single

Sealed beam to halogen headlamps with bulbs

RTC4615K	Right hand drive	Pair
PRC7994K	Left hand drive	Pair

Wipac with bulbs

RTC4615KW	Right hand drive	Pair
RTC4615W	Right hand drive	Single
589783	Replacement bulb 60/55W H4	Single



Many more images available at www.britpart.com/lights

Defender North American specification (NAS) lights

AMR6526	Stop/tail	Red	Single
AMR6527	Indicator	Amber	Single

Note - Supplied without mounting plinth and screws.

AMR6528 Reverse Clear Single

Note - Supplied with mounting plinth but without screws.

XFD500010 Reverse Clear Single

XFE500010 Fog Red Single

Note - Supplied with mounting plinth and screws.

Defender NAS LED lights

AMR6526LED	Stop/tail LED	Red	Single
AMR6527LED	Indicator LED	Amber	Single
AMR6526LEDCL	Stop/tail LED NEW	Clear	Single
AMR6527LEDCL	Indicator LED NEW	Clear	Single
XFD500010LED	Reverse LED	Clear	Single
XFE500010LED	Fog LED	Red	Single
XFE500010LEDCL	Fog LED	Clear	Single
DA1273 NEW	Front side LED	Clear	Single



Sundry items

DA4349	ABS plastic NAS tail light guard	Single
AMR3850	Mounting plinth	Single
SE105161L	Screws	Pack of 10
STC1188	Link leads	
STC4637	Link leads	
DA114412V	12 volt smart load device kit	
DA114424V	24 volt smart load device kit	
Note	- To use the LED kit (DA1143) on a 24 volt Defender use DA114424V which replaces the 12 volt smart load device.	

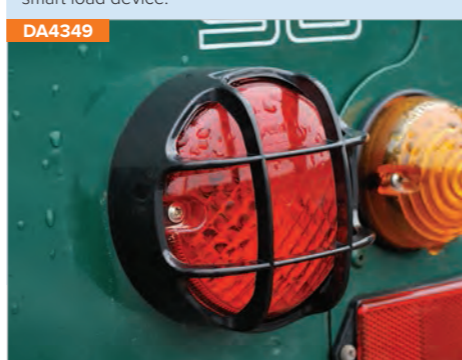

Heater Control Light Upgrade Kit



Restore the Range Rover P38's heater control unit back to full brightness with this Britpart kit. Full fitting instructions are included.

Britpart Lynx Eye LED Headlamps NEW



Right hand drive pair
Left hand drive pair
Standard 7" fitment for Defender, Series & Range Rover Classic. Durable polycarbonate lens & die-cast aluminium housing provide maximum protection

- General Specifications**
- > Lens material: Polycarbonate
 - > Housing material: Die-cast aluminium
 - > Mounting: Replaces PAR56 headlights
 - > Mounting connector: H4 and H4 to H13 converter
 - > Colour temperature: 6000-6500K
- Technical Specifications**
- > Low beam: 2.5 amps @12V DC
 - > High beam: 2.00 amps @ 24V DC
 - > Low beam: 1.25 amps @ 24V DC
 - > Row lumen output: 5600LM
 - > Effective lumen output: 3640LM

ECE LED Headlamps



- Features & Benefits**
- > ECE & ROHS compliant.
 - > LED sealed beam technology with polycarbonate lens and sealed electronics.
 - > Up to 50 x longer life than halogen headlamps, lowering life-cycle costs.
 - > Produces pure white light, nearly identical to daylight that is easy on the eye, unlike harsh blue HID systems.
 - > Includes built-in position lamp with optional wiring.
 - > Offers great forward vision, improved roadside coverage and highly controlled beam patterns, offering glare protection to oncoming traffic.
 - > Dipped/passing beam and main/driving beam functionality.
 - > Ultra-bright output for maximum night visibility.
 - > H4, 3-Blade connector system (main & dipped beam only).

Light Upgrade Kit



Convert your early Range Rover P38's standard orange indicator lights to the later, more stylish white indicator lights with this upgrade kit

STC50383 Right hand drive

STC50408 Left hand drive

Note - Does not include headlamps

Xenon Headlamp Bulbs



DA5052 NEW	Ultima	H1 fitment	Pair
DA5016	Ultima	H4 fitment	Pair
DA5016-130 NEW	Xenon 130	H4 fitment	Pair
DA5024	Ultima	H7 fitment	Pair
DA5024-130 NEW	Xenon 130	H7 fitment	Pair
DA5053 NEW	Ultima	H11 fitment	Pair

- > Ultima - up to 120% more light on the road.
- > Xenon 130 - up to 130% more light on the road.
- > 100% Xenon gas and advanced filament technology produce exceptional night driving performance.
- > A longer beam pattern enables other road users to be seen more clearly and allows more time to react to potential hazards.
- > Better reflections from road markings and signs make for more comfortable and safer night driving.
- > Street legal and a simple upgrade from standard bulbs, requiring no changes to vehicle wiring.

Xenon Ultima Headlamp Upgrade



Xenon 7" universal fit headlamp upgrade kit includes Xenon Ultima. Suitable for Defenders, Series and Range Rover Classic. Xenon Ultima is the first auto bulb to put 120% more light on the road. The lamps have a complex surface to give a superior light distribution. They are E-approved, fully road legal and the kit includes headlamp units and xenon bulbs. 3 year warranty.

DA5014	Right hand drive	Pair
DA5015	Left hand drive	Pair
DA5016	H4 replacement headlight bulbs for DA5014 & DA5015	Pair

Spare Light Bulb Kits



LED Light Bars **NEW**



DA6284 NEW
500mm LED light bar - single
Size - including bracket
H 98mm x W 574mm x D 91mm
Function - Combination beam
Watts - 90W
Light source - 30 x 3W LED
Light output - 7,500 Lumens



DA6295 NEW
120mm LED light bar - single
Size - including bracket
H 98mm x W 174mm x D 91mm
Function - Spot beam
Watts - 18W
Light source - 6 x 3W LED
Light output - 1,500 Lumens

- > Housing - aluminium extrusion with black electrophoretic coating.
- > Bracket - adjustable heavy-duty stainless steel.
- > Lens - Clear polycarbonate.
- > ECE Approved.
- > Long life/Low power
- > Dual voltage - 12/24V
- > Waterproof rating - IP67



Light Mountings



DA5624
Defender - non-air-con
Note - Light bar excludes lights



STC50243
Discovery 2
Note - Light bar excludes lights DA4088



Light Mounting Kits

Replacement plastic bowls for standard 8" headlight mountings on Defenders & Series.

DA3010	8" Headlamp	Single with chrome bezel
DA3010B	8" Headlamp	Single with black bezel
DA1158	8" Headlamp fixing kit - less bowl	Single Black bezel
STC3018SS	8" Headlamp mounting bezel	Single Stainless steel



Work Lights

Exterior Lights



DA1146
3 watt LED exterior work light with smart matt black aluminium housing. Input voltage 10-30 volts. Waterproof to IP67 standards. 85mm diameter with mounting bracket. Incredibly bright and in most cases will not require a relay due to the 3 watt load.

Verdict
"Robust and gives a useful spread of light."
Neil Watterson, LRO Deputy Editor



DA4120
Hella Torero 5760 work light
Long-range illumination H3 work light with handle. Includes universal mount (swivel) with M10 mounting screw for upright or pendant mounting. Prism optics for long-range illumination. The housing is made of black plastic, with a prominent edge to protect the lens. The reflector of steel sheet is bonded to the glass lens. With switch, vibration damper and guard.

- > Rated voltage: 12/24 volts
- > Recommended inclination angle: 15° - 20°
- > Range: 40m
- > Light exit diameter: 120mm
- > Diameter: 152mm
- > Overall height: 239mm
- > Protection: IP5K4K
- > Suitable bulb: H3 (Halogen) not included

Part no. 12v - 606178

Inspection Lamps



DA5063 NEW
High Power Mechanics Headlamp
> 3W Cree LED provides 320 lumens of light output.
> Operating times: 2.5hrs (high); 8hrs (med) & 18hrs (low).
> Lamp adjusts through 50° to focus on work area.
> Tough & robust impact resistant aluminium construction, ideal for a workshop environment.
> Weatherproof design for outdoor use.
> Adjustable headstrap with padding for comfortable usage.
> 4 x AAA batteries included.



DA5064 NEW
MAGflex Ultra Bright LED Inspection Lamp
> Rechargeable and cordless.
> New technology strip LED provides 350 lumens light output while the torch provides 85 lumens.
> Multi-positioning for directional lighting.
> White light output simulates daylight.
> Optical lens provides wide angle uniform illumination.
> Magnet for hands free use.
> 2 x Integral hanging hooks.
> High power LED torch function.
> Anti slip comfortable grip.

- > Li-ion battery for faster consistent recharging.
- > Includes AC UK mains charger and 12v DC charging lead.
- > 3 hour operating time
- > 5 hour charging time.



DA5026
Professional LED Inspection Pocket Lamp
> Rechargeable and cordless for convenient use.
> High powered LEDs provides a bright light output.
> Anti-slip comfortable grip.
> Magnet for hands free use.
> LED torch function for focused light output.
> Precision reflector provides wide angle light output.
> Tough and robust polycarbonate lens for demanding conditions.
> Lithium ion battery for faster consistent recharging.
> Includes AC mains charging adapter with UK plug.

Specifications

Light Output	120 lumens
Battery	3.7v 1200mAh
Mains Adapter	Input 240v - 50/60Hz Output 5v - 300mA
Operating Time	5hrs
Charging Time	5hrs



DA5027
Essential LED Inspection Pocket Lamp
> Magnet for hands free use.
> LED torch function for focused light output.
> Protective lens for demanding conditions.
> Integral swivel pocket clip.
> Includes batteries.

Specifications

Battery	3 x AAA
Operating Time	5hrs



Photo courtesy of Thomas Bartlett





MONDAY	TUESDAY	WEDNESDAY	THURSDAY	FRIDAY	SATURDAY	SUNDAY
			1st	2nd	3rd	4th
5th	6th	7th	8th	9th	10th	11th
12th	13th	14th	15th	16th	17th	18th
19th	20th	21st	22nd	23rd	24th	25th
26th	27th	28th	29th	30th		

SEPTEMBER 2016

BRITPART
The quality parts for Land Rovers

Rajaz in Salt Planet

Iranian Modelled Land Rover
Khalil Sanjani, Star
by Hossein Farahani

Towing

This section contains all of the equipment needed to get you hitched up and towing with a wide selection of hitches and ancillary parts to suit all Land Rover models!

- All Models 54
- Defender 55
- Discovery 56 - 57
- Freelander 58
- Range Rover 59 - 60
- Series 58

Make Your Land Rover A Star!

Here at Britpart we are planning our next Land Rover themed calendar and we'd love to feature the pictures of proud Land Rover owner's vehicles – whatever model, age or condition of the vehicle.

We love to see pictures of Land Rovers in locations stretching from rural UK, right through to vehicles in a foreign urban environment - use your imagination. Winning entries will all feature in the next Britpart calendar and each one picked will win a great prize. So get out there with your Land Rover and camera - happy snapping. You can send us as many entries as you would like! **Good luck!**

Prizes

There will be 12 prizes awarded –

1 x first prize: £250 cash prize, 10 copies of the calendar with the winning image on the front cover and featured inside the calendar and a large Britpart hamper.

11 x second prizes: 5 copies of the calendar and a Britpart hamper.

Details on how to enter and full terms and conditions - www.britpart.com/calendar



All Models Towing Hitches



- 201691 Ball, jaw & pin - heavy-duty 4 bolt mounted (ball 3½ ton/jaw 5 ton)
- DA2123 Ball, jaw & pin (RTC8159/LR008244)
- DA5100 Tow hitch (3½ ton)
- KNB100640 Towing jaw (3½ ton)
- NRC2051 NATO Tow hitch



Ancillary Parts

- 67187 Pin universal coupling - heavy-duty (201691)
- DA2194 Replacement pin for DA2123
- ANR3635 50mm Tow ball cover
- 579408 7-pin trailer plug
- 7-pin to 13-pin adaptor
- DA5023 To use on vehicles with 7-pin towing electric sockets
- 13-pin to 2 x 7-pin adaptor - 12N/12S
- DA5025 Ideal for when vehicles with a 13-pin socket are required to tow caravan/trailer with twin 7-pin plugs.
- Universal towing electrics
- DA1126 12N Rear audible relay kit with pre-wired 2m cable
- DA2195 Replacement slider bracket - 1-pin
- DA2118 Replacement slider bracket - 2-pin
- RTC8831 Saddle slider - fits all Dixon Bates kits
- DA2123A Replacement chain, tag & clip
- DA2196 Replacement slider pin
- DA2197 Replacement slider pin 'R Clip'



- DA2605**
Autojaw Semi-automatic universal coupling
- > Self engaging / semi-automatic disengaging, simple one handed operation.
 - > No losable / stealable parts.
 - > Compact design for maximum ground clearance and minimum overhang.
 - > Minimum fixing point to towing point centre dimensions to minimise forces applied to both towbar and towing vehicle.
 - > No chains or wires.
 - > EC94/20 Approved (e11 005762).
 - > Compatible with 30, 40 & 50mm British standard eyes.
 - > Conforms to Road Traffic Act 1281 (1998).



Defender Towing Hitches



- DA2121 Defender 90/110 - up to WA
- DA2136 Defender 90 - WA onwards
- DA2137 Defender 110 - WA onwards
- LR007221 Defender 90 - Td5 & 2007 onwards
- LR007222 Defender 110 - Td5 & 2007 onwards
- LR007223 Defender 110/130 - 1998 onwards
- STC50269AA Defender 90 - XA onwards
- STC50301 Defender 110 - XA onwards
- VPLDT0086 Defender 110 - High-Cap pickup - 2007 onwards
- 242139 Defender 130 - Crew cab - 2007 onwards
- RTC8891AA Defender - all models



- Adjustable kit (RTC8828AA)
- Towbar assembly (VUB105460) - no electrics
- Towbar assembly (VUB105470) - no electrics
- Adjustable tow kit
- Adjustable tow kit
- High-Cap pickup adjustable tow kit (STC50257AB)
- Rear step - includes regulation tow bracket
- Rear step - includes regulation tow bracket
- Multi-height tow bar with tow ball
- Front towing eye
- 50mm Tow ball



- RTC8891AA



Ancillary Parts

- NRC8208 Defender - all models
- LR005919 Defender - 2007 onwards - all models
- LR005920 Defender - 2007 onwards - all models
- LR005921 Defender - 2007 onwards - all models
- STC4286 Defender - all models
- YWJ101500 Defender - Td5
- Bracket to rear cross member
- 13-pin socket electrics kit
- 'N' Type electrics kit
- 'S' Type electrics kit - front
- 12N 7-pin socket
- 'N' Type electrics plug



Britpart have all the equipment to get you hitched up and towing.

Discovery Towing Hitches



DA2134	Discovery 1 - up to 1994 Includes electrics (not plug-in) (STC8816)	Tow kit
DA2125	Discovery 1 - 1994 onwards (RTC8830, STC8060)	Adjustable coupling
RTC8891AA	Discovery 1	50mm Tow ball
DA2138	Discovery 2 Includes electrics (not plug-in), excludes tow ball	Towing kit
STC50287AB	Discovery 2 No electrics	Tow kit - coil suspension
STC50289AB	Discovery 2 No electrics	Tow kit - air suspension
STC50319	Discovery 2 None sliding adjuster - no electrics	Multi-height tow kit
KNB500070 / LR071295	Discovery 3 / Discovery 4 Quick disconnect without height adjustment Less Canada, Mexico & USA	Towing hook assembly
LR007484	Discovery 3 Less Canada, Mexico & USA	Adjustable tow hook kit
LR007484G	Discovery 3 Less Canada, Mexico & USA	Adjustable tow hook kit
LR041041	Discovery 4 Less Canada, Mexico & USA	Adjustable tow hook kit
LR041041G	Discovery 4 Less Canada, Mexico & USA	Adjustable tow hook kit
VPLCT0140LR	Discovery Sport 5-seat / 7-seat (less spare wheel)	Kit tow bar - flange ball
VPLCT0142LR	Discovery Sport 7-seat (with spare wheel)	Kit tow bar - flange ball
VPLCT0147 NEW	Discovery Sport 5-seat / 7-seat (less spare wheel)	Kit tow bar - quick release
VPLCT0148LR	Discovery Sport 7-seat (with spare wheel)	Kit tow bar - quick release
LR061295LR	Discovery Sport	Bumper cover



Discovery Ancillary Parts



STC4286	Discovery 1	12N 7-pin socket
STC8875	Discovery 1 - MA081881 onwards	12S socket
YWT10002L	Discovery 1	Electronic flasher unit for towing
STC50081	Discovery 2	'N' Type electrics socket
STC50181	Discovery 2	'N' Type electrics socket - less front fog lamps
STC50389	Discovery 2	Socket - split charge 'S' type post 1999 caravan
STC8919AA	Discovery 3	Tow strap
DA2602	Discovery 3	Tow bar electrics kit - 13-pin (YWJ500160)
YWJ500201	Discovery 3	Tow bar electrics kit 'N' & 'S' type For Great Britain & Ireland
VPLAT0011	Discovery 4	12N/12S 7-pin electric socket
VPLCT0185	Discovery Sport	Tow bar electrics - 13-pin 7-seats with spare wheel
VPLCT0182 NEW	Discovery Sport	Tow bar electrics - 13-pin 7-seats without spare wheel/5-seats

NEW Sign up to the regular Britpart newsletter to find out about all the latest product releases. www.britpart.com/newsletter



Freelander Towing Hitches



- KNK500060** Freelander 1 Tow bracket kit - European style fixed swan neck
- KNK500070** Freelander 1 Tow bracket kit - UK style 50mm ball fitted (VUB501490)
Note - This has a plug connection to the vehicle loom - with electrics
- STC50391** Freelander 1 Tow bracket kit
- KNK500080** Freelander 1 Tow bracket kit - swan neck detachable With plug-in electrics (KNK500080)
- VPLFT0120** Freelander 2 - DH000001 onwards Tow bracket kit - swan neck
- VPLFT0118** Freelander 2 Tow bracket kit
- VPLFT0119** Freelander 2 Excluding body styling kit Tow bracket kit - detachable ball tow bar

Ancillary Parts

- STC50459** Freelander 1 Electrical assembly kit 12S pre-1999 caravan auxiliary electrics
- STC50460** Freelander 1 Electrical assembly kit 12S post-1999 caravan auxiliary electrics
- YMZ101030** Freelander 1 Electrical assembly kit - 7-pin 12N lighting
- YWJ500070** Freelander 1 Electrical assembly kit 13-pin auxiliary electrics
- YWT10002L** Freelander 1 Electronic flasher unit for towing
- VPLFT0001** Freelander 2 - up to DH Electrical assembly kit 12N/12S 7-pin socket (LR003106)
- VPLFT0105** Freelander 2 - DH onwards Electrical assembly kit 12N/12S 7-pin socket
- VPLFT0077** Freelander 2 - CH000001 - CH999999 Electrical assembly kit - 13-pin socket
- VPLFT0106** Freelander 2 - DH onwards Electrical assembly kit - 13-pin socket

Series

Towing Hitches

- 242139** Series - all models Front towing eye
- DA2122** Series - all models Adjustable tow hitch kit
- RTC8891AA** Series - all models 50mm Tow ball
- DA2129** Lightweight Adjustable tow hitch kit



Ancillary Parts

- DA2012** Series - SWB Drop plate - standard
- DA2133** Series - all models Drop plate - extended

Range Rover Towing Hitches



- DA2125** Range Rover Classic Adjustable coupling (RTC8830/STC8060)
- DA2134** Range Rover Classic Tow kit (STC8816) up to 1994 Includes electrics but not plug-in electrics
- DA4030** Range Rover P38 Tow kit
Note - No tow ball included. It is not a Swan neck type, a standard 50mm tow ball is required (RTC8891AA). Electrics are included but not plug-in.
- KNB500070 / LR071295** Range Rover Sport - 2005 - 2013 Less Canada, Mexico, USA & Australia Towing hook assembly Quick disconnect without height adjustment
- LR007484** Range Rover Sport - 2005 - 2009 Less Canada, Mexico & USA Adjustable tow hook kit
- LR007484G** Range Rover Sport - 2005 - 2009 Less Canada, Mexico & USA Adjustable tow hook kit
- LR041041** Range Rover Sport - 2010 - 2013 Less Canada, Mexico & USA Adjustable tow hook kit
- LR041041G** Range Rover Sport - 2010 - 2013 Less Canada, Mexico & USA Adjustable tow hook kit
- VPLWT0159 NEW** Range Rover Sport - 2014 onwards Fixed multi-height tow bracket kit
- DA5030** Range Rover L322 Towbar/flange towball - equivalent to VUB000740 & VUB000720
Up to 2006 Europe model
Note - The tow bar armature accepts quick release, multi-height tow bars and bike carrier
- VUB000740** Range Rover L322 - inc. 2010 onwards Less Canada, Mexico & USA Multi-height tow bar Includes carry bag
- VUB000730** Range Rover L322 - inc. 2010 onwards Less Canada, Mexico & USA Quick release tow bar
- VUB503960** Range Rover L322 - inc. 2010 onwards Towing subframe - 6A000001 onwards Tow bar armature
- VPLGT0082** Range Rover L405 Tow kit bracket - fixed multi-height
- VPLVT0065** Range Rover Evoque Tow kit bracket - swan neck fixed
- VPLVT0069** Range Rover Evoque Tow kit bracket - quick release tow bar
- VPLVT0078** Range Rover Evoque Tow kit bracket - flange ball



Photo courtesy of Paul Coene



Range Rover Ancillary Parts



YWT10002L	Range Rover Classic - 1992 - 1994	Electronic flasher unit for towing
DA2602	Range Rover Sport - 2005 - 2009	Tow bar electrics kit 13-pin (YWJ500160)
YWJ500150	Range Rover Sport - 2005 - 2009 Less Canada, Mexico, USA	Tow bar electrics kit 12'N' & 12'S' type - 7-pin
VPLWT0114 NEW	Range Rover Sport - 2014 onwards	Tow bar electrics kit 13-pin
STC8919AA	Range Rover Sport - 2005 - 2013 & 2014 onwards	Tow strap
VUH000020	Range Rover L322 - up to 2006	Towing electrics with 13-pin socket, harness & control unit module (YWC000840)
YWC000840	Range Rover L322	Towing electrics control unit module
YWJ500450	Range Rover L322 - 6A000001 onwards Less Canada, Mexico & USA	Tow bar electrics kit 12'N' & 12'S' type - 7-pin
YWJ500460	Range Rover L322 - 6A000001 - up to 2009 Less Canada, Mexico & USA	Tow bar electric 13-pin socket & harness
STC8919AA	Range Rover L322	Tow strap
VPLGT0073	Range Rover L405 Less Canada, Mexico, USA & Australia	Tow bar electrics 13-pin socket & harness
VPLHT0061	Range Rover Evoque Less Canada, Mexico, USA & Australia	Tow bar electrics - 13-pin
VPLHT0062	Range Rover Evoque Canada, Mexico, USA	Tow bar electrics

Interior Protection

Protect the inside of your Land Rover with our selection of dog guards, load space mats, carpets and seat covers. Keep your vehicle looking smart inside no matter what you have to throw in it!

- Dog Guards** 62 - 63
- Loadspace**
 - Loadspace mats & protectors..... 63 - 65
 - Loadspace nets & retention kits..... 66
 - Loadspace protectors - premium..... 65
- Mats**
 - Carpet..... 67
 - Premium..... 67
 - Rubber..... 67 - 68
- Waterproof Seat Covers**
 - Britpart..... 69 - 70
 - Other..... 70



Photo courtesy of Louise Thompson

Dog Guards

DA4027 / RTC8095

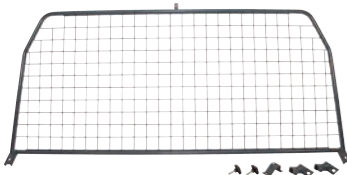

STC50479

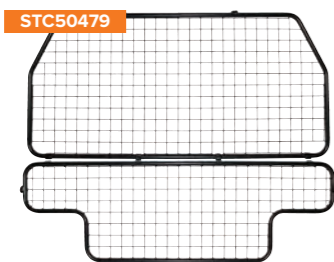

Defender/Series				
DA4027 / RTC8095	Defender 90/110 - 1987 - 2006 & 2007 onwards - hardtop with bulkhead	Half height	Mesh type	Grey
STC50479	Defender 90 - 1987 - 2006 - without bulkhead	Full height	Mesh type	Grey
STC7555	Defender 110 - County Station Wagon - 1987 - 2006	Full height - 1 piece	Mesh type	Grey
VUB500510	Defender 110 - Commercial with bulkhead removal bar fitted - 1987 - 2006	Full height - 2 piece	Mesh type	Black
DA5539	Defender 110 - County Station Wagon & Utility - 2007 onwards	Full height	Mesh type	Grey

STC7555



VUB500510

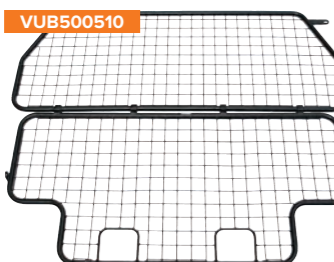

Discovery				
STC8414	Discovery 1	Half height	Mesh type	Grey
STC50323	Discovery 2	Half height	Mesh type	Grey
STC50082AA	Discovery 2	Half height	Bar type	Grey
DA5511A	Discovery 3/Discovery 4	Half height	Mesh type	Black
VUB501170	Discovery 3/Discovery 4	Full height	Mesh type	Black

Freelander				
STC7939AB	Freelander 1	Full height	Bar & mesh type	Grey
DA5801A	Freelander 2	Half height	Mesh type	Grey
LR002521	Freelander 2	Full height/full width	Mesh type	Black

STC8414

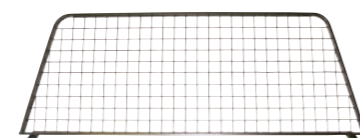

STC50323



DA5539



For more images - www.britpart.com/dog

STC50082AA

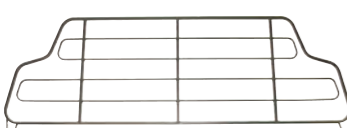

DA5511A

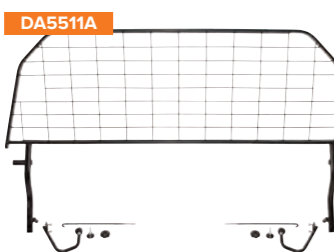

VUB501170

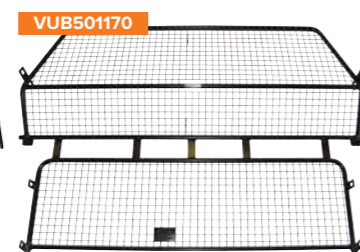

STC7939AB



DA5801A



LR002521

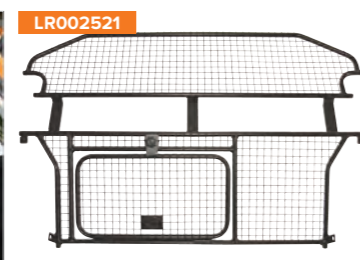
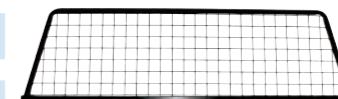

Photo courtesy of Richard Reid

Range Rover

DA4141	Range Rover Classic - 1986 - 1994	Half height	Mesh type	Black
STC8524	Range Rover P38	Half height	Bar type	Grey
DA1081	Range Rover Sport - 2005 - 2013	Half height	Mesh type	Grey
DA1082	Range Rover Sport - 2005 - 2013	Dog guard divider - use with DA1081	Mesh type	Grey
DA5810	Range Rover Sport - 2014 - onwards	Half height	Mesh type	Grey
DA5811	Range Rover Sport - 2014 - onwards	Dog guard divider - use with DA5810	Mesh type	Grey
VUB002120	Range Rover L322	Half height	Mesh type	Black
LR007320	Range Rover L322	Half height	Mesh type	Black
DA5806	Range Rover L405	Upper guard	Mesh type	Grey
DA5807	Range Rover L405	Lower guard	Mesh type	Grey
Can only be used in conjunction with DA5806				
DA5808	Range Rover L405	Dog guard divider - use with DA5806 & DA5807	Mesh type	Grey
DA5803	Range Rover Evoque - 5-door	Half height	Mesh type	Grey
DA5804	Range Rover Evoque - 5-door	Dog guard divider - use with DA5803	Mesh type	Grey
DA5805	Range Rover Evoque - 3-door	Half height	Mesh type	Grey

DA4141



STC8524



DA1081



DA1082



Keep Rover firmly in his place!



DA5810



DA5811



VUB002120 / LR007320



LR007320



DA5806



Upper guard only

DA5807



Lower guard only

DA5808



DA5803



DA5804



DA5805



Loadspace

Loadspace Mats & Protectors

STC50434



STC50435



LR002516



LR002424



Freelander			
STC50434	Freelander 1 - 3-door	Loadspace mat	Rubber
STC50435 NEW	Freelander 1 - 5-door	Loadspace mat	Rubber
LR002516	Freelander 2	Loadspace mat	Rubber
LR002424	Freelander 2	Loadspace protector	Semi-rigid with 3" deep sides
VPLFS0244	Freelander 2	Loadspace flexible protector	

Note - Not shown but is similar to image VPLSS0016 - see Range Rover Sport



Photo courtesy of Jo Pritchard



Photo courtesy of Ashley Lucas

Loadspace Mats & Protectors - continued



NEW Sign up to the regular Britpart newsletter to find out about all the latest product releases. www.britpart.com/newsletter

Defender/Series	Series	Loadspace mat	Dimensions	Material
331401	Series - SWB	Loadspace mat	1,177 x 920 x 3mm	Ribbed rubber
331670	Series - LWB	Loadspace mat	1,560 x 920 x 3mm	Ribbed rubber
MTC8294 NEW	Defender 90	Loadspace mat	1,250 x 920 x 3mm	Ribbed rubber
DA4470	Defender 90	Loadspace mat	1,230 x 920 x 6mm	Moulded rubber
LR005615	Defender 90	Loadspace mat	1,230 x 890 x 6mm	Moulded rubber
EAH500530 NEW	Defender 90 Station Wagon - 2007 onwards - 4-seat configuration	Loadspace mat	1,240 x 920 x 3mm	Ribbed rubber
331670	Defender - 110	Loadspace mat	1,560 x 920 x 3mm	Ribbed rubber
DA4503	Defender 110 - Hard top & truck cab	Loadspace mat	1,980 x 930 x 5mm with 6mm foam backing	Rubber
LR005613 NEW	Defender 110 - 2007 onwards - 5-seat configuration	Loadspace mat	1,230 x 890 x 6mm	Moulded rubber
LR005040 NEW	Defender 110 - 2007 onwards - 7-seat configuration	Loadspace mat	1,230 x 890 x 6mm	Moulded rubber
EAH500520 NEW	Defender 110 Station Wagon - 2007 onwards - 7-seat configuration	Loadspace mat	1,565 x 920 x 3mm	Ribbed rubber
EAH500540 NEW	Defender 110 Station Wagon - 2007 onwards - 5-seat configuration	Loadspace mat	1,565 x 920 x 3mm	Ribbed rubber

Keep dirt at bay with a loadspace liner...



Discovery	Series	Loadspace mat	Dimensions	Material
STC50052AA	Discovery 2	Loadspace mat - half length		Rubber
STC50053AA	Discovery 2	Loadspace mat - full length		Rubber
STC50050	Discovery 2	Loadspace protector		Semi-rigid with 8" deep sides
Note - Trim required for air-con models				
LR006401 NEW	Discovery 3/Discovery 4	Loadspace mat - half length		Rubber
EBF500010	Discovery 3/Discovery 4	Loadspace protector		Semi-rigid with 6" deep sides
VPLAS0015	Discovery 3/Discovery 4	Loadspace flexible protector		
Note - Not shown but is similar to Range Rover image - VPLSS0016				
VPLCS0279LR	Discovery Sport	Rubber mat - loading compartment		
VPLCS0273LR	Discovery Sport	Rubber mat - loading compartment	Extension	
VPLCS0268LR	Discovery Sport	Semi-rigid liner - loading compartment	Compatible with cargo barrier	
VPLCS0274LR	Discovery Sport	Semi-rigid liner - loading compartment	Not compatible with cargo barrier	

Loadspace Mats & Protectors - continued



Range Rover	Series	Loadspace mat	Material
VPLSS0043	Range Rover Sport - 2005 - 2013	Loadspace mat	Rubber
EBF500020	Range Rover Sport - 2005 - 2013	Loadspace protector	Semi-rigid with 4" deep sides
VPLSS0016	Range Rover Sport - 2005 - 2013	Loadspace flexible protector	
LR003894	Range Rover L322	Loadspace mat	Rubber
EBF000040	Range Rover L322	Loadspace protector	Semi-rigid with 6" deep sides
VPLGS0263	Range Rover L405	Loadspace protector	Semi-rigid with 2" deep sides
VPLVS0091	Range Rover Evoque	Loadspace mat	Rubber
VPLVS0089	Range Rover Evoque	Loadspace protector	Semi-rigid with 2" deep sides
VPLVS0090	Range Rover Evoque	Loadspace flexible protector	

Note - Not shown but is similar to Range Rover image - VPLSS0016



Loadspace Protectors - Premium



Premium semi-rigid loadspace protectors	Series	Dimensions
DA4183	Discovery 1	3" deep sides
DA4169	Discovery 2	3" deep sides
DA5602	Discovery 3/Discovery 4	3" deep sides
DA4171	Freelander 1	2" deep sides
DA5554	Freelander 2	2" deep sides
DA4170	Range Rover P38	3" deep sides
DA5555	Range Rover Sport - 2005 - 2013	2" deep sides
DA5556	Range Rover L322 - all models	2" deep sides

Britpart's unique premium loadspace mats are manufactured from a high-specification material. Designed to be durable with an anti-slip, matt look finish. These quality protector will look after your Land Rover's loadspace for years to come.

Premium loadspace protectors manufactured from semi-rigid foam with anti-slip finish and 2" deep sides.	Series
DA4829 NEW	Discovery Sport
DA5557	Range Rover Evoque - 3 & 5 door models
DA4825	Range Rover Sport - 2014 onwards
DA4822	Range Rover L405

Loadspace Nets & Retention Kits



Loadspace Retention Kits
Restricts the movement of goods in the rear of the vehicle.
VUB000700
Range Rover L322
Contents - 1 x floor net & 2 x ratchet straps
VPLCS0269 NEW
Discovery 3/Discovery 4/Discovery Sport
Range Rover Sport - 2005 - 2013/Range Rover Evoque
Contents - 1 x floor net & 2 x ratchet straps
VPLVS0125
Range Rover Sport - 2010 - 2013/Range Rover Evoque
Contents - 1 x rear retention bars; 1 x side retention strap & 1 x storage case
Note - must be used in conjunction with loadspace luggage rails.

Loadspace Luggage Rails
VPLSS0138
Range Rover Sport - 2010 - 2013
VPLVS0102
Range Rover Evoque



Loadspace Nets
A convenient way of storing luggage.
LR017770 Range Rover L322 Contents - 2 x nets
VPLCS0271 Freelander 2/Discovery Sport
NEW Range Rover Evoque Contents - 1 x net
Can be used in two positions within the loadspace

Umbrella Holder
A convenient way of storing your umbrella
VPLGS0153 Range Rover L405 Contents - 2 x holders

Ratchet Straps
Make sure your load is safely secured.
DA1267 NEW
2m - pair



Mats



Carpet Mat Sets



DA4022BLACK Defender - all models - front only Black
DA4023BLACK Discovery 1 Black
DA4023BLUE Discovery 1 Blue
DA4023GREY Discovery 1 Grey
Note - Front and rear carpet sets with rubber backing.

Rubber Mat Sets



Heavy-duty Defender rubber mats with foam backing

Individual Mats	Model	Location
BTR7895	Defender - LT77 gearbox	Front floor left hand
BTR7896	Defender - LT77 gearbox	Front floor right hand
BTR7897	Defender - 1993 onwards	Front floor left hand
BTR7898	Defender - 1993 onwards	Front floor right hand

Mat Sets

Mat Sets	Model	Location	Notes
DA4501	Defender - LT77 gearbox	Front right & left hand	Contains - BTR7895 & BTR7896
DA4502	Defender - 1993 onwards	Front right & left hand	Contains - BTR7897 & BTR7898
STC50172	Defender - from XA159807	Front right & left hand	No foam backing
LR005039	Defender - up to BA999999	Front right & left hand	No foam backing
VPLDS0147	Defender - from CA000001	Front right & left hand	No foam backing

Premium Mat Sets



Carpet mats with rubber backing

Part Number	Model	Location	Hand	Color
VPLFS0245PVJ	Freelander 2	Front & rear contour set	RHD	Ebony black
VPLFS0246PVJ	Freelander 2	Front & rear contour set	LHD	Ebony black
LR002485	Freelander 2	Front & rear contour set	RHD	Alpaca beige
LR002497	Freelander 2	Front & rear contour set	LHD	Alpaca beige
EAH500080PVJ	Discovery 3	Front & rear floor set	LHD	Ebony black
LR006433	Discovery 3	Front & rear contour set	LHD	Alpaca beige
VPLAS0023PVJ	Discovery 3/Discovery 4	Front & rear contour set	LHD	Ebony black
EAH500011LUP	Range Rover Sport - 2005 - 2013	Front & rear floor set	LHD	Aspen
LR006437	Range Rover Sport - 2008 - 2013	Front & rear contour set	LHD	Ebony black
EAH500011PVJ	Range Rover Sport - 2005 - 2013	Front & rear floor set	LHD	Ebony black
EAH500015SMS	Range Rover Sport - 2005 - 2013	Front & rear floor set	LHD	Alpaca beige
EAH000300JMN	Range Rover L322 - up to 6A	Front & rear contour set	RHD	Navy
EAH000310JMN	Range Rover L322 - up to 6A	Front & rear contour set	LHD	Navy
EAH000310LUP	Range Rover L322 - up to 6A	Front & rear contour set	LHD	Aspen
EAH000300PVA	Range Rover L322 - up to 6A	Front & rear contour set	RHD	Jet
EAH000300SUN	Range Rover L322 - up to 6A	Front & rear contour set	RHD	Sand
EAH000310SUN	Range Rover L322 - up to 6A	Front & rear contour set	LHD	Sand
EAH500290LUP	Range Rover L322 - from 7A	Front & rear contour set	LHD	Aspen
EAH500290PVA	Range Rover L322 - from 7A	Front & rear contour set	LHD	Jet
EAH500290SUN	Range Rover L322 - from 7A	Front & rear contour set	LHD	Sand

Premium protection for your Land Rover...

Rubber mats

Part Number	Model	Location	Hand	Color
VPLFS0233	Freelander 2	Front & rear contour set	RHD	Black
VPLFS0234	Freelander 2	Front & rear contour set	LHD	Black
LR006237	Discovery 3/Discovery 4	Front & rear contour set	RHD	Black
LR006238	Discovery 3/Discovery 4	Front & rear contour set	LHD	Black
EAH500100PMA	Discovery 3/Discovery 4	3rd row floor mat	N/A	Black
EAH500052PMA	Discovery 3	Front & rear floor set	RHD	Black
EAH500050PMA	Discovery 3	Front & rear floor set	LHD	Black
EAH500058PMA	Discovery 3	Front contour set	RHD	Black
EAH500057PMA	Discovery 3	Front contour set	LHD	Black
VPLCS0278LR	Discovery Sport	1st & 2nd row	RHD	Black
VPLCS0281LR	Discovery Sport	1st & 2nd row	LHD	Black
VPLCS0280LR	Discovery Sport	3rd row floor mat	N/A	Black
VPLAS0197	Range Rover Sport - 2005 - 2013	Front & rear contour set	RHD	Black
VPLAS0198	Range Rover Sport - 2005 - 2013	Front & rear contour set	LHD	Black
VPLSS0104	Range Rover Sport - 2005 - 2013	Front & rear floor set	RHD	Black
EAH500051PMA	Range Rover Sport - 2005 - 2013	Front & rear floor set	LHD	Black
EAH500320PMA	Range Rover L322	Front & rear contour set	RHD	Black
EAH500330PMA	Range Rover L322	Front & rear contour set	LHD	Black
EAH000261PMA	Range Rover L322	Front & rear floor set	RHD	Black
EAH000271PMA	Range Rover L322	Front & rear floor set	LHD	Black
LR045096	Range Rover Evoque	Front & rear contour set	RHD	Black
LR045097	Range Rover Evoque	Front & rear contour set	LHD	Black



Photo courtesy of Jundio Salvador

Rubber Mats



Quality fitted rubber over mats			
DA4422	Series 2/Series 3	Front	Pair
DA4423	Defender - all models from XA159807	Front	Pair
LR005041	Defender - 110 - 2007 onwards - crew cab pick up	2nd row	NEW Single
DA4426	Discovery 1	Front	Pair
DA4427	Discovery 1	Rear	Pair
DA4424	Discovery 2	Front	Pair
DA4425	Discovery 2	Rear	Pair
DA4802	Discovery 3/Discovery 4	RHD Front & Rear	Set
DA4803	Discovery 3/Discovery 4	LHD Front & Rear	Set
DA4819	Discovery 3/Discovery 4	3rd row contour floor mat	NEW
DA4827	Discovery Sport	RHD Front & Rear	Set
DA4828	Discovery Sport	LHD Front & Rear	Set
DA4832	Discovery Sport	3rd row contour floor mat	NEW
DA4428	Freelander 1	Front	Pair
DA4429	Freelander 1	Rear	Pair
DA4800	Freelander 2	RHD Front & Rear	Set
DA4801	Freelander 2	LHD Front & Rear	Set
DA4430	Range Rover P38	Front	Pair
DA4431	Range Rover P38	Rear	Pair
DA4804	Range Rover Sport - 2005 - 2013	RHD Front & Rear	Set
DA4805	Range Rover Sport - 2005 - 2013	LHD Front & Rear	Set
DA4823	Range Rover Sport - 2014 onwards	RHD Front & Rear	Set
DA4824	Range Rover Sport - 2014 onwards	LHD Front & Rear	Set
DA4806	Range Rover L322 - up to 6A999999	RHD Front & Rear	Set
DA4807	Range Rover L322 - up to 6A999999	LHD Front & Rear	Set
DA4808	Range Rover L322 - 7A000001 onwards	RHD Front & Rear	Set
DA4809	Range Rover L322 - 7A000001 onwards	LHD Front & Rear	Set
DA4820	Range Rover L405 - 2013 onwards	RHD Front & Rear	Set
DA4821	Range Rover L405 - 2013 onwards	LHD Front & Rear	Set
DA4812	Range Rover Evoque - 2 & 4 door	RHD Front & Rear	Set
DA4813	Range Rover Evoque - 2 & 4 door	LHD Front & Rear	Set

For more mat images - www.britpart.com/mats



Keep your Land Rover interior clean with a set of Britpart fitted rubber mats.

Waterproof Seat Covers

Britpart Seat Covers

Colour swatches for illustrative purposes only.



Model	BLACK	BLUE	GREEN	GREY	SAND
Defender Defender - up to 2007 - 3 Seats - Front Covers in kit - 3 x full seat (excludes headrest covers)	DA2815BLACK	DA2815BLUE	DA2815GREEN	DA2815GREY	DA2815SAND
Defender - 2007 onwards - Front Covers in kit - 2 x full seat; 2 x headrest	DA2818BLACK			DA2818GREY	DA2818SAND
Defender 110 Station Wagon - up to 2007 - Forward facing 2nd row - 60/40 Covers in kit - 1 x two-seat back & base; 1 x one-seat back & base. Note - Will fit 110 Crew Cab with minor modification to seat covers.	DA2816BLACK	DA2816BLUE		DA2816GREY	
Defender 110 Station Wagon - up to 2007 - Rear inward facing bench Covers in kit - 2 x bench-seat back & base. Note - For 1,200mm long seat.		DA2817BLUE		DA2817GREY	
Defender 90/110 - 2007 onwards - Rear 2nd row forward facing Covers in kit - 2 x full seat; 2 x headrest	DA2838BLACK				
Defender 110/130 - 2007 onwards - Rear 2nd row forward facing - 60/40 split Covers in kit - 3 x full seat; 3 x headrest	DA2828BLACK				
Discovery Discovery 1 - Front Covers in kit - 2 x full seat. Note - Discovery 1 seat covers will not fit vehicles with leather seats and 200Tdi's with pocket on rear seat.	DA2807BLACK	DA2807BLUE	DA2807GREEN	DA2807GREY	DA2807SAND
Discovery 1 - Rear Covers in kit - 1 x two-seat back & base; 1 x one-seat back & base. Note - Discovery 1 seat covers will not fit vehicles with leather seats and 200Tdi's with pocket on rear seat.	DA2808BLACK	DA2808BLUE	DA2808GREEN	DA2808GREY	DA2808SAND
Discovery 1 - Boot Covers in kit - 2 x full seat. Note - Discovery 1 seat covers will not fit vehicles with leather seats and 200Tdi's with pocket on rear seat.		DA2809BLUE	DA2809GREEN	DA2809GREY	
Discovery 2 - Front Covers in kit - 2 x full seat; 2 x headrest; 2 x armrest.	DA2800BLACK	DA2800BLUE	DA2800GREEN	DA2800GREY	DA2800SAND
Discovery 2 - Rear Covers in kit - 1 x full seat; 1 x two-seat back & base; 1 x armrest; 3 x headrest	DA2801BLACK	DA2801BLUE	DA2801GREEN	DA2801GREY	DA2801SAND
Discovery 2 - Boot Covers in kit - 2 x full seat; 2 x roof headrest.			DA2802GREEN	DA2802GREY	
Discovery 3 - Front Covers in kit - 2 x full seat; 2 x headrest; 2 x armrest. Note - Suitable for vehicles with side airbags.	DA2822BLACK				DA2822SAND
Discovery 3 - Rear - 35/30/35 split Covers in kit - 3 x full seat; 3 x headrests.	DA2823BLACK				DA2823SAND
Discovery 4 - Front Covers in kit - 2 x full seat; 2 x headrest; 2 x armrest. Note - Suitable for vehicles with side airbags.	DA2832BLACK				



A fantastic way to protect your Land Rover seats with these Britpart waterproof covers.

- > An extensive range of quality and stylish waterproof seat cover sets.
- > Front and rear sets available with headrests and armrests included in the Range Rover and Freelander range.
- > Rear inward facing sets are also available for the 7-seater Discovery models.
- > The hard-wearing washable covers are made from waterproof woven polyester with a PVC backing.
- > Snug fit covers available in stylish colours.
- > Easy to put on the seats and just as easy to remove again.

Britpart Seat Covers - continued

Colour swatches for illustrative purposes only.



Model	BLACK	BLUE	GREEN	GREY	SAND
Freelander					
Freelander 1 - 3 Door - Front	DA2810BLACK			DA2810GREY	
Covers in kit - 2 x back, base & headrest. Note - Not suitable for 2004 onwards facelift models.					
Freelander 1 - 5 Door - Front	DA2811BLACK			DA2811GREY	
Covers in kit - 2 x back, base & headrest. Note - Not suitable for 2004 onwards facelift models.					
Freelander 1 - 3 & 5 Door - Rear 60/40 split without armrest	DA2813BLACK	DA2813GREEN		DA2813GREY	
Covers in kit - 1 x two-seat back & base; 1 x one-seat back & base; 3 x headrest. Note - Not suitable for 2004 onwards facelift models.					
Freelander 1 - 3 & 5 Door - Rear 60/40 split with armrest	DA2814BLUE			DA2814GREY	
Covers in kit - 1 x two-seat back & base; 1 x one-seat back & base; 3 x headrest. Note - Not suitable for 2004 onwards facelift models.					
Freelander 1 - 3 Door Sport - 2 Rear Seats	DA2812BLUE	DA2812GREEN		DA2812GREY	
Covers in kit - 2 x back, base & headrest. Note - Not suitable for 2004 onwards facelift models.					
Freelander 2 - Front	DA2821BLACK				
Covers in kit - 2 x full seat; 2 x headrest; 2 x armrest. Note - Suitable for use with airbags.					
Freelander 2 - Rear	DA2831BLACK				
Covers in kit - 1 x two-seat back & base; 1 x one-seat back & base; 3 x headrest & 3 x armrest. Note - Not suitable for vehicles with leather seats.					
Range Rover					
Range Rover Classic - 4 Door - Front	DA2803BLACK	DA2803BLUE		DA2803GREY	DA2803SAND
Covers in kit - 2 x back, base, armrest & headrest.					
Range Rover Classic - 4 Door - Rear	DA2804BLUE	DA2804GREEN		DA2804GREY	DA2804SAND
Covers in kit - 1 x two-seat back & base; 1 x one-seat back & base; 3 x armrest.					
Range Rover P38 - Front		DA2805GREEN	DA2805GREY		
Covers in kit - 2 x full seat, headrest & armrest. Note - Not suitable for vehicles with rear air bags mounted in the front seats or seats with electric headrests.					
Range Rover Sport - 2005 - 2009 - Front	DA2819BLACK				DA2819SAND
Covers in kit - 2 x full seat; 2 x headrest; 2 x armrest.					
Range Rover Sport - 2005 - 2009 - Front - vehicles with electric headrests					DA2825SAND
Covers in kit - 2 x full seat; 2 x headrest; 2 x armrest.					
Range Rover Sport - 2005 - 2009 - Rear	DA2829BLACK				
Covers in kit - 1 x two-seat back & base; 3 x headrest & 3 x armrest					
Range Rover Sport - 2010 - 2013 - Front	DA2839BLACK				DA2839SAND
Covers in kit - 2 x full seat, headrest & armrest					
Range Rover L322 - 2007 - 2009 - Front	DA2820BLACK				
Covers in kit - 2 x full seat; 2 x headrest; 2 x armrest. Note - Non-power assisted headrests only.					
Range Rover L322 - Rear	DA2830BLACK				
Covers in kit - 1 x one-seat base; 1 x two-seat base; 2 x back; 1 x middle back; 2 x headrest					



Plenty more images available to view at www.britpart.com/seatcovers



Seats & Trim

Are your Land Rovers seats looking old and saggy? Our extensive range of seats and re-trim kits will smarten up your vehicle. Fitting a Britpart cubby box in your Land Rover will help keep your vehicle clutter free!

- Bulkhead Bars.....73
- Cubby Boxes & Armrests
 - Defender & Series.....72
 - Discovery Sport.....73
 - Freelander.....72
 - Range Rover Evoque.....73
- Door Stays.....80
- Extended Slide Seat Rails.....73
- Gear Box Gaiters.....74
- Glove Boxes.....73
- Hoods
 - Fume curtain.....75
 - Hoods.....75
 - Hood stick kits.....75
- Retrofit Seat Heaters.....77
- Seat Belts.....74
- Seat Belt Stress Plate.....74
- Seats
 - Corbeau seats.....79
 - Defender - front seats.....76
 - Defender & Series - rear seats.....77
 - Re-trim kits.....78
 - Series - front seats.....77
 - Sparco seats.....79
 - Trade tack stab.....78
 - XS style seats.....78
- Trim
 - Chain cover.....80
 - Dash trim kits.....80
 - Door trims.....80
 - Seat handle & cover kit.....80

Waterproof Seat Covers - Other

Inka Seat Covers			
These stylish seat cover kits also include headrest and armrest covers (where applicable) with a fitting guide. The kits are waterproof, fire retardant and washable.			
VPLDS0011	Defender - 2007 onwards	Front	Black
VPLAS0130PVJ	Discovery 4	Front	Black
VPLFS0107PVJ	Freelander 2	Front	Black
LR005059	Freelander 2	Front	Sand
LR005058	Freelander 2	Front	Aspen
VPLSS0026PVJ	Range Rover Sport - 2010 - 2013	Front	Black
Range Rover Evoque			
VPLVS0070PVJ	3-door less rear entertainment	Front	Black
VPLVS0071PVJ	5-door less rear entertainment	Front	Black
VPLVS0072PVJ	2 individual 2nd row seat	Rear	Black
VPLVS0073PVJ	2nd row 60/40 folding with armrests	Rear	Black
VPLVS0077PVJ	2nd row 60/40 folding	Rear	Black
Range Rover L405			
VPLGS0154SVA		Front	Almond
VPLGS0154PVJ		Front	Black
VPLGS0155SVA	60/40 power fold	Rear	Almond
VPLGS0155PVJ	60/40 power fold	Rear	Black
Range Rover L322 - 2010 - 2012			
VPLMS0085SVA		Front	Sand
VPLMS0085PVJ		Front	Black
VPLMS0087SVA		Rear	Sand
VPLMS0087PVJ		Rear	Black

Land Rover Seat Covers			
Discovery Sport			
VPLCS0291PVJLR	Front	Black	
VPLCS0292PVJLR	2nd row	Black	
VPLCS0293PVJLR	3rd row	Black	
VPLCS0291SVALR	Front	Almond	
VPLCS0292SVALR	2nd row	Almond	
VPLCS0293SVALR	3rd row	Almond	
Range Rover L322 - 2002 - 2006			
HBD000320JMN	Front	Navy	
HBD000320LUP	Front	Aspen	
HBD000320LYR	Front	Charcoal	
HBD000320SUN	Front	Sand	
Range Rover Sport - 2014 onwards			
VPLWS0228PVJ NEW	Front	Black	
VPLWS0229PVJ NEW	Rear - 60/40 split	Black	
VPLWS0230PVJ NEW	Rear - 60/40 manual fold	Black	
VPLWS0228SVA NEW	Front	Almond	
VPLWS0229SVA NEW	Front	Almond	
VPLWS0230SVA NEW	Front	Almond	



Cubby Boxes & Armrests

Defender & Series

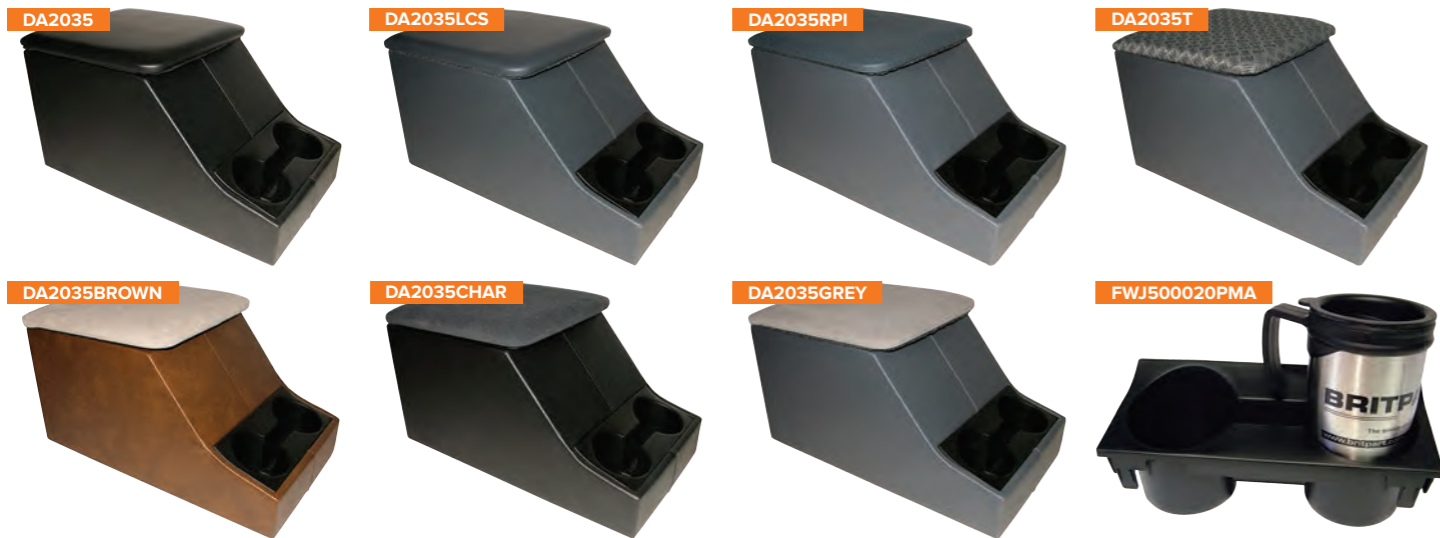

Fitting a Britpart cubby box in your Land Rover will help you keep your vehicle clutter free. With a double cup holder as standard, spill drinks are a thing of the past.

Hand-built in the UK, these quality cubby boxes are suitable for Series 3 and Defenders. Well crafted with precision tools using a hard wearing leatherette outer with locking stay brass hinges.

	Top	Body
DA2035	Black	Black
DA2035LCS	Grey	Grey
DA2035RPI	Vinyl twill	Grey
DA2035T	Techno	Grey
XS Style		
DA2035BROWN	Light brown	Dark brown
DA2035CHAR	Charcoal	Black
DA2035GREY	Light grey	Dark grey



Cubby Box Cup Holder FWJ500020PMA
Double cup holder for both old and new model Defenders - ideal for holding a Britpart travel mug or two!!
Note - Will fit Defenders up to 2007. To fit to existing carpet lined cubby box the lining may have to be taken out. Excludes travel mug - DA8015.

Security Cubby Box DA2149
If security is a worry, then peace of mind can be achieved with this secure powder coated steel cubby box with padded lid. Includes a lockable slot for radios and CB units. 2 keys & 3 removable cup holders.

Freelander



Freelander 1 - 2001 - 2006
Add some support to your Freelander with one of these stylish adjustable armrests.
> Innovative design.
> Easy do-it-yourself installation.
Dimensions - 290mm long x 170mm wide x 130mm high.

DA5116	Black eco leather
DA5117	Black real leather
DA5118	Smokestone real leather

Freelander 2 - up to 2012 - with no factory fitted armrests
Add some extra storage space in your Freelander 2 with one of these stylish cubby boxes.
> Innovative design.
> Strong ABS storage base.
> Large storage capacity.
> Easy do-it-yourself installation in only 5 minutes in the original point.
> Boxes have adjustable sliding tops.
Dimensions - 230mm long x 145mm wide x 180mm high.

DA5116	RHD	Black real leather
DA5117	RHD	Black eco leather
DA5118	RHD	Alpaca leather
DA5119	RHD	Almond leather
DA5120	LHD	Black real leather
DA5121	LHD	Black eco leather
DA5122	LHD	Alpaca leather
DA5123	LHD	Almond leather

Freelander 2 - up to 2012 - with factory fitted armrests
Dimensions - 220mm long x 125mm wide x 160mm high.

DA5115	RHD & LHD	Black real leather
DA5116	RHD & LHD	Black eco leather
DA5117	RHD & LHD	Alpaca leather
DA5118	RHD & LHD	Almond leather

Freelander 2 - 2013 onwards - without original armrest in the seat
> Armrest with soft pad and real stitching.
> Simple do-it-yourself fitting in only 5 minutes.
Dimensions - 280mm long x 200mm wide x 220mm high.

DA5138	RHD & LHD	Black eco leather
DA5139	RHD & LHD	Black automotive fabric
DA5140	RHD & LHD	Black real leather
DA5141	RHD & LHD	Almond real leather



For more images - www.britpart.com/cubby

Discovery Sport NEW



Specific armrest with soft pad and real stitching for Discovery Sport models without one fitted originally. The armrest is made and designed using only quality materials to guarantee comfort and longevity. Handmade in Italy.
> Innovative design.
> Fits right and left hand drive vehicles.
> Flips up and out of the way.
> Soft pad.
> Invisible fitting system - no screws or brackets in sight.
> Do-it-yourself fitting in only 5 min.
DA5142 NEW Black eco leather
DA5143 NEW Black automotive fabric



Range Rover Evoque



Improve your driving position in a Range Rover Evoque with an additional armrest.
> Manufactured from real leather and simple to fit.
> The armrest can easily be moved to suit your driving position and you will still be able to access the cubby box.
Evoque with non-adjustable armrests
DA5122 Black
DA5123 Lunar
DA5124 Almond
Evoque with adjustable armrests
DA5146 NEW Black
DA5147 NEW Lunar
DA5148 NEW Almond



Bulkhead Bars



DA1810 Defender OEM bulkhead removal bar kit
DA2351 Defender bulkhead reduction bar kit
Need more leg room and seat adjustment in your Defender?
These bulk head bars alleviate that problem without compromising strength. The bulk head bars allow for extra seat recline and travel on the seat base - giving you a more comfortable seating position and more space in the front foot wells. The bars create a rigid bracing for the front of the Defender tub as well as the added benefits of extra room in the vehicle due to the seats being more manoeuvrable, access to the rear of the Defender is now not compromised by a higher bulk head. Powder coated and supplied complete with all the necessary fixings and instructions.



Extended Seat Rails



> Ideal for the taller driver.
> A more practical and comfortable driving position.
DA2148
Give your Defender (including 2007 onwards model) seats 3" of extra slide with a pair of these seat rails. Ideal for the taller driver to give a more practical and comfortable driving position. One pair of rails is suitable for one seat.



Photo courtesy of James Profit

Glove Boxes



Neat storage solution for the Defender - 2007 onwards model - which utilises the available dashboard space. Ideal for storing all the usual small items you carry with you. Robust construction and easy to fit with all the necessary parts supplied. Suitable for both right and left hand drive vehicles.
DA2603 Normal interior finish fascia plate
DA2603CF Carbon fibre effect finish fascia plate

Gear Box Gaiters



Got a Land Rover with a tatty gear box gaiter? Why not replace it with a smart new one?

- DA5498 Defender Grey
 - DA5499 Defender Black
 - DA5497 NEW Defender - 2007 onwards Black
 - DA2466 Series Black
- Kit contents - handbrake, gearstick and 4-wheel drive selector.



- Discovery 1 & Discovery 2**
- FJL101680PMA Gear lever Black
 - FJL101710PMA Handbrake lever Black
 - FJL101530PMA High/low lever Black
 - DA5496 NEW Re-trim kit Black
- Kit contents - gaiters for gear lever, handbrake lever & high/low lever.

Seat Belts NEW

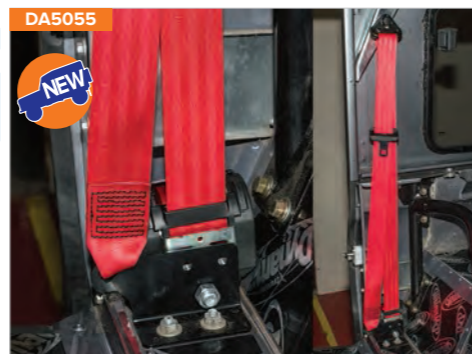

Add a splash of colour to your Defender's interior by fitting a set of these red seat belts. Type approved.

- DA5055 NEW Defender - truck cab RHS
- DA5056 NEW Defender - truck cab LHS
- DA5057 NEW Defender - station wagon Single



facebook.com/britpart

Seat Belt Stress Plate



DA3502 NEW
FIA specification stress plate with 65mm square backing plate and 7/8" captive nut.

Hoods

Fume Curtain



MRC3519 Defender/Series
Note - Hood stick not included - 330553

Hoods

Got a Land Rover with a hood that has seen better days?

Tears? Frayed fixings? Scratched windows?

We'll give your vehicle a quick facelift with a new canvas hood from Britpart.



Hood Stick Kits NEW



330999 NEW Series 2, 2A & 3 SWB
332951 NEW Series 2, 2A & 3 LWB

33110AG	Series - SWB	Full hood Khaki	Without windows
33113AG	Series - SWB	Full hood Khaki	With windows
33110SA	Series - SWB	Full hood Sand	Without windows
33113SA	Series - SWB	Full hood Sand	With windows
331371AG	Series - SWB	Three quarters hood Khaki	Without windows
331259AG	Series - LWB	Full hood Khaki	Without windows
331260AG	Series - LWB	Full hood Khaki	With windows
331259SA	Series - LWB	Full hood Sand	Without windows
331260SA	Series - LWB	Full hood Sand	With windows
MUC2437	Series - LWB - V8	High capacity pick-up 3/4hood	Without windows
MUC4122ABE	Defender 90	Full hood Sand	With windows
MUC7916AG NEW	Defender 110	3/4 hood Khaki	With windows



- > Hoods are made from the original 18oz canvas and made to OEM specifications.
- > All fittings are brass and made to OEM specifications.
- > Webbing is made the same way as the original.
- > Polypropylene rope is the same construction as the original rope.
- > Ropes are all inserted into the hood to help customers.
- > Care instruction are included.

Other hoods available on request - please ask for details.



Photo courtesy of Tim Brown



Photo courtesy of Alan Twigg

Seats

Defender - Front Seats

Black Seats		
DA4028	Seat cover	Outer base
DA4041	Seat cover	Outer back
DA4589	Seat cover	Centre base - 1990 onwards
DA4590	Seat cover	Centre back - 1990 onwards
MWC3302	Seat	Right hand back
MWC3303	Seat	Left hand back
MWC4535	Seat	Outer base
MWC1010	Headrest assembly	

Grey Seats		
DA4029	Seat cover	Outer base
DA4042	Seat cover	Outer back
DA4591	Seat cover	Centre base - 1990 onwards
DA4592	Seat cover	Centre back - 1990 onwards
BTR1759LCS	Seat cover with map pocket	Outer back
MWC9844LCS	Seat	Right hand back
MWC9843LCS	Seat	Left hand back
MWC5670LCS	Seat	Outer base
MWC5628LCS	Headrest assembly	
MXC3257LCS NEW	Left hand assembly	Less headrest

All products leaving the Trim Shop are produced to the highest standards.

Vinyl Twill Seats		
AWR5701RPI	Seat cover	Outer base
AWR5702RPI	Seat cover	Outer back
DA4593	Seat cover	Centre base - 1990 onwards
DA4594	Seat cover	Centre back - 1990 onwards
AWR5698RPI	Seat	Right hand back
AWR5699RPI	Seat	Left hand back
AWR5700RPI	Seat	Outer base
AWR5708RPI	Headrest assembly	
HAD501820RPI	Right hand assembly	Less headrest
HAD501870RPI	Left hand assembly	Less headrest

Techno Style Seats		
HAD501870LOY NEW	Seat assembly with map pocket	Right hand side
HAD501850LOY NEW	Seat assembly with map pocket	Left hand side
HAG100970LOY	Base	
HCA106010LOY	Cover base	
DA4595	Seat cover	Centre base - 1990 onwards
DA4596	Seat cover	Centre back - 1990 onwards
HJA101400LOY	Squab assembly - no pockets	Right hand side
HJA101410LOY	Squab assembly - no pockets	Left hand side
HBA106190LOY	Squab cover - no pocket	
HBA106180LOY	Squab cover - with pocket	
HAH103510LOY	Headrest	

Foam, Runners & Finishers		
349943	Plastic corner capping for standard Defender & Series seat bases	
DA4031	Seat foam	Outer base
DA4055	Seat foam	Outer back
DA4057	Seat foam	Centre base
DA4056	Seat foam	Centre back
MTC9967	Front seat edge finisher	
HHD102280	Runner & sub-frame	Right hand side
HHD102290	Runner & sub-frame	Left hand side



The highly skilled team in the Britpart Trim Shop make a wide range of seats and seat covers for Land Rover vehicles by hand. The material arrives in vast reams and has to be cut with great precision before being stitched together and then assembled into seat bases, seat backs, seat benches etc. In keeping with the Britpart philosophy, all products leaving the Trim Shop are produced to the highest standards and meet with the strictest safety regulations.

For many more pictures of our seats and trim - www.britpart.com/seats



Series - Front Seats

Black Seats		
349967	Seat base	Standard outer
320699	Seat base - adjustable	Standard outer
320726	Seat base	Standard centre
320698	Seat back - bolt fitment - adjustable	Standard outer
MUC1520	Seat back - pin fitment	Standard outer
MUC1520G	Seat back - bolt fitment	Standard outer
MUC1488	Seat back	Standard centre
DA4305	Standard seat kit	

Note - Kit contains - 2 x 349967; 2 x MUC1520; 1 x 320726 & 1 x MUC1488		
MRC6980	Seat base	Deluxe outer
MRC6982	Seat back	Deluxe outer
MRC6982H	Seat back with headrest	Deluxe outer
MRC6985	Seat base	Deluxe centre
MTC3181	Seat back	Deluxe centre
DA4298	Seat back	Deluxe seat kit

Note - Kit contains - 2 x MRC6982; 2 x MRC6980; 1 x MTC3181 & 1 x MRC6985		
County Brown Seats		
MRC6980CB	Seat base	Deluxe outer
MRC6982CB	Seat back	Deluxe outer
MRC6985CB	Seat base	Deluxe centre
MTC3181CB	Seat back	Deluxe centre

County Grey Seats		
MRC6980CG	Seat base	Deluxe outer
MRC6982CG	Seat back	Deluxe outer
MRC6985CG	Seat base	Deluxe centre
MTC3181CG	Seat back	Deluxe centre



Retrofit Seat Heaters

DA5717
Enjoy comfortable seat heating in a matter of seconds with these retrofit insert seat heaters. Highly flexible, coated heating elements for seat base and back are placed between the upholstery and seat cover without altering the shape of the seats. The heater is connected to the 12V on-board power supply using a ready-made cable set with switches for the drivers seat and passengers seat with the heat output able to be set at two stages. Integrated temperature sensors protect against overheating. The seat heater can be fitted in any vehicle with a removable cover.

- > Complete set for two seats.
- > Extra comfort with 2 heating levels
Stage I = pleasant permanent heat & Stage II = heat-up.
- > Installation kit for driver's seat and front passenger's seat with four heating elements.
- > Pre-assembled cable set with switching relay and two illuminated switches for universal use.
- > Integrated temperature guard.
- > Heating elements made of extremely flexible coated wires.
- > For seats with removable covers.
- > Fitting materials & instructions.

Operating voltage - 12 volt; Output - Stage I: 44 watts & Stage II: 90 watts
Dimensions - Seat: 400 x 280mm & Backrest: 300 x 280mm
Test mark - e-approved to 95/54/EC (EMC guidelines for vehicles)

Defender & Series - Rear Seats

Black Seats		
320737	Bench seat (810mm wide)	Rear assembly (inc. full fitting kit)
320647	Bench seat (810mm wide)	Rear back
396739	Bench seat (810mm wide)	Rear back - metal backed
320674	Bench seat (810mm wide)	Rear base
DA3059	Bench seat (1,200mm wide) - LWB	Rear assembly (inc. full fitting kit)
DA4067	Rear seat	Individual inward facing

County Brown Seats		
320737CB	Bench seat (810mm wide)	Rear assembly (inc. full fitting kit)
320647CB	Bench seat (810mm wide)	Rear back
320674CB	Bench seat (810mm wide)	Rear base

County Grey Seats		
320737CG	Bench seat (810mm wide)	Rear assembly (inc. full fitting kit)
320647CG	Bench seat (810mm wide)	Rear back
320674CG	Bench seat (810mm wide)	Rear base

Grey Seats		
320737LCS	Bench seat (810mm wide)	Rear assembly (inc. full fitting kit)
320647LCS	Bench seat (810mm wide)	Rear back
320674LCS	Bench seat (810mm wide)	Rear base
DA3059LCS	Bench seat (1,200mm wide) - LWB	Rear assembly (inc. full fitting kit)
DA4075	Rear seat	Individual inward facing

Techno Style Seats		
320737T	Bench seat (810mm wide)	Rear assembly (inc. full fitting kit)
320647T	Bench seat (810mm wide)	Rear back
320674T	Bench seat (810mm wide)	Rear base
DA3059T	Bench seat (1,200mm wide) - LWB	Rear assembly (inc. full fitting kit)
DA4075T	Rear seat	Individual inward facing

Vinyl Twill Seats		
320737RPI	Bench seat (810mm wide)	Rear assembly (inc. full fitting kit)
320647RPI	Bench seat (810mm wide)	Rear back
320674RPI	Bench seat (810mm wide)	Rear base
DA3059RPI	Bench seat (1,200mm wide) - LWB	Rear assembly (inc. full fitting kit)
DA4075RPI	Rear seat	Individual inward facing



All products leaving the Trim Shop are manufactured to the highest standard.



Re-trim Kits



Outer Seats
Defender - from VIN AA677964 to 2007 (non-plastic backed front squab)
An outer Britpart re-trim kit includes:
1 x Can of contact adhesive spray
1 x Squab foam
1 x Squab cover
6 x Plastic nails
3 x Cable ties

Kit excluding adhesive spray		
DA5627	DA5627E NEW	Vinyl twill
DA5628	DA5628E NEW	Techno
DA5629	DA5629E NEW	Black
DA5630	DA5630E NEW	Grey

DA5636 DA5636E NEW
XS style
Outer - Black
Inner - Charcoal



Outer Seats
Defender - 2007 onwards
An outer Britpart re-trim kit includes:
1 x Can of contact adhesive spray
1 x Squab foam
1 x Squab cover
2 x Metal rods
1 x Rubber retainer

Kit excluding adhesive spray		
DA5675 NEW	DA5675E NEW	Vinyl twill
DA5676 NEW	DA5676E NEW	Techno
DA5673 NEW	DA5673E NEW	Black
DA5674 NEW	DA5674E NEW	Grey

Online Fitting Guide

We have compiled a 25 minute tutorial giving you detailed step-by-step on how to disassemble and assemble your Defender seat and information on the correct use of the included parts. The video can be found at www.britpart.com/re-trim



Centre Seats
Defender - 1990 onwards
A centre Britpart re-trim kit includes:
1 x Can of contact adhesive spray
1 x Squab foam
1 x Squab cover
1 x Metal rods

Kit excluding adhesive spray		
DA5632	DA5632E NEW	Vinyl twill
DA5633	DA5633E NEW	Techno
DA5634	DA5634E NEW	Black
DA5635	DA5635E NEW	Grey

Off-roading? Got a working Land Rover?

Well the chances are your seats won't be in showroom condition, luckily Britpart have the answer - a Defender re-trim kit.

Sparco Seats



DA7301	Black leatherette
DA7302	Black/blue
DA7303	Black/grey
DA7304	Black/black
DA7305	Black/red
DA7306	Seat runners
DA7307	Mounting kit - removable
DA7308	Mounting kit - fixed



- > Lightweight and compact
- > High comfort
- > Tubular frame construction
- > High quality recline mechanism for smooth and easy adjustment
- > Compatible with 3 or 4 fixing point harnesses
- > Base mounted - 271 x 345mm



These Sparco seats are ideal for the Defender (excluding truck cabs*). Drawing on decades of racing history, Sparco has created a line of street car seats that offer the ultimate in comfort and performance. The ergonomic designs help cradle and protect the driver against even the most demanding lateral forces. The R100 is Sparco's latest incarnation of ground-breaking steel-model seats. It features redesigned bolsters for greater support and new padding configurations for improved comfort. It has been built with comfort and support in mind but it's lower side bolsters and slightly narrower steel frame allow it to fit into vehicles where fitting seats with larger side bolsters may be difficult. The seat features backrest harness slots so that it can be used with a race type harness or normal seatbelts. The seats can be reclined using the double adjuster lever. Made from a durable fabric, the R100 is available in single tone or duo-tone styles. Duo-tone styles feature contrasting side accenting and stitching to match any interior. The Sparco R100 range is designed to attach using Sparco vehicle specific seat mounts.

*Not suitable for vehicles with truck cabs fitted as they restrict the leg room in the vehicle.

Corbeau Seats NEW

Corbeau Sportline RRS Low Base Seats

A revised version of the RSS, the Low Base has been designed specifically for Defender owners. The RRS has up-to-the-minute styling, giving you the ultimate in comfort and safety. This steel-framed sports recliner has a high quality moulded foam cushion, with lumbar support to give maximum comfort whilst not compromising lateral support. With its ultra low side bolster this is the perfect application for any high rise vehicle. Fitted with a high quality single reclining and tilting mechanism for ease of adjustment. TUV Approved. Sold in pairs.

Dimensions

Base width	500mm
Length	560mm
Height	930mm
Shoulder width	540mm
Thigh width	350mm



DA7310 NEW	Vinyl
DA7311 NEW	Dakota leather
DA7312 NEW	Leather & Alcantara



Corbeau seat mounting kit
DA7313 NEW Pair



Corbeau Harness Pads

Provide extra padding for all seat belt widths. The harness pads can be used for on road, off-road or competition.

- > Provides extra padding for all seat belt widths.
- > Supplied as a pair.
- > Suitable for 50mm harness straps.
- > Velcro fastening.

DA7314 NEW	Red
DA7315 NEW	Blue
DA7316 NEW	Black

XS Style Seats



Hand-built in the UK, these quality XS style seats are suitable for Defenders. Well-crafted with precision tools using a hard wearing leatherette outer and velour trim inner. Comfort is ensured with injection moulded foam. Seats complete with base, back and headrest but the runners are not included.

	Outer	Inner	Side
DA5610	Dark grey	Light grey	RHS
DA5611	Dark grey	Light grey	LHS
DA5615	Black	Blue	LHS
DA5616	Dark brown	Light brown	RHS
DA5617	Dark brown	Light brown	LHS
DA5618	Black	Charcoal	RHS
DA5619	Black	Charcoal	LHS
HHD102280	Runner & sub-frame		RHS
HHD102290	Runner & sub-frame		LHS
Re-trim Kit - see re-trim section for full kit details.			
DA5636	Black	Charcoal	



Trade Tack Stab

DA6348
Super bond spray adhesive.
> High strength
> Variable spray
> Quick
> Clean
> High tack/long tack
> Very fast set
> 250ml aerosol
Ideal for bonding and laminating of polyurethane foam, polystyrene foam, fibres, fabrics & felts etc to themselves.



Trim



Dash Trim Kits

Put a stop to the dreaded Discovery 1 dash peel with one of these repair kits.

- Discovery 1**
DA2090 Black
DA2091 Blue
DA2096 Grey
DA2098 Brown

Chain Cover



330422
 Defender - 1987 - 2006/Series
 Stop your tailgate chain rattling away with this easy to fit chain cover. Single. Requires 2 per side.

Door Trim

Replace the tatty old door cards in your Defender with one of these smart plastic replacements. Easy to fit, they are also easy to keep clean with a wipe clean finish.

DA2440	Defender - 1987 - 2006	Front casing	Manual window	Black	RHS
DA2441	Defender - 1987 - 2006	Front casing	Manual window	Black	LHS
DA2442	Defender - 1987 - 2006	Front casing	Manual window	Grey	RHS
DA2443	Defender - 1987 - 2006	Front casing	Manual window	Grey	LHS
DA2490	Defender - 1987 - 2006	Front casing	Manual window	Light Grey	RHS
DA2491	Defender - 1987 - 2006	Front casing	Manual window	Light Grey	LHS
DA2444	Defender - 1987 - 2006	Front casing	Electric window	Black	RHS
DA2445	Defender - 1987 - 2006	Front casing	Electric window	Black	LHS
DA2446	Defender - 1987 - 2006	Front casing	Electric window	Grey	RHS
DA2447	Defender - 1987 - 2006	Front casing	Electric window	Grey	LHS
DA2494	Defender - 1987 - 2006	Front casing	Electric window	Light Grey	RHS
DA2495	Defender - 1987 - 2006	Front casing	Electric window	Light Grey	LHS
DA2480	Defender	Rear casing	Manual window	Black	RHS
DA2481	Defender	Rear casing	Manual window	Black	LHS
DA2482	Defender	Rear casing	Manual window	Grey	RHS
DA2483	Defender	Rear casing	Manual window	Grey	LHS
DA2492	Defender	Rear casing	Manual window	Light Grey	RHS
DA2493	Defender	Rear casing	Manual window	Light Grey	LHS
DA2484	Defender	Rear casing	Electric window	Black	RHS
DA2485	Defender	Rear casing	Electric window	Black	LHS
DA2486	Defender	Rear casing	Electric window	Grey	RHS
DA2487	Defender	Rear casing	Electric window	Grey	LHS
DA2496	Defender	Rear casing	Electric window	Light Grey	RHS
DA2497	Defender	Rear casing	Electric window	Light Grey	LHS

Seat Handle & Cover Kit NEW



DA5495 NEW
 A pair of Defender seat handles and covers

Door Stays



DA1203
 Does your Defender's rear door sometimes close on you unexpectedly?
 This neat and easily installed gas strut kit will solve that problem and replaces the original door stopper. The gas strut will hold the door in place when open - even with a spare wheel in place - and will assist in the opening of the rear door too with a smoother and more controlled movement. Complete with fittings and instructions.

DA1204 Defender - up to 2002
DA1203 Defender - 2002 onwards



Rear door cards for Defender 1987 - 2006 with wash wipe doors. Fixings not included

MXC1992LCS	Defender - FA358393 up to JA910753	Slate Grey
BTR3793LCS	Defender - JA910754 up to KA929577	Slate Grey
BTR7959LCS	Defender - KA929578 up to MA965105	Slate Grey
BTR9712LCS	Defender - MA965106 up to TA99921	Slate Grey
BTR9712LOY	Defender - MA965106 up to TA99921	Dark Granite
BTR9712PMA	Defender - MA965106 up to TA99921	Black

For more images visit www.britpart.com/door-trim

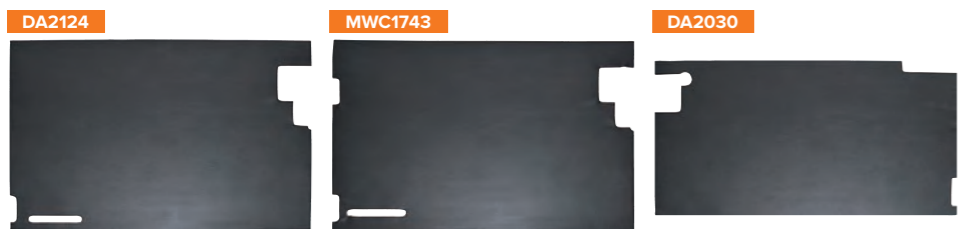

DA2124	Defender/Series	Door trim safari - 2 hinges	Black	Rear
MWC1743	Defender	Door trim safari - 3 hinges	Black	Rear
DA2029	Series	Door trim lower	Black	RHS
DA2030	Series	Door trim lower	Black	LHS

Note - Fixings not included.

Off-Road Equipment

Off-roading can present many unexpected challenges. Make sure that your Land Rover is prepared with our range of off-road equipment. From recovery kits to long range fuel tanks, there is a wide selection of essentials for your off-road adventures.

- Air Compressors** 82
- Diff Lockers**
 - ARB 82 - 83
 - Ashcroft Transmission 83
 - Detroit 84
 - Diff lock lever kit 84
 - LT230 cross pin 84
- Emergency Equipment**
 - Emergency hammer 85
 - Fire extinguishers 85
 - First aid & travel kits 84
 - Recovery kits 85
- Fuel Storage**
 - Long range fuel tanks 85
 - Jerry cans 85
- Ground Anchor** 87
- Jacks**
 - Anti-rattle jack clamps 87
 - Bottle jack 87
 - Hi-Lift 86
 - Jack base 87
 - Jackall 86
- Sand Ladder & Waffle Boards** 87
- Land Meters** 87
- Lift Rod Kit** 87
- PowerPacks** 88
- Raised Air Intakes**
 - Other 88
 - Safari 89
- Tyre Repair Kit** 82



Air Compressors

Double Pump



- Features for both air compressors**
- > Max. pressure - 150psi.
 - > Automatic cut off to prevent overheating.
 - > 10 metre air hose with heavy-duty gauge and brass fittings.
 - > Integrated sand tray.
 - > Blow moulded carrying case.
 - > Also great for camping and outdoor use.

- DA2392**
Double-pump air compressor
- > Air flow - 150ltr/min
 - > 12 volt / 50 amp
- DA2354**
Single-pump air compressor
- > Air flow - 72ltr/min
 - > 12 volt / 30 amp

- DA2394**
Replacement cap and filter for DA2392 & DA2354
- DA2354FUSE40A NEW**
Replacement fuse for DA2354
- DA2392FUSE50A NEW**
Replacement fuse for DA2392

GREAT FEATURES...

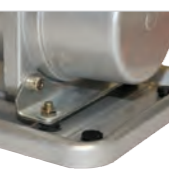

ARB

Diff Lockers

ARB Compressors

- DA4190**
High output 12 volt on-board compressor assembly
- > Airflow - 87.2lpm
 - > Designed for Air Locker use.
 - > High flow, compact 12v compressor.
 - > Sealed for moisture and dust resistance.
 - > Hard anodised cylinder bore and Teflon impregnated carbon fibre piston seal for reduced friction and maximum trouble free life.
 - > Heavy-duty maxi-fuse equipped for professional in-line circuit protection.
 - > Quality components for quiet operation and extra long life.
 - > Anodised mounting brackets dissipates motor heat and allows compressor to be repositioned by 180°.
 - > Constructed entirely of lightweight, high strength engineering grade materials.
 - > Over-pressure safety valve equipped.
 - > Motor is internally thermal protected against extreme temperature damage.

- DA4958 NEW**
Compact 12 volt on-board compressor assembly
- > Airflow - 27.7lpm
 - > Designed for Air Locker use.
 - > Compact, vehicle mounted design.
 - > Sealed for moisture & dust resistance.
 - > Quality components for quiet operation & extra long life.
 - > Mounting bracket allows for versatile positioning.
 - > Kit contains 12V air compressor, mounting bracket & hardware, auto on/off pressure switch, plug-in Air Locker wiring loom and installation instructions.



Also available in black



- DA4194** Dash switch for compressor and lockers
- DA4360** Front locker dash switch cover
- DA4361** Rear locker dash switch cover
- DA4362** Compressor dash switch cover



DA8926 NEW Red

DA8934 NEW Black

ARB Diff cover. Defender - front and rear Salisbury axles. High tensile solid nodular iron structure (tougher and harder than solid carbon steel) protects the differential and ring & pinion set from the obstacle impact hazards of competition rock crawling, or extreme off road trails. More information available online.

More tyre maintenance products available.

See Wheels section.

Tyre Repair Kit

Don't get caught out with a flat tyre or two!

Pack and leave an easy to use Britpart tyre repair kit in your vehicle.*

DA2390
Tyre repair kit in travel case. See the wheels section for more details on the tyre repair kit from Britpart.

* Recommended for off-road use only.



ARB - continued

ARB Diff Lockers

- > Provides 100% traction on demand without affecting on road driveability or driveline wear.
- > Vastly improved traction means less reliance on momentum, thus reducing the likelihood of vehicle damage and environmental impact.
- > Easy, convenient operation allows the driver to concentrate on the terrain without leaving the comfort and safety of their seat.
- > Ultra durable and extremely strong - only the highest quality materials used in construction.
- > Incredibly simple yet effective design that employs minimal moving parts, thereby ensuring maximum reliability.
- > Thoroughly tested and proven design - trusted and used in over 80 countries around the world.
- > Easy installation and maintenance - no special tools, skills or additives required.
- > Two year warranty guarantees the Air Locker will be free of defects in materials.

Air Locker locking differentials allow you to tackle the toughest terrain. As the world's premier traction aid, ARB Air Lockers keep you moving in all conditions. Ultra durable and extremely strong - only the highest quality materials used in construction.



Part Number Series	Vehicle/Model	Year	Axle Location	Shaft Description	Shaft Diameter	Spline	Ratio
DA4191 2,3	Series 1/Series 2/Series 3	1948 - 1985	Front	Rover type	28.2 (1.11")	10	4.7
DA4191 2,3	Series 1/Series 2/Series 3	1948 - 1985	Rear	Rover type	28.2 (1.11")	10	4.7
Defender							
DA4191 1	Defender 90	1984 - 1993	Front	Rover type	28.2 (1.11")	10	3.54
DA4193 1,5	Defender 90	1993 onwards	Front	Rover type	31.5 (1.24")	24	3.54
DA4193 1,6	Defender 90	2007 onwards	Front	Rover type	31.5 (1.24")	24	3.54
DA4191 1,2	Defender 90	1983 - 1993	Rear	Rover type, 4 cyl. petrol & diesel engines	28.2 (1.11")	10	3.54
DA4193 1,6	Defender 90	1993 onwards	Rear	Rover type	31.5 (1.24")	24	3.54
DA4344 6	Defender 90	2002 onwards	Rear	Rover type, P38A	31.5 (1.24")	24	3.54
DA4193 1,6	Defender 90 with 2 pin rear diff	2007 onwards	Rear	Rover type	31.5 (1.24")	24	3.54
DA4344 6	Defender 90 with 4 pin rear diff	2007 onwards	Rear	Rover type, P38A	31.5 (1.24")	24	3.54
DA4191 1	Defender 110/130	1983 - 1993	Front	Rover type	28.2 (1.11")	10	3.54
DA4193 1,5	Defender 110/130	1993 onwards	Front	Rover type	31.5 (1.24")	24	3.54
DA4193 1,6	Defender 110/130	2007 onwards	Front	Rover type	31.5 (1.24")	24	3.54
DA4192 6	Defender 110/130	1983 - 2002	Rear	Salisbury type	31.5 (1.24")	24	3.54
DA4193 6	Defender 110/130	2002 onwards	Rear	Rover type	31.5 (1.24")	24	3.54
DA4344 6	Defender 110/130	2002 onwards	Rear	Rover type, P38A	31.5 (1.24")	24	3.54
DA4344 6	Defender 110/130	2007 onwards	Rear	Rover type, P38A	31.5 (1.24")	24	3.54
Discovery							
DA4191 1	Discovery 1	Up to 1993	Front	Rover type	28.2 (1.11")	10	3.54
DA4193 1,5	Discovery 1	1993 - 1998	Front	Rover type	31.5 (1.24")	24	3.54
DA4191 1	Discovery 1	Up to 1993	Rear	Rover type	28.2 (1.11")	10	3.54
DA4193 1,5	Discovery 1	1993 - 1998	Rear	Rover type	31.5 (1.24")	24	3.54
DA4193 1,5	Discovery 2	All	Front	Rover type	31.5 (1.24")	24	3.54
DA4193 6	Discovery 2	All	Rear	Rover type	31.5 (1.24")	24	3.54
DA4344 6	Discovery 2	2002 onwards	Rear	Rover type, P38A	31.5 (1.24")	24	3.54
DA6254 6	Discovery 3	All	Front	IRS, Clamshell type	31.5 (1.24")	29	All
Note	- Check diff ratio before ordering this part.						
DA6252 6	Discovery 3	All	Rear	IRS, Clamshell type	33.6 (1.32")	31	All
DA6254 6	Discovery 4	All	Front	IRS, Clamshell type	31.5 (1.24")	29	All
Range Rover							
DA4191 1,4	Range Rover Classic	Up to 1992	Front	Rover type	28.2 (1.11")	10	3.54
DA4193 1,5	Range Rover Classic	1993 - 1996	Front	Rover type	31.5 (1.24")	24	3.54
DA4191 1,4	Range Rover Classic	Up to 1992	Rear	Rover type	28.2 (1.11")	10	3.54
DA4193 1,5	Range Rover Classic	1993 - 1996	Rear	Rover type	31.5 (1.24")	24	3.54
DA4344 5	Range Rover P38	1996 - 2002	Front	Rover type, P38A	31.5 (1.24")	24	3.54
DA4344 5	Range Rover P38	1996 - 2002	Rear	Rover type, P38A	31.5 (1.24")	24	3.54
DA6254 6	Range Rover Sport	2005 - 2013	Front	IRS, Clamshell type	31.5 (1.24")	29	All

Notes - 1. If vehicle was manufactured during 1993, check spline count. **2.** Air Locker not available for vehicles equipped with high load option. **3.** Ring gear spacer required. Longer ring gear bolts (not supplied) are also necessary - (Land Rover part no. 576521). **4.** When an DA4191 Air Locker is to be installed in Range Rovers manufactured prior to 1980 (approx.), special carrier bearings (No. K11300/K1162) may also be necessary - Land Rover part no. RTC3426. **5.** Some vehicles have crown wheel bolts which cannot be reused and must be replaced. Consult service manual. **6.** P38A is most commonly found in traction control equipped vehicles. Identify P38A type diff by large 205mm [8.07"] flange diameter. P38A was not used on North American delivered Discoverys - use DA4193.

Ashcroft Transmissions



Features

- > A unique non-rotating annular piston locking actuator is designed to eliminate air leaks sometimes found with rotating seals.
- > The annular piston is also designed to eliminate the oil blow back in the air exhaust line.
- > The large piston area gives maximum hold-in force to reduce the possibility of jumping out of lock.
- > Locking ring gives full 6mm positive engagement with side gear, again reducing the possibility of jumping out of lock.
- > Gears have been redesigned for maximum strength and durability.
- > The lock ring is made from high spec 300m steel to provide ultimate strength and ability to withstand shock loads.
- > Locking actuator cage made from steel to withstand shock loading caused by power locking.
- > Locker body turned from billet 817M40T (EN24T) to give optimum strength.
- > Only change necessary to fit the locker is drill and tap the diff housing 1/4" bsp for the air feed fitting.
- > No changes to the axle case.
- > Requires on board air supply - not supplied.

DA1224

Defender - 1993 onwards	Front & Rear
Discovery 1 - 1993 - 1998	Front & Rear
Discovery 2	Front & Rear
Range Rover Classic - 1993 - 1996	Front & Rear
DA1224SN	Rear
Defender 110 - 2002 onwards (Wolf)	Front & Rear
Range Rover P38	Front & Rear



Diff Lock Lever Kit

DA1178
Discovery 2
Early Discovery 2's were not supplied with a centre diff lock function for the LT230 transfer case although the vehicles still have the centre diff lock installed in the transfer case. To get the diff lock function to work it just needs connecting. The linkage is easy to fit, cable operated and very neat. You attach the existing high/low stud to this new lever assembly. This kit will only work on transfer cases with serial numbers starting with either 41D or 42D.

LT230 Cross Pin

DA1225
Ashcroft Transmissions cross pin
The standard LT230 transfer boxes have a two piece cross pin in the centre diff, this is two shafts with a cut out in the centre so they can overlap. This one piece heavy-duty cross pin is much stronger.



Photo courtesy of Jo Pritchard

Detroit

Detroit Locker

- > 100% locking differential
- > Legendary traction
- > Ultimate performance

The legendary Detroit Locker began the revolution in performance differentials and still leads the industry today as an Eaton brand. The Detroit Locker is the most durable and dependable locking differential available.

The Detroit Locker maximises traction by delivering 100% of the torque to both drive wheels. It is engineered to keep both wheels in a constant drive mode, and has the ability to automatically allow wheel speed differentiation when required.

No other performance differential has the reputation for delivering traction in mud, snow, rocks and on the track. The choice of professional racers and off-road enthusiasts around the world! The durability of the Detroit Locker is unmatched!

DA5700	Series 3/Defender/Discovery 1/Range Rover Classic	24 spline	Rear
DA5701	Series 3/Defender/Discovery 1/Range Rover Classic	10 spline	Rear
DA5704	Defender - Salisbury axle Detroit Locker	24 spline	Rear

Detroit Truetrac

- > Smooth operation
- > Performs open until needed
- > Fully automatic limited slip

The Detroit Truetrac was the first helical gear differential ever introduced into the automotive aftermarket as an Eaton brand. It remains the leading helical gear-type limited slip differential in the industry. Detroit Truetrac's proven helical gear design eliminates the need for wearable parts, resulting in maintenance free traction.

Recognised not only for its toughness but also its smooth and quiet operation. Engineered to work efficiently in front and rear axles, semi-floating (C-clip axles) and transfer cases. Power transfer is so smooth, it literally goes unnoticed by the driver - even in front wheel drive axles.

Proven design, low cost and effective performance, all make the Detroit Truetrac limited slip differential the ideal choice for a wide variety of vehicle applications.

DA5705	Series 3/Defender/Discovery 1/Range Rover Classic	10 spline	Rear
DA5706	Series 3/Defender/Discovery 1/Discovery 2/Range Rover Classic	10 spline	Front
DA5709	Series 3/Defender/Discovery 1/Discovery 2/Range Rover Classic	24 spline	Rear
DA5710	Series 3/Defender/Discovery 1/Discovery 2/Range Rover Classic	24 spline	Front
DA5711	Defender - Salisbury axle	24 spline	Rear



"The choice of professional racers & off-road enthusiasts around the world."



IMPORTANT

When fitting a metric diff centre with metric bearings into an imperial casing you will require the additional following parts. Diffs went from imperial to metric in approximately 1983, take a look at one of the heads of the four large journal end cap bolts, if '8.8' is on the head it is metric, if not then it is imperial. Parts are required for fitting to both Truetrac or Detroit lockers.

DA5712	Spacer ring
DA5713	Imperial bearing sleeves
RTC3095	Bearings. 2 x bearings are required
576521	Longer bolts x 10

Fitting a Detroit Truetrac to the rear of a late Defender 110 will require the spacer ring DA5712. Ten longer bolts are needed too 576521 is a pack of 10.

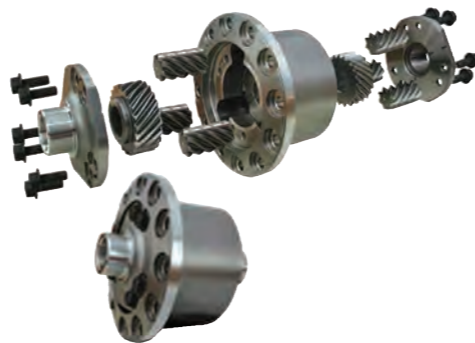

"Recognised for its toughness as well as its smooth & quiet operation."

For first aid & travel kit contents details
www.britpart.com/safety

Emergency Equipment

First Aid & Travel Kits



DA5031
Compact First Aid Kit
Lightweight, compact carry case. Great for people on the move and ideal for treating minor injuries. Contents are CE certified.



DA5032
Standard First Aid Kit
Comprehensive range of essential items in a handy case. Contents are CE certified and are in conjunction with DIN 13164.



DA5033
Essential Emergency Travel Kit
Essential items for emergencies on the roadside. Compact carry case. Ideal size to store in front of the vehicle for easy access.



DA5028
European Travel Kit
Includes essential items when travelling to Europe. All products are manufactured to UK required standards where applicable.



DA5029
Glovebox Travel Kit
Ideal size to fit into your glove compartment, contains essential everyday items for in & around the vehicle.

Emergency Hammer

DA6500
Life Hammer - The Original
> Double-sided steel hammer for shattering windows quickly and easily for a safe and quick exit from any vehicle.
> Razor sharp blade cuts through seatbelts to ease escape.
> Fluorescent button allows hammer to be located in the dark.
> Installation mounting bracket ensures hammer is accessible when you most need it.



Fire Extinguishers

STC8138AB
> 2kg kit.
> Long-life - 100% polyester resin coated fire extinguisher.
> Safe handling & crash proof fastening.
> Readiness to operate displayed by manometer.
> Precision brass valve.



STC8529AA
> 1kg kit.
> One-handed operation fire extinguisher.
> High rating.
> Checkable & re-chargeable.
> With crash-tested bracket.
> Attractive design.
> Controlled discharge.

Recovery Kits



With a recovery kit you have the peace of mind carrying a purpose-built recovery bag filled with a selection of items that will come in handy the next time you get stuck.

DA8932 NEW
ARB Premium Recovery Kit
> 8,000kg snatch strap
> 4,500kg winch extension strap
> 12,000kg tree trunk protector
> 9,000kg snatch block
> Recovery damper
> Winch pack storage bag
> Bow shackles and gloves

DA8928 NEW
ARB Essentials Recovery Kit
> 8,000kg snatch strap
> 12,000kg tree trunk protector
> 9,000kg snatch block
> Snatch pack storage bag
> Bow shackles

DB1015
Britpart Recovery Kit
> Wheel chocks
> 9,000kg snatch block -
> 8,000kg tow strap
> 8,000kg snatch tow sling
> Bow shackles
> Tree strap
> Winching gloves
> Winching blanket
> Winch kit bag



Fuel Storage

Defender 90
DA4547
Defender 90 - Td5 & Tdci - up to 8A
DA4548
Defender 90 - Tdci - from 8A
> 30 litres* plastic flow tank
> Lightweight
> Supplied as kit
> Easy to install & use
> Requires no pumps or added fillers
> Does not interfere with storage or clearance
> Compatible with standard Defender fuel filler cap *approximately

The best way of getting more fuel into your Defender without using valuable space or complex pumping systems!



Long Range Fuel Tanks

Defender 110
DA4545
Defender 110 - up to 1999 (pre-Td5 models)
> Rear arch metal spare fuel tank - right hand side
> 45 litres
> Supplied with all the necessary fittings to install and use
DA4546
Defender 110 - 1999 onwards (Td5 & Puma models)
> Rear arch metal spare fuel tank - right hand side
> 45 litres
> Supplied with all the necessary fittings as well as a replacement filler neck and specifically engineered bulkhead fitting for the balance pipe, having these makes the fitting of the tank quicker and easier as well as it working better too.

Note - Both above tanks are not suitable for use in a Defender 130. Additional bracket required for 7 seater.

DA4546KIT NEW
The long range fuel tank DA4546 will require this additional bracket when fitting to a 7-seater Defender.

Jerry Cans



DA2166
Jerry can - 20ltr
DA2170
Jerry can - 20ltr stainless steel
DA2171
Jerry can - 10ltr stainless steel
DA2172
Jerry can stainless steel spout
DA2182
Jerry can holder for 20ltr cans



Don't get caught short!

Jacks

Hi-Lift

Rugged & Highly Versatile Jacks

The Hi-Lift jack is a rugged, highly versatile jack that puts you in command of situations requiring lifting, pushing, pulling, winching, and clamping. Although light in weight and easy to manoeuvre, the Hi-Lift jack offers a rated lifting capacity of 2½ tons (2,114kg).



Accessories

- DA2174** Off-road base plate - Alleviates jack sinkage on soft surfaces - suits both models
- DA2243EYE** Jacking eye - Spare jacking eye
- DA2244** Jacking point adaptor - Allows the use of the jack with the standard jacking points on a Defender
- DA2248** Fix-it-kit - The maintenance kit contains all the key components for servicing all Hi-Lift jacks
- DA4350** 4XRAC - Heavy-duty mounting system for the serious off-roader
- DA4351** Loc-Rac - Conveniently mounts and locks your Hi-Lift jack. Includes lock and suits all models
- DA4352** Jack protector - The jack protector vinyl bag protects your jack from the elements - one size fits all
- DA4353** Lift mate - Designed to provide a lift point from most wheels for quick and easy lifting. Lifting capacity is 5,000lbs/2,273kg
- DA4354** Off-road kit - The Hi-Lift winching kit includes a winch attachment, winch tensioner, tree strap, d-ring shackle, Hi-Lift gloves and gear bag. Winch time is reduced significantly using the winch attachment and tensioner together.
- DA4355** Bumper lift - Designed to fit curved steel bumpers. Rugged design of the bumper lift has a lifting capacity of 3,000lbs/1,361kg
- DA4356** Neoprene jack cover - This jack cover offers a level of mud and dirt protection for the main lifting mechanism of the jack when not in use. It zips on easily over the foot of the jack and provides a tight fit.
- DA4357** Adjustable tube jack mounts - small set - For use on tubes from 1 to 2" in diameter, which works on many roof racks. It can also be used on ATV/UTV bars, bumpers and roll cages.
- DA4358** Adjustable tube jack mounts - large set - For use on tubes from 2 to 3" in diameter that will work on most vehicle bull bars and roll cages.

Jackall

Built with a patented 'Safety Link', the Maasdam Jackall is the 'Jack with More!' Larger base for greater stability. 'Safety Link' mechanism that prevents abuse, misuse and makes operations safer. Jacks come with a lifetime warranty and are built to current ANSI/ASME specifications. When safety and dependability matter most, continue to rely on Jackall.

Features & Benefits

- > Patented 'safety link' mechanism which prevents abuse and misuse.
- > Heavy ribbed, extra large base which provides strength and greater load stability.
- > Cast components assures long life, trouble free operation.
- > Hot roll-formed, alloy steel beam which is strong and reliable.
- > Steel handle locks against beam for convenient storage.
- > Powder coated through and through which reduces scratching, greater corrosive resistance.

- DA3121** 48" Jack (4ft) - 8,000lbs capacity
- DA3122** 60" Jack (5ft) - 8,000lbs capacity
- DA3130** Top clamp
- DA4058** Maintenance kit
- DA4059** Jacking point adaptor
- DA4061** Mounting kit jack rack

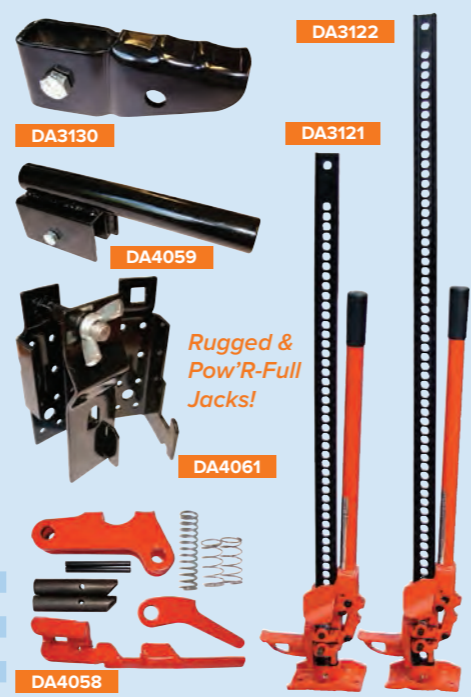

- DA2243** 48" Jack (4ft)
- DA3120** 60" Jack (5ft)

Specifications

- > Approximate weight: 30lbs (14kg).
 - > 4,660lbs (2,113kg) rated capacity.
 - > Climbing pins of specially processed steel with 125,000psi tensile strength and 100,000psi yield.
 - > Steel bar is manufactured of specially rolled extra high carbon steel with 80,000lbs minimum tensile and carbon 0.69 to 0.82.
 - > Steel handle of 14-gauge high-yield structural tubing with minimum yield of 55,000psi - 5/16" diameter x 30" long.
- Features
- > Every jack comes complete with an adjustable top clam clevis for use in clamping and winching.
 - > For speedy disengaging, lifting unit automatically drops away when load is removed.
 - > 4½" (11cm) long lifting nose for positive contact with load.
 - > Safety bolt is designed to shear at 7,000lbs (3,175 kg).
 - > Steel bar can be reversed for extra long life.
 - > Low pickup of 4½" (110mm).
 - > 28" square base plate.

Anti-rattle Jack Clamps

- DA3153** Red
- DA3154** Black
- DA3155** Yellow



Ground Anchor NEW

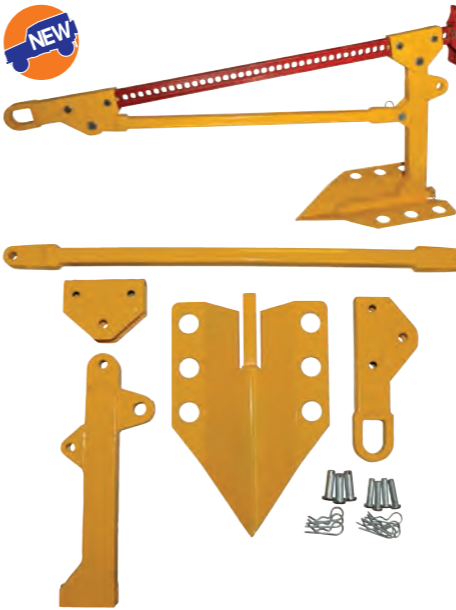

DA6541 NEW
Ground anchor
Pull yourself out of trouble with this heavy-duty ground anchor. This anchor utilises a Hi-Lift jack (not included).



Photo courtesy of Peter Field

Bottle Jack

- ANR4489** Bottle jack kit (LR031924 & KAH000050)
- LR031924** Bottle jack
- KAH000050** Handle for bottle jack (LR031924)
- Note - Defender only



Jack Base

- DA5607** Jack base 310 x 195 x 38mm Grey

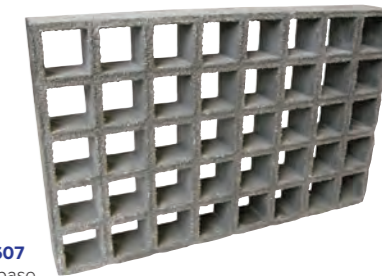

Sand Ladder & Waffle Boards



Help to get yourself out of trouble...

DA2231	Sandtrack	Aluminium	Pair
	1,500 long x 390 wide x 4mm thick		
DA5600	Waffle boards	Fibreglass	Pair
	1,220 long x 260 wide x 50mm deep Grey with gritted surface for extra traction		
DA5601	Waffle boards	Fibreglass	Pair
	1,220 long x 270 wide x 38mm deep Grey with gritted surface for extra traction		
DA4587	Recovery tracks	Plastic	Pair
	1,210 long x 325 wide x 60mm deep Max load - 3.5 tons		



NEW
Sign up to the regular Britpart newsletter to find out about all the latest product releases.
www.britpart.com/newsletter

Land Meters

- > Independent twin meter.
- > Convenient for seeing the pitching and rolling of the vehicle body or terrain.
- > Transparent illumination for easy-to-see readings at night.

- DA1003** Double incline land meter Black
- DA1004** Double incline land meter Carbon fibre effect



Lift Rod Kit



DA7531
Fully adjustable suspension lift rod kit
Discovery 3/Discovery 4/Range Rover Sport - 2005 - 2013

"The ease of changing the ride height is what separates these rods from others in the marketplace."

These adjustable rods replace the plastic and rubber parts Land Rover supply on the vehicle. Made from aluminium with an industrial heavy grade rubber bushing, the aluminium parts are anodised black to help with corrosion protection and blending in when in the garage for work.

The lift rods have two settings; standard and off-road. With the vehicle set to normal driving height the shortened rods will give you off-road height. If you select off-road height the vehicle will be in the 'super extended' position as standard if you use the 'shortened' settings. The ease of changing the ride height is what separates these rods from others in the marketplace.

No tools are required and should take no more than 2 minutes to do all four rods.

Access to the front is over the front wheels and for the back is through the rear wishbones (blanket required!)

Note - If run for a long time in off-road position then wheels may need realigning.

PowerPacks

XS PowerPack
MULTI-FUNCTION JUMP STARTER

XD PowerPack
MULTI-FUNCTION JUMP STARTER



- DA1239 UK mains plug
- DA1239EU NEW EU mains plug
- DA1256 NEW Replacement jump leads for DA1239
- DA1255 NEW 12V cigarette lighter adaptor

DA1238 UK mains plug

Technical Specifications
Battery volume: 9,000mAh
Starting current: 200A

Technical Specifications

Battery volume: 18,000mAh
Starting current: 300A

Size: 230 x 87 x 27mm
Weight: 615g
Output: 5V = 2A (smart phone/tablet fast charge)
12V = 10A
19V = 3.5A (laptops/notebooks)

Input: 14V = 1A
Peak current: 600A

Size: 131 x 75 x 25mm
Weight: 300g
Output: 5V = 2A (smart phone/tablet fast charge)
Input: 14V = 1A
Peak current: 400A

- > Small and lightweight portable power pack with the latest nano lithium battery technology.
- > High capacity, high power special battery.
- > Supports fast charging with low self-discharge cycle.
- > Charging cycles can reach more than 1,000 times.
- > Supports 12V jump starts as well as back up charging for many brands of mobile phones, tablets etc.

The XS & XD PowerPacks are handy to keep with you on your travels to ensure you never run out of 'juice'!

See them both in action at www.britpart.com/powerpack



Jump Starter PowerPack



Laptops



Tablets



Jump Starter PowerPack



Tablets



Plus more...



Mobile Phones



Portable Games



Portable DVD



Music Players



Mobile Phones



Portable Games



Digital Cameras



Music Players



DA1239 kit contents
Excludes DA1255



DA1238 kit contents



Raised Air Intakes

Other



If your likely to be driving your Land Rover in circumstances which could mean wading deep water or driving in very dusty conditions then you should consider fitting a raised air intake to your vehicle.

NRC6920

This version from Britpart is a classic mushroom-top snorkel for Defender. Featuring heavy-duty metal pipe work, cyclone pre-cleaner and a durable attractive matt black finish.

- DA2225 Defender - 300Tdi/Td5
- PHD500340 Defender - 2007 onwards
- NRC6920 Raised air intake cleaner for DA2225 & LR008383 Inside diameter - 64mm

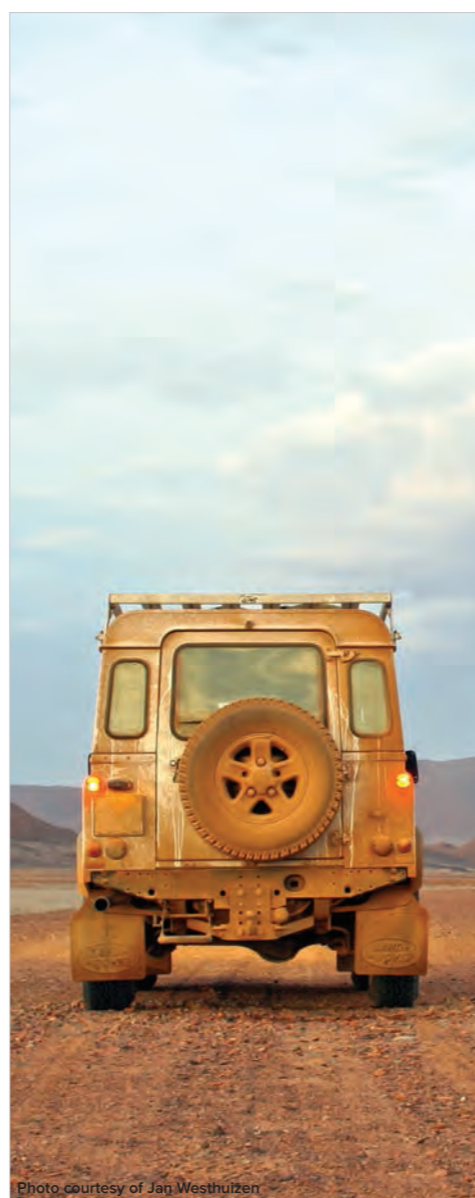

Photo courtesy of Jan Westhuizen

Safari

Pioneered in Australia in the early 1980's, Safari Snorkels were born out of a need to protect 4WD engines from the hazards of dust and water commonly encountered in touring and off road applications.

Safari snorkels are manufactured to the highest standards in durable, UV stable, cross linked polyethylene material, using stainless steel hardware where appropriate. Each system includes quality fixtures and fittings, which offer superior sealing, presentation and long-term durability.

In arguably the best, if not toughest environment, Safari Snorkel Systems are thoroughly researched, tested and tooled for each model of Land Rover. The Safari Snorkel delivers a continuous and cooler supply of air for maximum engine performance. It is positively sealed as well to ensure the best protection against deep water crossings and dust.



Model	Year Range	Snorkel fitment side
Discovery		
DA3015	Discovery 1 - 200Tdi - 1990 - 1994	LHS
DA3018	Discovery 1 - V8 - 1990 - 1994	LHS
DA3020	Discovery 1 - 300Tdi (non-EGR)	LHS
DA3022	Discovery 1 - V8 - 1994 - 1999 (non-ABS)	LHS
DA3025	Discovery 1 - 300Tdi (non-EGR)	LHS
DA3026	Discovery 1 - V8 - 1994 - 1999 (ABS)	LHS
DA3023	Discovery 2 - Td5	LHS
DA3021	Discovery 2 - V8 - 1999 onwards	LHS
DA3027	Discovery 3 - TdV6 SE/Discovery 4 - TdV6	RHS
DA2374	Stainless steel air ram grille. Shown attached to air ram - grille only. Will not fit DA3069 snorkel.	
DA3141	3" replacement air ram for DA3024	
DA3142	3 1/2" replacement air ram for DA3025, DA3026, DA3027, DA3027LH, DA3069	
Note	Fitment from seated internal view - RHS - right hand side and LHS - left hand side.	

Safari snorkels are manufactured to the highest standards in durable, UV stable, cross linked polyethylene material.

For more Safari Snorkel pictures visit - www.britpart.com/safari



DA3141 / DA3142



Photo courtesy of Natalie Moore



Winching Equipment

Never get stuck again with a Britpart Pulling Power electric winch and winching accessories. We've got everything you need to make sure that you don't get caught in a sticky situation and that you can recover yourself safely!

Batteries

Alternator upgrade kit	92
Battery charger	92
Dual battery management system	93
Optima	92
Replacement	92
Split charge relay	93

Britpart Winches

Winches	94 - 97
Winch spare parts	97

Tamper Proof Nuts & Bolts

.....	98
-------	----

Winch Bumpers

Winch bumper kits	98
Winch bumpers	99

Winching Accessories

Fairleads	100
Other essential winching accessories	101
Ropes & strops	100
Safety equipment	101
Shackles & pulleys	100
Winching accessory kits	101



Batteries

Optima Batteries

With its patented SpiralCell® Technology, Optima batteries offer 15 times the vibration resistance and up to twice the life of ordinary batteries. The Optima is like no other battery found in today's market. Optima's unique patented SpiralCell® design offers the best technology by providing a strong and clean power source that far surpasses any of today's traditional lead acid batteries. With Optima as your choice, you can count on a longer lasting battery.

Yellow Top

Demand more from your vehicle? Then get more from your battery. Optima Yellow Top batteries are made for the extremes. If your vehicle is designed to take the abuse of off-road driving, you need increased performance and reliability from your battery. Optima batteries combine patented SpiralCell® Technology to deliver that performance. The deep cycle characteristics of this technology coupled with its extreme resistance to vibration provides performance vehicles with the repetitive power they need, packaged in a spill-proof compact design.

If your vehicle is fitted with high drain accessories such as additional lighting, tracking devices, ICE systems, winches, hydraulics etc, then this ultimately demands more from your battery. Optima Yellow Top batteries provide the extra performance and deep cycling capability that your vehicle demands.

RedTop

Optima Red Top batteries are built to withstand the abuse 4x4's experience on and off-road. SpiralCell® Technology immobilises the internal components of the battery, enabling Optima batteries to withstand incredible amounts of vibration.

Vehicles modified for improved engine performance demand more from a battery. Optima batteries withstand the high engine bay temperatures associated with these performance vehicles. The sealed construction makes the battery spill-proof, even if you install it on its side!

This prevents external gassing and leaking which can damage engine components and reduce battery performance.

If your battery is used in applications that demand extra reliability endurance and performance, or if you just take pride in getting the best performance out of your vehicle, Optima Red Top batteries deliver the performance you demand.

Red Top Batteries

Voltage - 12v
Capacity - 50Ah
Cold Cranking Amps (CCA) - 815
DB1019 Top terminals
DB1021 Top & side terminals

Input voltage 220 - 240VAC, 50 - 60Hz

Output voltage 14.4V, 14.7V, 13.6V/Supply, 15.8V/Recond

Charging current 7A

Ripple Max 150mV rms, 0.3A

Ambient temperature -20°C to +50°C, output power is reduced automatically at higher temperatures

Charger type Eight step, fully automatic switch mode with pulse maintenance

Batteries 12V lead-acid batteries (Wet, MF, AGM, Calcium/Calcium and GEL)

Battery size 14 - 150Ah (14 - 225Ah maintenance charging)

Dimensions 191mm long x 89mm wide x 48mm high

Insulation IP 65

Weight 0.8kg



Supply mode allows the charger to be used as a power supply if you need to disconnect batteries from the vehicle. It is fully protected from producing voltages that can damage the vehicle's electronics. It is also non-sparking and features reverse polarity and short circuit protection.



Photo courtesy of Sebastien Fiastre

Replacement Batteries

- > Batteries are manufactured on the same equipment as OE batteries and use the same components to give consistent quality and performance.
- > Original equipment (OE) quality standards, giving assurance that the batteries will not let the user down.
- > Batteries are recyclable, helping to protect the environment.

	Capacity	CCA*
STC4757	70Ah	500
YGD500100	70Ah	640
LR038128	80Ah	770
LR072855 NEW	95Ah	855
LR033179	95Ah	855
LR030213	95Ah	855
LR038341	95Ah	855
LR077924 NEW	95Ah	855
YGD500130	95Ah	855
YGD100860	100Ah	1000mCA
STC8587	110Ah	750
YGD000271	110Ah	920

*Cold cranking amps



Alternator Upgrade Kits



200Tdi alternator upgrade kits. Kits include uprated cable.
DA1195 Defender - 200Tdi Upgrade the 45A alternator to 100A
DA1196 Discovery 1 - 200Tdi Upgrade the alternator to 100A

Microprocessor Controlled Dual Battery Management System



DA1174

This fully automatic Microprocessor Controlled Dual Battery Management System separates the starter battery from auxiliary battery if the vehicle has stopped and links them while the car is running. All systems are equipped with a 200A power relay. For emergency situations all systems are equipped with the manual override function (link). This manual linking function (called load sharing) is very helpful for jump starting or when using high current appliances such as an electrical recovery winch, power inverter or compressor. The kit includes a 4.7m wiring loom with sealed automotive plug, battery and crimp terminals for easy installation. The battery monitor is installed in the vehicle (dash) and informs the driver about the charge level of both batteries, the charging voltage from the alternator or an additionally installed solar system and the relay link status. The system offers low battery alarm on both batteries and a link failure alarm. Includes a manual link for 30 and 120 minutes with automatic return.

Functions

Display of Battery Voltage (Energy Level)

LED indicators:

- Green: Batteries are in the safe working range
- Yellow: Check batteries
- Red: Batteries should be charged

The LED's show the energy level if all loads are switched off:
12.6V = 100% / 12.4V = 75% / 12.2V = 50% / 12.0V = 25%
11.0V = flashing and beeping indicates low battery situation
This function is called by pressing the display button for about 30 seconds.

Display of Charge Voltage while charging

LED indicators:

- Red: >14.5V: High loading of batteries, may be present at cold ambient temp. for a longer time.
- Yellow: >14.0V: Proper charge mode.
- Green: <14.0V: Save charge mode, no damage to batteries.

Bi-directional Automatic Battery link

While the engine is running the main and auxiliary batteries are linked together for parallel charging from the alternator (green LED linked is on). If the engine is stopped, the two batteries will be disconnected automatically with some delay. Appliances such as fridges, lights, compressors, inverters are now safely fed from the auxiliary battery. With the additional charge by solar equipment, battery charger or generator is sufficient for charging, the starter battery will be charged automatically with auxiliary battery together (green LED "link" lights).

Manual Battery "link"

In an emergency situation (defective or empty main battery) or in case of higher power consumption the two batteries (main & auxiliary) may be connected together by activating the link button (red LED manually linked is on). After a lapse of time of 30 minutes (or immediately after activating the auto button), the system returns to the automatic mode. When using an electric winch, the battery connection can be activated for 120 minutes by pressing the link button twice. In this mode sounds a beep every 30 seconds to remind of this status (auto return after time expired). The load sharing function with the manual battery connection reduces the load on the alternator, the wiring and the batteries in the use of the winch.

Alarm functions:

Low battery alarm

If the battery voltage of one or both of the batteries, is for a longer period below 12V, the sound low battery with "Beep" and the LED "Low Battery" of the corresponding battery (main and / or auxiliary) flashes. With the display button, the "Beep" is switched off. The blinking LED "Low Battery" is reset if the battery voltage is exceeding 12V.
Link failure alarm

The monitor monitors the charge on both batteries. When fitting charge (from alternator, solar, charger) no charge to the other battery is detected, the link error alarm with flashing green LED "linked" and the "Beep" sounds. If this error occurs, check immediately the wiring of the power cables to (relay, battery terminals, crimp contacts, control relays). After bug fixes, alarm will automatically reset.

Deactivation of automatic and manual battery dual link function

Is there a problem with the auxiliary battery (aux) as short circuit of cells, short circuit or defective battery housing, leading to damage of the generator (alternator). In an emergency situation the battery system can be operated in the vehicle in the basic configuration (alternator, starter battery without additional charge to auxiliary battery). By pressing the link button for 6 seconds (until the sound of the beep), the link is deactivated. In this mode, no manual and automatic battery connection is possible. This feature can solve the battery problem of the auxiliary battery by pressing the auto button for 6 seconds to be reset. Now the system is working again with all the functions.

Winch application

Connect an electrical recovery winch to the main battery as shown in the wiring diagram.

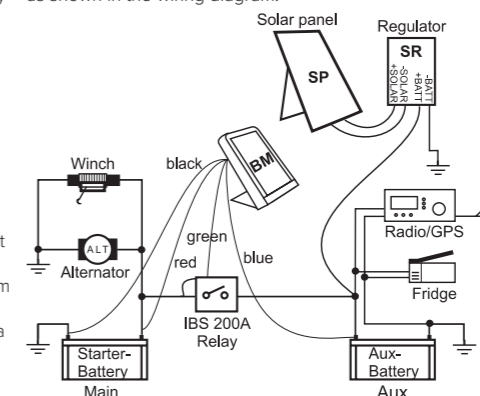

Specifications

Supply voltage 4 - 16V
System voltage 12V
Measuring range (sense wire blue) 8 - 16V
Display range (battery voltage) 11.0V - 12.8V
Alarm level main and aux 12.0V
Display range (charge) 13.0V - 14.5V
Accuracy +/-1%
Consumption monitor 1mA
Consumption max. display active (30 sec) 20mA
Isolator link-on/off threshold 13.1V/13.0V
Consumption on-state (relay) 0.6A
Relay continuous load current 200A
Relay current inrush 500A
Relay contact material Silver (AG SnO2)
Free combination of batteries possible? Yes
Operating temperature -40°C - +80°C
Housing ABS black
Sealing level IP40
Size, dimensions 100 x 65 x 24mm
Weight 800g
Cabling

Red - Supply/sense (main battery)
Black - GND (main battery)
Blue - Sense (aux battery)
Green - Control relay (open collector)

Protected against

Wrong polarity & against overload of solenoid driving circuit on PC board with SMD electronically security devices, no fuses have to be replaced.

Kit contents -



Mounting Options

- DA1174GM Mounting plate with flexible arm
- DA1174SM Mounting plate with swivel mount
- DA1174HM Mounting plate with swivel arm



Split Charge Relay



DB1500 NEW Heavy-duty 200A split charger

Winches



BRITPART
PULLING POWER

If you are serious about off-roading then a winch is an essential piece of kit. They are indispensable when getting yourself and others out of tricky situations.

The Britpart Pulling Power range of powerful and reliable electric winches all feature a planetary gear system for fast line speed, free spooling, power in & power out and low electric current. Now with the larger winches you have a choice of having the traditional steel cable fitted or Dyneema rope.

A full range of winching equipment is also available from Britpart - including; safety gear, bumpers, chocks, hooks, shackles & ropes.

Together with the winches you'll be able to **'Get to where you want to go!'**

24 month
Guarantee
BRITPART on all Britpart Winches

Features	DB12000i	DB9500i	DB9000C	DB8000	DB6000	DB2000
Motors	3.6Kw (4.8Hp) Heavy-duty series wound DC motor	3.6Kw (4.8Hp) Heavy-duty series wound DC motor	3.3Kw (4.5Hp) Permanent magnetic DC motor	3.0Kw (4.1Hp) Permanent magnetic DC motor	2.7Kw (3.6Hp) Permanent magnetic DC motor	1.0Kw (1.5Hp) Permanent magnetic DC motor
Models available	12 volts & 24 volts	12 volts & 24 volts	12 volts	12 volts	12 volts	12 volts
Steel cable or Dyneema rope	Steel cable or Dyneema rope	Steel cable or Dyneema rope	Steel cable or Dyneema rope	Steel cable	Steel cable	Steel cable
Weather & dustproof contactor controls	✓	✓	✓	✓	✓	
Planetary gear system for fast line speed	✓	✓	✓	✓	✓	✓
Automatic load holding brake	✓	✓	✓	✓	✓	
Free spooling	✓	✓	✓	✓	✓	✓
Power in & power out	✓	✓	✓	✓	✓	✓
Low electric current	✓	✓	✓	✓	✓	✓
Hardened drum	✓	✓	✓	✓		
Specifications						
Rated line pull - single line	5,443kgs 12,000lbs	4,309kgs 9,500lbs	4,082kgs 9,000lbs	3,632kgs 8,000lbs	2,722kgs 6,000lbs	907kgs 2,000lbs
Gear reduction ratio	294:1	212:1	212:1	210:1	210:1	153:1
Motor size	3.6Kw 4.8Hp	3.6Kw 4.8Hp	3.3Kw 4.5Hp	3.0Kw 4.1Hp	2.7Kw 3.6Hp	1.0Kw 1.5Hp
Drum size - D x L	67 x 228mm 2.64 x 9"	67 x 228mm 2.64 x 9"	63 x 228mm 2.5 x 9"	63 x 228mm 2.5 x 9"	63 x 140mm 2.5 x 5.51"	32 x 71mm 1.26 x 2.8"
Steel cable - size	9.53mm x 30.5m 0.38" x 100'	9.53mm x 30.5m 0.38" x 100'	9.53mm x 30.5m 0.38" x 100'	9.53mm x 30.5m 0.38" x 100'	7.94mm x 26m 0.31" x 85'	4mm x 15.2m 0.16" x 50'
Dyneema rope - size	11mm x 28m 0.43" x 91.9'	11mm x 28m 0.43" x 91.9'	11mm x 28m 0.43" x 91.9'	N/A	N/A	N/A
Overall dimensions - L x W x H	548 x 167 x 299mm 21.57 x 6.57 x 11.77"	548 x 167 x 299mm 21.57 x 6.57 x 11.77"	560 x 160 x 280mm 22.0 x 6.3 x 11.0"	570 x 180 x 280mm 22.4 x 7.0 x 11.0"	438 x 158 x 185mm 17.24 x 6.22 x 7.28"	320 x 105 x 111mm 12.6 x 4.13 x 4.35"
Steel cable - net weight	43.0kgs 94.8lbs	43.0kgs 94.8lbs	38.0kgs 84.0lbs	36.0kgs 80.0lbs	31.8kgs 70.0lbs	6.6kgs 14.6lbs
Dyneema rope - net weight	33.0kgs 72.8lbs	33.0kgs 72.8lbs	31.0kgs 68.3lbs	N/A	N/A	N/A
Mounting bolt pattern	254 x 114.3mm 10 x 4.5"	254 x 114.3mm 10 x 4.5"	254 x 114.3mm 10 x 4.5"	254 x 114.3mm 10 x 4.5"	166 x 114.3mm 6.54 x 4.5"	48 x 76mm 1.89 x 3.0"

Winches - continued

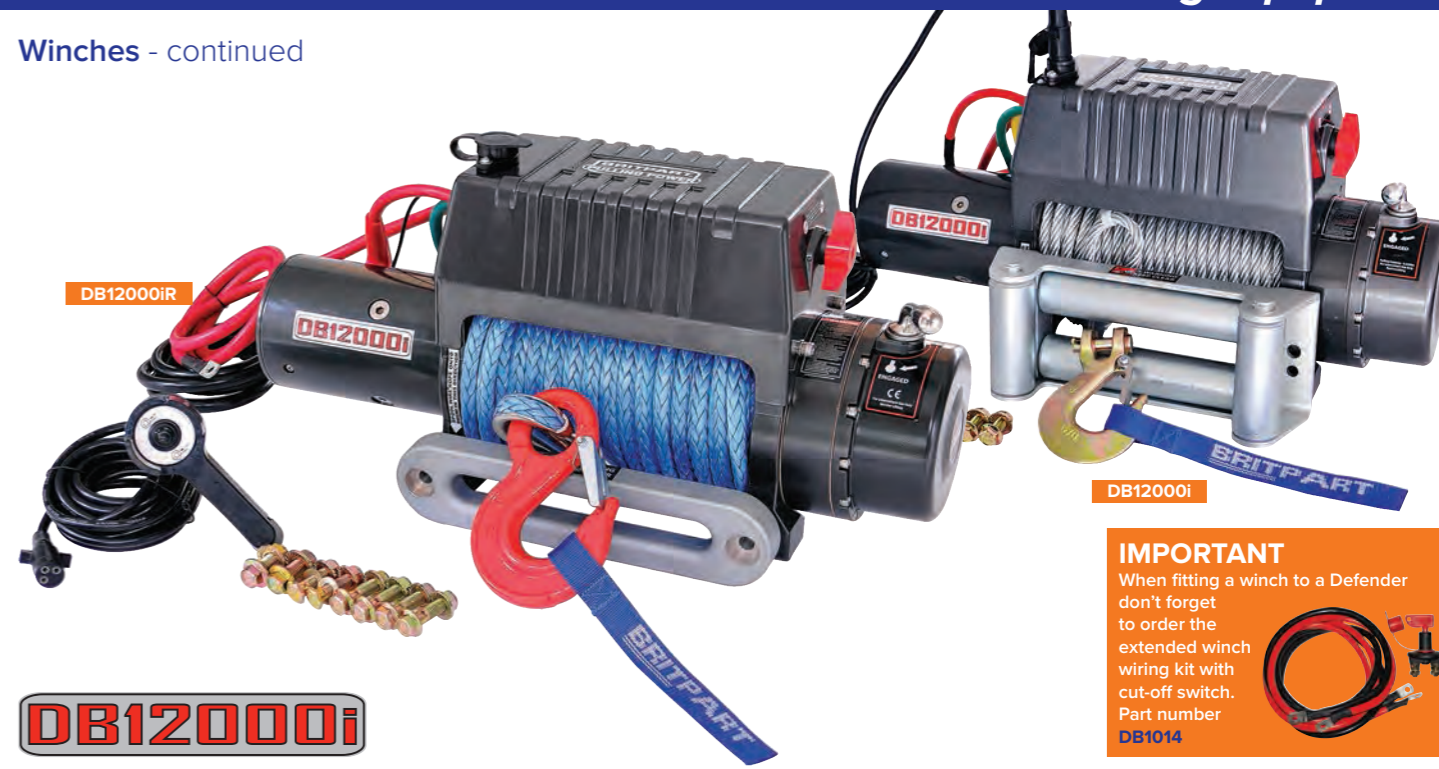

DB12000i

Performance of 1st Layer								Line Pull & Cable/Rope Capacity by Layer							
Line Pull		Line Speed				Motor Current		Rope Layer	Rated Line Pull		Rope Capacity				
		12 volt		24 volt		12 volt	24 volt				Steel Cable		Dyneema Rope		
Lbs	Kg	Fpm	Mpm	Fpm	Mpm	Amp	Amp	Lbs	Kg	Feet	Meters	Feet	Mtrs		
0	0	14.0	4.2	16.8	5.1	90	68								
4,000	1,816	9.2	2.8	11.3	3.5	190	140	1	12,000	5,448	15.0	5.0	13.8	4.2	
6,000	2,724	7.9	2.4	9.5	2.9	230	165	2	10,200	4,631	38.0	11.5	31.2	9.5	
8,000	3,632	6.9	2.1	8.4	2.5	260	190	3	8,400	3,814	64.0	19.5	51.5	15.7	
10,000	4,540	6.5	2.0	7.8	2.4	300	220	4	7,300	3,314	95.0	29.0	76.4	23.3	
12,000	5,448	5.9	1.8	7.0	2.2	330	245	5	6,500	2,950	100.0	30.5	91.9	28.0	

IMPORTANT
When fitting a winch to a Defender don't forget to order the extended winch wiring kit with cut-off switch.
Part number DB1014

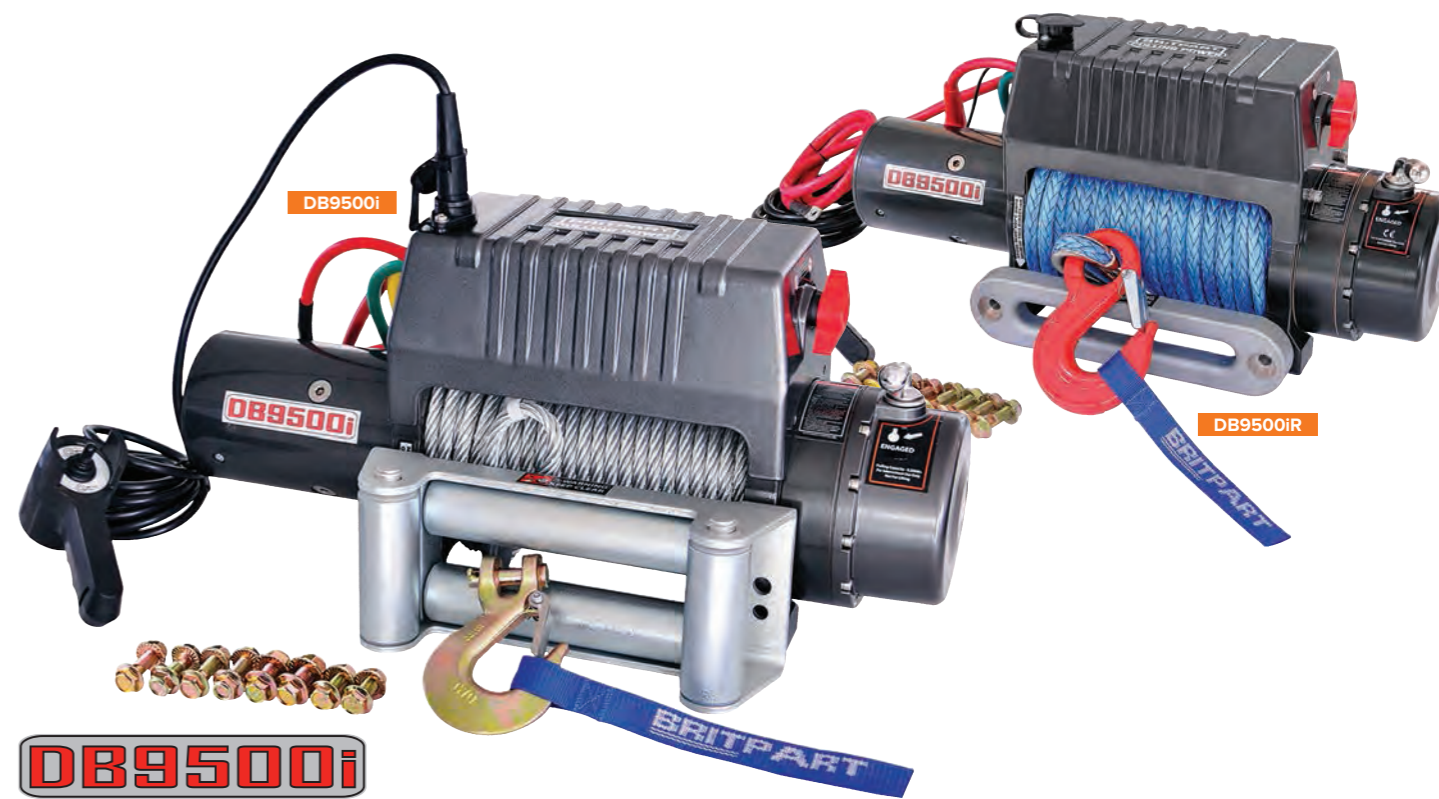

DB9500i

Performance of 1st Layer								Line Pull & Cable/Rope Capacity by Layer							
Line Pull		Line Speed				Motor Current		Rope Layer	Rated Line Pull		Rope Capacity				
		12 volt		24 volt		12 volt	24 volt				Steel Cable		Dyneema Rope		
Lbs	Kg	Fpm	Mpm	Fpm	Mpm	Amp	Amp	Lbs	Kg	Feet	Meters	Feet	Mtrs		
0	0	19.0	5.8	22.5	6.9	110	85								
4,000	1,816	12.5	3.8	14.8	4.5	210	145	1	9,500	4,309	15.0	5.0	13.8	4.2	
6,000	2,724	10.5	3.2	12.5	3.8	260	190	2	7,500	3,402	38.0	11.5	31.2	9.5	
8,000	3,632	8.6	2.6	10.5	3.2	300	220	3	6,200	2,812	64.0	19.5	51.5	15.7	
9,500	4,313	7.9	2.4	9.2	2.8	350	275	4	5,300	2,404	95.0	29.0	76.4	23.3	
								5	4,630	2,100	100.0	30.5	91.9	28.0	

Galvanised aircraft cable with break force - 14,400lbs
DB9500i
Britpart 9,500lbs winch 12 volt
DB9500i24
Britpart 9,500lbs winch 24 volt

Dyneema rope with break force - 25,800lbs
DB9500iR
Britpart 9,500lbs winch 12 volt

Winches - continued



DB9000C

Performance of 1st Layer					Line Pull & Cable/Rope Capacity by Layer					
Line Pull		Line Speed		Motor Current	Rope Layer	Rated Line Pull		Rope Capacity		
Lbs	Kg	Fpm	Mpm	Amp		Lbs	Kg	Steel Cable Feet	Dyneema Rope Meters	
0	0	9.8	3.0	50	1	9,000	4,309	15.0	5.0	
2,000	907	9.8	3.0	120		7,500	3,402	38.0	11.5	
4,000	1,814	8.9	2.7	170		6,200	2,812	64.0	19.5	
6,000	2,722	8.2	2.5	225		5,300	2,404	95.0	29.0	
8,000	3,629	7.2	2.2	275		4,630	2,100	100.0	30.5	
9,000	4,086	6.1	1.9	300						

Galvanised aircraft cable with break force - 14,400lbs
DB9000C
 Britpart 9,000lbs winch 12 volt

Dyneema rope with break force - 25,800lbs
DB9000CR
 Britpart 9,000lbs winch 12 volt

Winches - continued



DB2000



Britpart DB2000 fitted to a working model of a Land Rover

Performance of 1st Layer					Line Pull & Rope Capacity by Layer					
Line Pull		Line Speed		Motor Current	Rope Layer	Rated Line Pull		Rope Capacity		
Lbs	Kg	Fpm	Mpm	Amp		Lbs	Kg	Steel Cable Feet	Mtrs	
0	0	14.0	4.3	14	1	2,000	907	6.0	1.8	
1,000	454	9.0	2.7	60		1,636	742	13.0	4.0	
1,500	680	7.5	2.3	90		1,385	628	22.0	6.7	
2,000	907	5.9	1.8	115		1,200	544	33.0	10.0	
						1,059	480	44.0	13.4	
						947	430	50.0	15.2	

Cable with break force - 4,000lbs
DB2000
 Britpart 2,000lbs winch 12 volt
 Includes tension plate to prevent rope entanglement

Important
 Winch suitable for small vehicles and trailer applications only.



DB8000

Performance of 1st Layer					Line Pull & Cable Capacity by Layer					
Line Pull		Line Speed		Motor Current	Rope Layer	Rated Line Pull		Rope Capacity		
Lbs	Kg	Fpm	Mpm	Amp		Lbs	Kg	Feet	Mtrs	
0	0	8.2	2.5	35	1	8,000	3,620	15.0	5.0	
2,000	900	7.8	2.4	100		6,335	2,876	38.0	11.5	
4,000	1,810	7.2	2.2	180		5,243	2,380	64.0	19.5	
6,000	2,710	6.5	2.0	230		4,473	2,030	95.0	29.0	
8,000	3,620	5.0	1.5	300		3,900	1,770	100.0	30.5	

IMPORTANT
 When fitting a winch to a Defender don't forget to order the extended winch wiring kit with cut-off switch. Part number **DB1014**

Galvanised aircraft cable with break force - 14,400lbs
DB8000
 Britpart 8,000lbs winch 12 volt

DB6000

Performance of 1st Layer					Line Pull & Cable Capacity by Layer					
Line Pull		Line Speed		Motor Current	Rope Layer	Rated Line Pull		Rope Capacity		
Lbs	Kg	Fpm	Mpm	Amp		Lbs	Kg	Feet	Mtrs	
0	0	15.0	4.6	30	1	6,000	2,722	12.7	3.9	
1,000	454	11.5	3.5	80		5,000	2,268	27.5	8.4	
3,000	1,361	9.0	2.7	120		4,250	1,928	44.0	13.4	
5,000	2,268	7.0	2.0	170		3,720	1,687	64.0	19.5	
6,000	2,722	4.9	1.5	210		3,300	1,497	85.0	25.9	

Galvanised aircraft cable with break force - 10,000lbs
DB6000
 Britpart 6,000lbs winch 12 volt

Winch Spare Parts

	DB12000i	DB9500i	DB9000C	DB8000	DB6000	DB2000
Winch motor	DB1300	DB1300	DB1332	DB1301	DB1337	N/A
Solenoid assembly	DB1303	DB1303	DB1302	DB1302	DB1336	N/A
Brake service kit	DB1304	DB1304	DB1304	N/A	DB1338	N/A
Roller fairlead	DB1307 180mm aperture	DB1307 180mm aperture	DB1307 180mm aperture	DB1307 180mm aperture	DB1341 105mm aperture	N/A
Winch cable	DB1328	DB1328	DB1328	DB1328	DB1339	DB1354 Winch cable & hook
Winch cable hook	DB1328H	DB1328H	DB1328H	DB1328H	N/A	
Brush & holder set	DB1330	DB1330	DB1331	DB1331	DB1340	N/A
Remote control	DB1327 - rocker switch DB1334 - toggle switch	DB1327 - rocker switch DB1334 - toggle switch	DB1327 - rocker switch DB1334 - toggle switch	DB1327 - rocker switch DB1334 - toggle switch	DB1334	DB1343
Remote control socket upgrade kit From 15mm to 20mm with remote control.	DB1352	DB1352	DB1352	DB1352	DB1352	N/A
Remote control socket upgrade/repair From 15mm to 20mm	DB1352R Can also be used to repair existing 20mm socket	DB1352R Can also be used to repair existing 20mm socket	DB1352R Can also be used to repair existing 20mm socket	DB1352R Can also be used to repair existing 20mm socket	DB1352R Can also be used to repair existing 20mm socket	N/A



For more images of the winch spare parts - www.britpart.com/wincharts

Winch Bumpers

Winch Bumper Kits



Britpart have all the kits you need to help you to get winching.

Defender winch bumper kits all include the extended wiring kit including safety cut-off switch kit (DB1014)

Standard Bumper

DB1313	Defender - non air-con	Steel Cable	DB12000i winch
DB1313R	Defender - non air-con	Dyneema Rope	DB12000i winch
DB1344	Defender - air-con	Steel Cable	DB12000i winch
DB1344R	Defender - air-con	Dyneema Rope	DB12000i winch
DB1310	Defender - non air-con	Steel Cable	DB9500i winch
DB1310R	Defender - non air-con	Dyneema Rope	DB9500i winch
DB1345	Defender - air-con	Steel Cable	DB9500i winch
DB1345R	Defender - air-con	Dyneema Rope	DB9500i winch
DB1313-24V	Defender - non air-con	Steel Cable	DB12000i winch - 24 volt
DB1325	Discovery 1/Range Rover Classic	Steel Cable	DB12000i winch
DB1325R	Discovery 1/Range Rover Classic	Dyneema Rope	DB12000i winch
DB1324	Discovery 1/Range Rover Classic	Steel Cable	DB9500i winch
DB1324R	Discovery 1/Range Rover Classic	Dyneema Rope	DB9500i winch
Note - DB1324, DB1325, DB1324R & DB1325R are for vehicles without air-con and/or without transmission oil coolers fitted.			
DB1346	Discovery 2	Steel Cable	DB12000i winch
DB1346R	Discovery 2	Dyneema Rope	DB12000i winch
DB1347	Discovery 2	Steel Cable	DB9500i winch
DB1347R	Discovery 2	Dyneema Rope	DB9500i winch

Galvanised Standard Bumper

DB1313GALV	Defender - non air-con	Steel Cable	DB12000i winch
DB1313RGALV	Defender - non air-con	Dyneema Rope	DB12000i winch
DB1310GALV	Defender - non air-con	Steel Cable	DB9500i winch
DB1310RGALV	Defender - non air-con	Dyneema Rope	DB9500i winch

Tubular Bumper

DB1319	Defender - non air-con	Steel Cable	DB12000i winch
DB1319R	Defender - non air-con	Dyneema Rope	DB12000i winch
DB1321	Defender - air-con	Steel Cable	DB12000i winch
DB1321R	Defender - air-con	Dyneema Rope	DB12000i winch
DB1348	Defender - non air-con	Steel Cable	DB9500i winch
DB1348R	Defender - non air-con	Dyneema Rope	DB9500i winch
DB1349	Defender - air-con	Steel Cable	DB9500i winch
DB1349R	Defender - air-con	Dyneema Rope	DB9500i winch
DB1320	Discovery 1	Steel Cable	DB12000i winch
DB1320R	Discovery 1	Dyneema Rope	DB12000i winch
DB1350	Discovery 1	Steel Cable	DB9500i winch
DB1350R	Discovery 1	Dyneema Rope	DB9500i winch
Note - DB1320, DB1350, DB1320R & DB1350R the grille needs trimming for fitting to air-con & automatic vehicles.			

Standard Bumper



Standard Galvanised Bumper



Tubular Bumper

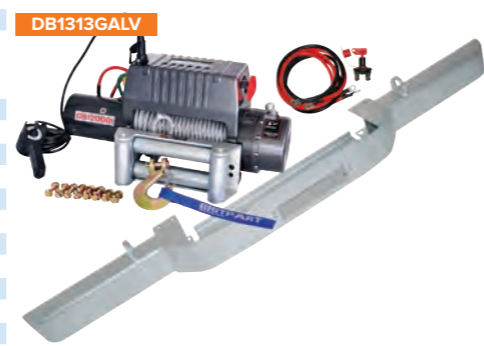

Tamper Proof Nuts & Bolts



Ensure your precious accessories remain firmly on your Land Rover by using a set of these tamper proof nuts and bolts. Ideal for securing your winch and front bumper. Each set contains either 4 nuts or bolts and 1 key.

- DA7330 NEW M6 nut set & key
- DA7331 NEW M8 nut set & key
- DA7332 NEW M10 nut set & key
- DA7333 NEW M10 x 110 bolt set & key
- DA7334 NEW M10 x 35 bolt set & key



Winch Bumpers

Tubular winch bumpers

- > Stylish tubular steel space-frame construction for strength
 - > Extremely close fitting for maximum approach angle
 - > Compatible with many steering guards
 - > Built-in high-lift jacking points
 - > Integral rock guard
 - > Supplied with full fitting kit
- Note** - Grille will need modifying
- DA5609** Defender - air-con
Suitable for DB12000i, DB9500i, DB9000C & DB8000 winches
- DA5622** Defender - non air-con
Suitable for DB12000i, DB9500i, DB9000C & DB8000 winches
- DA5604** Discovery 1
Suitable for DB12000i, DB9500i, DB9000C & DB8000 winches
- Note** - Grille needs trimming for fitment to air-con & automatic vehicles

Standard winch bumpers

- > Heavy-duty steel winch bumpers
- DA5620** Defender - non air-con Black
Suitable for DB12000i, DB9500i, DB9000C & DB8000 winches
- DA5681** Defender - non air-con Galvanised
Suitable for DB12000i, DB9500i, DB9000C & DB8000 winches
- DA5623** Defender - air-con
Suitable for DB12000i, DB9500i, DB9000C & DB8000 winches
- DA5643** Defender - air-con
Suitable for Warn 9000 and 9.5 Series winches
- DA5621** Discovery 1/Range Rover Classic
Note - For vehicles without air-con and/or without transmission oil coolers fitted
Suitable for DB12000i, DB9500i, DB9000C & DB8000 winches
- DA5645** Discovery 2
> One piece bumper manufactured from 5mm steel with wrap around sides to protect the wings
> Fixed to standard mounting points with provisions for 2 swivel recovery points and 2 Hi-Lift jacking points
Note - Grille needs trimming to fit winch
Suitable for DB12000i, DB9500i, DB9000C & DB8000 winches

A range of winch bumpers to suit your Land Rover

Discreet winch bumpers

- > Suitable for any low line winch
 - > Made from 6mm and 8mm steel
 - > Discreetly fits behind the existing bumper
 - > Bolts directly onto the front cross member using existing holes
 - > Modifications to bumper are required, includes instructions
 - > Excludes fairlead
- Note** - Low line winch needs to have a removable solenoid. Use DB8000 or DB9000 - solenoid needs to be removed and relocated.
- DA7537** Discovery 3 - TdV6/Discovery 4 - TdV6/Range Rover Sport - TdV6
- DA7538** Range Rover Sport - 3.6 TdV8, 4.2 V8 Supercharged, 4.4 V8



Defender Bumper Fitting Kits

- DA1171K NEW**
Easier fitment plates which replace the standard fitted spring clip plates. With stainless steel bolt set.
- DA1171**
Easier fitment plates which replace the standard fitted spring clip plates. Without bolt set.
- ALQ710020K NEW**
Tapping blocks & stainless steel bolt set
- DA1269 NEW**
Tapping blocks & bumper bolt kit
- DA1268 NEW**
Bumper bolt kit
- DA5621K**
Discovery 1/Range Rover Classic Replacement fitting kit for winch bumper - DA5621

Number Plate Bracket

- DA5699**
Universal number plate mounting bracket 405mm wide x 110mm deep. Number plate not included.

Winch Accessories

Fairleads



255mm Mounting holes			
DB1003	Hawse fairlead	Steel	215mm aperture
DB1004	Hawse fairlead	Steel	130mm aperture
DB1315	Hawse fairlead	Aluminium	205mm aperture
DB1317	Hawse fairlead	Stainless steel	205mm aperture
DB1316	Roller fairlead	Stainless steel	180mm aperture
DB1307	Roller fairlead	Zinc coated	180mm aperture
DB1341	Roller fairlead	Zinc coated	105mm aperture
125mm Mounting holes			
DB1005	Hawse fairlead	Steel	80mm aperture



Ropes & Strops



DA3032	Tree strop	1.5t SP	3m x 90mm
DA3033	Tree strop	1.5t SP	4m x 90mm
DA3034	Tree strop	1.5t SP	6m x 90mm
DB1007	Tree strop	4t SP	1.6m x 120mm
DA2246	Tow strap	2t WLL	5m x 60mm
DB1006	Tow strap	8t WLL	9m x 60mm
DB1011	High elasticity tow sling	8t WLL	9m x 60mm
DA3028	Rope - polypropylene	8t MBL	5m x 24mm
DA3029	Rope - nylon	12t MBL	5m x 24mm
DA3030	Kinetic recovery rope - octoplat	12t MBL	5m x 24mm
DA3031	Kinetic recovery rope - octoplat	12t MBL	8m x 24mm



Shackles & Pulleys



DA3160	Swivel recovery eye - stainless steel - 36mm diameter & shackle (3.25 tons)
Note - Not suitable for standard Land Rover bumpers	
DA3160A	Replacement shackle for DA3160
DB1009	Shackle - 1.4 ton
DB1353	'D' shackle - 1.4 ton
DB1012	Shackle - 4.7 ton
DB1322	Swivel shackle
DB1323	Non-forged jate ring
DB1329	Forged jate ring
DB1008	Pulley hook - SWL loads - Pulling - 1,500kgs / Lifting - 750kgs
DB1002	Snatch block
High quality tempered steel. Maximum head load - 9,000kgs.	



DA7335 NEW
 Dynaline Shackle Pair
 Minimum breaking load - 5,830kg
 Weight - 40g each
 Manufactured from 8mm Dyneema SK78 fibre.
 The lightweight, easy and safe way of joining ropes and strops. Due to the much lower kinetic energy being stored, using this Dynaline shackle is much safer in the event of a rope or strop failure. Can also be used to attach ropes to standard towing eyes without scratching the paintwork. See how easy it is to use this shackle at - www.britpart.com/DA7335

More product images at www.britpart.com

Winching Accessory Kits



Britpart Pulling Power winching recovery kits come with all the basic items needed to ensure your winch can be used to the best effect. There is a choice of a starter or professional kit depending on your needs.

- DB1015**
 1 x DB1000 Wheel chocks (pair)
 1 x DB1001 Winch kit bag
 1 x DB1002 Snatch block - 9,000kgs
 1 x DB1006 Tow strap - 8 ton, 60mm x 9m
 1 x DB1007 Tree strop
 1 x DB1010 Winching gloves
 1 x DB1011 Snatch tow sling - 8 ton
 2 x DB1012 Alloy bow shackle - 4.75 ton
 1 x DB1016 Winching blanket

- DB1017**
 1 x DB1001 Winch kit bag
 1 x DB1002 Snatch block - 9,000kgs
 1 x DB1006 Tow strap - 8 ton, 60mm x 9m
 1 x DB1007 Tree strop
 1 x DB1010 Winching gloves
 2 x DB1012 Alloy bow shackle - 4.75 ton

- DB1017P**
 1 x DB1001 Winch kit bag
 1 x DB1002 Snatch block - 9,000kgs
 1 x DB1007 Tree strop
 1 x DB1010 Winching gloves
 2 x DB1012 Alloy bow shackle - 4.75 ton
 2 x DB1329 Jate rings

Safety Equipment

DA2037	Universal battery isolator switch
DA2037KY	Replacement isolator switch key for DA2037
DA3156	Winch In Safety - A5 guide from Land Rover
DB1000	Wheel chocks - pair
DB1010	Gloves - for protection winch operation
DB1016	Winch blanket - manufactured from heavy-duty vinyl, the blanket will absorb most of the recoil in the unlikely event of the cable breaking. It's also very useful to kneel on in the mud!

Winch remote control
DB1308 12 volt remote
DB1308-24V 24 volt remote
 Operate your winch from a safe distance with this wireless remote control
 > High frequency circuit using SMD design for reliability
 > The transmitter uses FM technology for frequency stability and greater control distance
 > Receiver output is protected against voltage spikes



Winch with safety in mind



Other Essential Winching Accessories

DB1309 'Dyneema Bowrope'
 12 strand synthetic fibre replacement winch rope - 11mm x 28m
 Breaking point - 25,800lbs
 > For use with DB9000C, DB9500i and DB12000i winches
 > Very light > Very strong > Easy to handle
 > Easily spliced > Does not curl > Floats
 > Highly visible > Compact > Does not kink
 > Less effort in use > Safety in use

DB1328 Replacement winch cable with hook - 30.5m x 9.5mm
 Galvanised aircraft cable with break force - 14,400lbs
DB1001 Winch bag - a heavy-duty bag
DB1014 Extended winch wiring kit - 1 x red, 1 x black wire, each 1.8m in length with end connectors and cut-off switch for Defender vehicles

DA6541 NEW Pull yourself out of trouble with this heavy-duty ground anchor. This anchor utilises a Hi-Lift jack (not included).

DB1314 Ground anchor set - 600mm pins
DB1318 Ground anchor bag set - 2 x Pulling Power bags
Note - ground anchor not included (DA1314)





Oops!...
 “Glad I’ve got that Britpart winch”

Performance Equipment

Make your Land Rover even more special by upgrading from its standard spec to something a bit more unique. An extensive selection of braking equipment to air filters and tuning boxes means that there is something to suit every Land Rover to help improve its performance.

Braking

Anti-squeal shims	104
Brake discs - Britpart Performance	104
Brake discs - EBC	105
Brake hose kits	107
Brake lubrication	104
Brake pads - DTEC	107
Brake pads - EBC	105 - 106
Handbrake conversion kits	108

Engine

Air filters - Britpart Performance	110
Air filters - K&N	111
Aluminium header tanks	112
EGR blanking & silicone hose kits	109
EGR blanking kits & tubes	108
Electric fan kits	113
Filter guards	109
Intercoolers - performance	111
PSI power tuning products	114
Silicone hose kits	112
Tuning box	114
Tunit	114
Turbo boost box	115
Upgrade chips	114
Weber carburettors	115

Exhausts

Double 'S' stainless steel exhausts	116 - 117
Exhaust fitting kits	116
Front down pipes	115
Stainless steel exhaust	115
Utility link pipes & rear silencers	117



Braking

Britpart Performance Brake Discs



- > Slotted design to increase braking efficiency by reducing dust, debris, water and gas on the disc.
- > To improve brake cooling, reduce weight and to offer an escape route for dirt and gasses these performance discs are drilled with rows of holes.
- > Excellent upgrade for your Land Rover to aid braking, especially under a heavy load.
- > Ideal for off-road use.
- > Manufactured to British Standard BS1452 Grade 220 and DIN1691 GG20.
- > Supplied in pairs.

Quality performance brake discs.

IMPORTANT BRAKE INFORMATION

For exact change over points with vehicle applications please contact your local Britpart distributor with the full chassis number for the correct application. These references are intended as a guide only.

Defender	Corresponds to			
DA4600	LR017951/FRC7329	Defender - 1987 - 2006 & 2007 onwards	Front	Solid
DA4602	LR017952/FTC902	Defender - 1987 - 2006 & 2007 onwards	Front	Vented
DA4601	LR017953/FTC1381	Defender - 1987 - 2006 & 2007 onwards	Rear	Solid
DA4605	LR018026/SDB000330	Defender - 1987 - 2006 & 2007 onwards	Rear	Solid

Discovery				
DA4600	LR017951/FRC7329	Discovery 1	Front	Solid
DA4602	LR017952/FTC902	Discovery 1	Front	Vented
DA4601	LR017953/FTC1381	Discovery 1	Rear	Solid
DA4606	SDB000380	Discovery 2	Front	Vented
DA4604	SDB000470	Discovery 2	Rear	Solid
DA4611	SDB000614	Discovery 3	Front	Vented
DA4612	SDB000604	Discovery 3	Front	Vented
DA4613	SDB000646	Discovery 3	Rear	Vented
DA4614	SDB000636	Discovery 3	Rear	Vented
DA4624	SDB000624	Discovery 4	Front	Vented
DA4612	SDB000604	Discovery 4	Front	Vented
DA4613	SDB000646	Discovery 4	Rear	Vented
DA4614	SDB000636	Discovery 4	Rear	Vented
DA4689 NEW	LR059122	Discovery Sport	Front	Vented
DA4690 NEW	LR061388	Discovery Sport	Rear	Solid

Freelander				
DA4607	SDB100830	Freelander 1 - up to YA999999	Front	Solid
DA4608	SDB101070	Freelander 1 - 1A000001 onwards	Front	Vented
DA4617	LR000470/LR027107	Freelander 2 - petrol	Front	Vented
DA4615	LR001019	Freelander 2 - petrol	Rear	Vented
DA4618	LR007055	Freelander 2 - diesel	Front	Vented
DA4616	LR001018	Freelander 2 - diesel	Rear	Solid
DA4688 NEW	LR039935	Freelander 2	Rear	Solid

Range Rover				
DA4600	LR017951/FRC7329	Range Rover Classic - 1986 - 1991	Front	Solid
DA4602	LR017952/FTC902	Range Rover Classic - 1986 - 1994	Front	Vented
DA4601	LR017953/FTC1381	Range Rover Classic - 1986 - 1994	Rear	Solid
DA4603	NTC8780	Range Rover P38 - 1995 - 2002	Front	Vented
DA4604	SDB000470	Range Rover P38 - 1995 - 2002	Rear	Solid
DA4611	SDB000614	Range Rover Sport - 2005 - 2009	Front	Vented
DA4612	SDB000604	Range Rover Sport - 2005 - 2009	Front	Vented
DA4624	SDB000624	Range Rover Sport - 2005 - 2013	Front	Vented
DA4613	SDB000646	Range Rover Sport - 2005 - 2013	Rear	Vented
DA4614	SDB000636	Range Rover Sport - 2005 - 2009	Rear	Vented
DA4628 NEW	LR016192	Range Rover Sport - 2010 - 2013	Rear	Vented
DA4627	LR016176	Range Rover Sport - 2014 onwards	Front	Vented
DA4685 NEW	LR038934	Range Rover Sport - 2014 onwards	Front	Vented
DA4686 NEW	LR033303	Range Rover Sport - 2014 onwards	Rear	Vented
DA4687 NEW	LR033302	Range Rover Sport - 2014 onwards	Rear	Vented
DA4609	SDB000201	Range Rover L322	Front	Vented
DA4619	SDB500182	Range Rover L322	Front	Vented
DA4622	LR031843/SDB500193	Range Rover L322	Front	Vented
DA4610	SDB000211	Range Rover L322	Rear	Solid
DA4623	LR017804/LR031844/SDB500202/SDB500201	Range Rover L322	Rear	Vented
DA4625	LR011591	Range Rover L322 - 2010 - 2012	Front	Vented
DA4627	LR016176	Range Rover L322 - 2010 - 2012	Front	Vented
DA4626	LR011891/LR031846	Range Rover L322 - 2010 - 2012	Rear	Vented
DA4627	LR016176	Range Rover L405	Front	Vented
DA4685 NEW	LR038934	Range Rover L405	Front	Vented
DA4686 NEW	LR033303	Range Rover L405	Rear	Vented
DA4687 NEW	LR033302	Range Rover L405	Rear	Vented
DA4618 NEW	LR007055	Range Rover Evoque	Front	Vented
DA4689 NEW	LR059122	Range Rover Evoque - 17"	Front	Vented
DA4683 NEW	LR027123	Range Rover Evoque	Rear	Solid

Anti-squeal Shims



DA1141

Universal self adhesive noise dampening shims. The shims are manufactured from wolverine and cut to shape and applied to the backing plate of the brake pads prior to fitting to help eliminate any noise issues (should the pad be unshimmed). When used in conjunction with Mintex CeraTec silicon based lubricant, most brake noise related issues will be eradicated. Pack quantity 4.

Brake Lubrication

DA2389

75ml Cera-Tec Advanced Lubricant Mintex Cera-Tec is an advanced non-metallic universal lubricant that provides many benefits over traditional copper-based grease.

- > Non-metallic content
- ABS and ESP friendly.
- > Operates to a high temperature (1,000°C).
- > Non-conductive.
- > Free of copper and acid.
- > More effective at reducing any brake squeal.
- > Protects against corrosion and dirt.
- > Neutral colour prevents any visible residue or staining.



EBC Brake Discs

Defender	Corresponds to			
DA4165	LR017951/FRC7329	Defender - 1987 - 2006 & 2007 onwards	Front	Solid
DA4151	LR017952/FTC902	Defender - 1987 - 2006 & 2007 onwards	Front	Vented
DA4152	LR017953/FTC1381	Defender - 1987 - 2006 & 2007 onwards	Rear	Solid
DA4855 NEW	SDB000330	Defender - 1987 - 2006 & 2007 onwards	Rear	Solid

Discovery				
DA4165	LR017951/FRC7329	Discovery 1	Front	Solid
DA4151	LR017952/FTC902	Discovery 1	Front	Vented
DA4152	LR017953/FTC1381	Discovery 1	Rear	Solid
DA4158	SDB000380	Discovery 2	Front	Vented
DA4148	SDB000470	Discovery 2	Rear	Solid
DA4187	SDB000614	Discovery 3	Front	Vented
DA4475	SDB000604	Discovery 3	Front	Vented
DA4188	SDB000646	Discovery 3	Rear	Vented
DA4473	SDB000636	Discovery 3	Rear	Vented
DA4496	SDB000624	Discovery 4	Front	Vented
DA4475	SDB000604	Discovery 4	Front	Vented
DA4188	SDB000646	Discovery 4	Front	Vented
DA4473	SDB000636	Discovery 4	Rear	Vented

Freelander				
DA4477	SDB101070	Freelander 1 - 1996 from 1A000001	Front	Vented
DA4551	LR000470/LR027107	Freelander 2 - petrol	Front	Vented
DA4549	LR001019	Freelander 2 - petrol	Rear	Vented
DA4552	LR007055	Freelander 2 - diesel	Front	Vented
DA4550	LR001018	Freelander 2 - diesel	Rear	Solid

Range Rover				
DA4165	LR017951/FRC7329	Range Rover Classic - 1986 - 1991	Front	Solid
DA4151	LR017952/FTC902	Range Rover Classic - 1986 - 1994	Front	Vented
DA4152	LR017953/FTC1381	Range Rover Classic - 1986 - 1994	Rear	Solid
DA4147	NTC8780	Range Rover P38 - 1995 - 2002	Front	Vented
DA4148	SDB000470	Range Rover P38 - 1995 - 2002	Rear	Solid
DA4187	SDB000614	Range Rover Sport - 2005 - 2009	Front	Vented
DA4475	SDB000604	Range Rover Sport - 2005 - 2009	Front	Vented
DA4496	SDB000624	Range Rover Sport - 2005 - 2009 & 2010 - 2013	Front	Vented
DA4188	SDB000646	Range Rover Sport - 2005 - 2013	Rear	Vented
DA4473	SDB000636	Range Rover Sport - 2005 - 2009	Rear	Vented
DA4474	SDB000201	Range Rover L322	Front	Vented
DA4476	SDB500193	Range Rover L322	Front	Vented
DA4472	SDB000211	Range Rover L322	Rear	Solid
DA4856 NEW	SDB500182	Range Rover L322	Rear	Vented
DA4488	LR017804/LR031844	Range Rover L322	Rear	Vented
	SDB500202/SDB500201	Note - not dimpled or slotted		
DA4552 NEW	LR007055	Range Rover Evoque	Front	Vented
DA4554 NEW	LR027123	Range Rover Evoque	Rear	Solid

EBC Ultimax Heavy-duty Brake Pads

- > New AF42/66 friction material which completely eliminates brake judder and produces a high friction long lasting brake pad.
- > Unique powder coat finish to both pad and back plate gives lifetime resistance to corrosion and prevents moisture ingress.
- > Unique Brake-In surface coating provides instant brake efficiency on installation and conditions the brake rotor removing glaze, black spotting etc from disc surface.
- > All pads feature centre line slot which prevents heat expansion cracks and reduces brake noise.
- > All pads feature edge chamfers which have major technical benefits;
 - Significant reduction in brake noise
 - Prevents 'edge lifting' under left and right extremities of pad which can cause corrosion ingress and eventual pad de-bond
 - Can extend pad life by virtue of improved pad efficiency
- > Most pads in the Ultimax range features factory fitted noise reduction shims.

EBC Green Stuff High Performance Brake Pads

- > 100% British design and manufacture.
- > Superb gloss powder coat paint finish to reduce corrosion.
- > Unique engineering finish with noise reduction slots and edge chamfers.
- > Extra high friction compounds for better stops, these pads will improve your stopping power by up to three vehicle lengths.
- > Special compound ingredients that prevent "Outline Etching" eliminating brake stiction onto the rotor in damp conditions.
- > Unique "Brake-In" surface coating to accelerate pad bed in after installing new pads which also guarantees brake efficiency from installation.
- > Super quiet braking with rubber-steel-rubber noise reduction shims on the reverse, this dampens all possible noise.
- > Extra heavy duty compound lasts longer than low cost standard pads.
- > Fully ECE R 90 approved and legal for road and off road use.

For full range of EBC brake pads - see overleaf

EBC Yellow Stuff Performance Race Brake Pads

- > High friction compound which is effective from cold up to high heat.
- > Effective brake upgrade for heavy-duty braking.
- > Long lasting powerful brakes.
- > Shims, edge chamfers and slots for silent braking.

EBC Yellowstuff brake pads are British made and contain Aramid fibres. These are man-made high performance fibres, used widely for their light-weight, high strength, abrasion resistance and thermal stability. These properties provide advantages over cheaper steel fibre based products. Not only high in friction from first application when brakes are cold but extremely effective at higher brake temperatures as encountered in faster driving and towing/trailing. These pads are a favourite with the military and are used on armoured vehicles in several countries to handle the higher loads and heat and offer a good brake upgrade. Fitted with shims chamfers, centre slots and the unique EBC Brake in coating for fast bedding in of new brakes these pads are also long lasting and silent in operation.

EBC Brake Discs

- > Sold in pairs.
- > 100% British cast and machined high quality product.
- > Wide aperture slots that draw cool air under the pad surface.
- > Slots that expel all dirt dust and debris from the braking area.
- > Blind drilled dimples that eliminate cracking common with through drilled sport rotors whilst helping maintain perfect pad contact.

IMPORTANT BRAKE INFORMATION

For exact change over points with vehicle applications please contact your local Britpart distributor with the full chassis number for the correct application. These references are intended as a guide only.



EBC BRAKES



Handbrake Conversion Kits

Driving off-road you'll know how easy it is for the standard Land Rover hand brake to get bunged up with dirt and once the mechanism gets clogged up it doesn't work as efficiently as it should. Britpart now offer a solution to that problem - a drum to disc conversion kit. These kits use powerful callipers whose mechanism is sealed to prevent the access of mud. Parts are supplied coated with a tough corrosion resistant coating of gold zinc passivate to ensure a long life. Fitting is easy requiring only simple tools. Full fitting instructions are included as well as advice on adjustment and use.

Defender/Discovery/Range Rover Classic

The disc transmission brake uses a state of the art monster sized mechanical calliper designed for agricultural vehicles and earth moving equipment - so using it on a Land Rover is easy work for it. The mechanism is sealed so it will not seize up due to ingress of mud or water and it uses special 'sintered' pads which are resistant to abrasion from mud as well as providing greater friction against the disc than a standard pad. The disc has been specially designed for Land Rovers and manufactured from tough 10mm thick steel. It has a smaller diameter than a standard drum and so does not dangle below the transfer box which helps it to protect it from whatever you are driving over. The calliper mechanism sits in a well protected area at the top, away from most of the mud and water.

DA5513
Defender 90 &110
For anything post 1993 (300Tdi, Td5 & Puma) you need to change the cable - NRC5088.

DA5526
Discovery 1/Discovery 2/Range Rover Classic
Will not fit a Borg Warner or LT95 transfer box.

XDISC
Replacement disc for DA5513 & DA5526

XPAD
Replacement pads for DA5513 & DA5526



Series DA5537 Series 1, 2 & 3
This will fit any Land Rover fitted with a standard Series transfer box, including those fitted with PTO's, under or overdrive units. The new brake replaces the original transmission brake drum. It is supplied with a new adjustable actuator rod which connects from your original handbrake lever, direct to the calliper, reducing the amount of slack in the linkages. The disc transmission brake uses an industrial open-frame calliper with simple adjustment and easy cleaning. The new calliper is mounted on a laser cut steel backplate with a folded gusset for added strength and incorporating a built in skid plate to protect the disc which is manufactured from robust 10mm thick mild steel plate and which bolts directly to your original gearbox output flange with six new bolts (supplied). The system is very light weight, offering a saving of almost 10kg compared to an original drum brake.



Beef Up Your Land Rover's Handbrake!



Photo courtesy of Louise Thompson

Engine



EGR Blanking Kits & Tubes

A Britpart EGR (exhaust gas recirculation) blanking kit enables you to remove the original mechanical EGR from the vehicle resulting in better fuel economy and improved performance.

DA1108 Defender - 300Tdi engine
Discovery 1 - 300Tdi engine
Range Rover Classic - 300Tdi engine

DA1109 Defender - Td5 engine
Discovery 2 - Td5 engine
Discovery 3 - TdV6 up to 7A (not EU4) engine

DA1112 Range Rover Sport - TdV6 up to 7A (not EU4) engine

DA1087 Freelander 1 - Td4 engine - tube only

DA1272 Range Rover P38 **NEW**

DA1088 Range Rover L322 - Td6 engine - tube only

EGR Blanking & Silicone Hose Kits



DA1108TDI
Defender - 300Tdi engine
Discovery 1 - 300Tdi engine
Range Rover Classic - 300Tdi engine



DA1109DEF
Defender - Td5 engine



DA1109DIS
Discovery 2 - Td5 engine



DA1087FL
Freelander 1 - Td4 engine



Filter Guards

- > Extends engine life
- > No vehicle modification needed
- > Added protection for stop & go driving and towing
- > Improves fuel economy
- > Cleans engine oil for 50,000 miles
- > Does not effect your Land Rover's warranty



Added protection for your engine!

Britpart Filter Guard removes potential engine damaging metal particles from your oil. Clean oil works better than dirty oil with reduced friction and less wear. Britpart's Filter Guard is an inexpensive way of removing the harmful contaminants that conventional oil filters can miss. The contaminants are fine metal particles which act like an abrasive on the fast moving parts in your vehicle's engine - dramatically shortening engine life. Filter Guard works by magnetic filtration technology resulting in cleaner oil which your engine will thank you for by running better now and in years to come. The Filter Guard will never clog or restrict the all important oil flow. **Note** - Filter not included with Filter Guard. Please check that there is sufficient room for the addition of the filter guard.



Part Number	Filter Guard (diameter x height)	Thread/Insert
DA6080	95mm x 30mm	3/4" x 16
Fits filters - AEU2218L & ERR3340		
Defender/Discovery 1/Discovery 2/Range Rover Classic/Range Rover P38		
DA6081	95mm x 30mm	3/8" x 16
Fits filter - RTC3186		
Range Rover Classic		
DA6082	77mm x 30mm	3/8" x 16
Fits filters - LPW100180L, LPW100230, STC974 & CDU1268		
Discovery 1/Freelander 1		
DA6084	77mm x 30mm	1" x 12
Fits filter - LR007160		
Discovery 3/Range Rover Sport - 2005 - 2009/Range Rover L322		

Britpart Performance Air Filters

A breath of fresh air for your Land Rover

- > A range of performance filters tailored to fit your Land Rover.
- > Maximum breathing efficiency for your engine means more power or better fuel mileage.
- > No compromise on quality - the engine gets more air but the dirt particles are trapped by the quality filters.
- > No need to replace as easy cleaning means maximum performance guaranteed.



- > Easy fit, directly replaces standard air filter.
- > Ideal for use in hot dusty conditions to reduce engine wear.
- > Compatible with snorkels, ideal for use in conjunction with other performance modifications.
- > Filters don't need pre-oiling and if the filter gets dirty there is no need to use a cleaner to clear the dirt on the filter - just use air, water or detergent.

"Breathing efficiency for your engine means more power or better fuel mileage"



To see an image of each filter go to www.britpart.com/filters

	Corresponds To		
Series 3			
DA3138	4-cylinder - fits Zenith and Weber carbs		
DA4274	605191 LWB - 3.5 V8 - 2 filters required	1979 - 1982	
Defender			
DA4269	NRC9238 2.5 petrol	1983 - 1990	
DA4269	NRC9238 2.5 D & Td	1983 - 1990	
DA4270	NTC6660 2.5 200Tdi	1990 - 1993	
DA4262	NTC1435 2.5 300Tdi	1994 - 1997	
DA4262	ESR2623 2.5 300Tdi	1994 - 1997	
DA4260	ESR4238 Td5	1999 - 2007	
DA4379	PHE500060 Puma	2007 -	
Discovery 1			
DA4274	605191 3.5 V8 carb - 2 filters required	1989 - 1990	
DA4262	NTC1435 2.5 200Tdi	1989 - 1992	
DA4262	ESR2623 2.5 200Tdi	1989 - 1992	
DA4268	RTC4683 3.5i V8 Efi	1990 - 1993	
DA4264	ESR1049 2.5 200Tdi	1992 - 1994	
DA4261	ESR1445 2.0i Mpi petrol	1994 - 1997	
DA4261	ESR1445 2.5 300Tdi	1994 - 1997	
DA4261	ESR1445 3.9i V8	1994 - 1997	
Discovery 2			
DA4260	ESR4238 Td5	1999 - 2004	
DA4260	ESR4238 4.0i	1999 - 2004	
Discovery 3			
DA3139	PHE000112 2.7 V6 diesel, 4.0 V6 petrol & 4.4 V8 petrol		
Discovery 4			
DA3139	PHE000112 2.7 V6 diesel, 3.0 V6 diesel & 4.0 V6 petrol		
DA4376	LR011593 5.0 V8 - nat. asp.		
Discovery Sport			
DA4637	LR029078 2.0 petrol & 2.2 diesel		
Freelander 1			
DA4267	ESR4103 1.8 16v	1997 - 2000	
DA4267	ESR4103 2.0i Tcie diesel (Rover engine)	1997 - 2000	
DA4263	PHE100500L 2.0 Td4 (BMW engine)	2001 - 2006	
DA4260	ESR4238 V6 petrol		
Freelander 2			
DA4375	LR005816 Petrol & diesel		
DA4637	LR029078 from CH000001 - 2.0 petrol		

	Corresponds To		
Range Rover Classic			
DA4274	605191 3.5 V8 carb - 2 filters required	1972 - 1986	
DA4272	3.5 carb V8 - cone type off-road extreme power filter		
		2 filters required	
		3.5 carb V8 - cone type - replaces 605191	
		2 filters required	
DA4266			
DA4268	RTC4683 3.5i V8 Efi	1985 - 1989	
DA4262	NTC1435 2.4D VM Turbo	1986 - 1992	
DA4262	ESR2623 2.4D VM Turbo	1986 - 1992	
DA4262	NTC1435 2.5D VM Turbo	1986 - 1992	
DA4262	ESR2623 2.5D VM Turbo	1986 - 1992	
DA4268	RTC4683 3.9i	1989 - 1994	
DA4265	ESR341 4.0i V8	1990 - 1995	
DA4265	ESR341 4.2i V8	1990 - 1995	
DA4265	ESR341 4.6i V8	1990 - 1995	
DA4264	ESR1049 2.5 200Tdi	1991 - 1993	
DA4261	ESR1445 2.5 300Tdi	1993 - 1995	
DA4261	ESR1445 3.9i V8 Efi	1992 - 1994	
Range Rover P38			
DA4265	ESR341 Diesel up to TA346793		
DA4265	ESR341 Petrol up to TA346793		
DA4260	ESR4238 Diesel from TA346794 up to VA376579		
DA4260	ESR4238 Petrol from VA346794 up to VA376579		
DA4260	ESR4238 Diesel from WA376580		
DA4260	ESR4238 Petrol from WA385949 up to WA410481		
DA4265	ESR341 Petrol from WA376580 up to WA385948		
DA4260	ESR4238 Petrol from XA410482		
Range Rover Sport			
DA3139	PHE000112 2.7 V6 diesel, 4.0 V6 petrol & 4.4 V8 petrol	2005 - 2013	
DA4376	LR011593 5.0 V8 nat. asp. & supercharged	2010 - 2013	
		2014 -	
Range Rover L322			
DA4378	PHE000050 4.4 V8 (BMW engine)	2002 - 2005	
DA4377	PHE500021 4.4 V8 nat. asp.	2006 - 2009	
DA4377	PHE500021 4.2 V8 supercharged	2006 - 2009	
DA4377	PHE500021 3.6 Td8	2007 - 2009	
DA4259	PHE000040 Td6	2002 - 2009	
DA4376	LR011593 4.4 Td8	2010 - 2012	
DA4376	LR011593 5.0 V8 nat. asp. & supercharged	2010 - 2012	
Range Rover Evoque			
DA4637	LR029078 2.0 petrol & 2.2 diesel		

K&N Air Filters

DA3137			
DA3136			
DA4275			
DA4273	Range Rover Classic - 3.9i Efi 1989 - 1992	Cone type, includes hose & fixing kit	
DA4375KN	Freelander 2 LR005816	Petrol & diesel	
	Discovery 4	5.0 V8 - nat. asp.	
DA4376KN	Range Rover Sport LR011593	5.0 V8 nat. asp. & supercharged - 2010 - 2013 & 2014 - 4.4 Td8 - 2010 - 2012 / 5.0 V8 nat. asp. & supercharged	
	Range Rover L322	4.4 V8 nat. asp. - 2006 - 2009	
DA4377KN	Range Rover L322 PHE500021	4.2 V8 supercharged - 2006 - 2009	
		3.6 Td8 - 2007 - 2009	
DA4378KN	Range Rover L322 PHE000050	4.4 V8 (BMW engine) - 2002 - 2005	
DA4275	K&N Dirt retention lubricating oil	200ml aerosol	
DA3136	K&N Cleaning solution	1ltr bottle	
DA3137	K&N Cleaning kit	200ml cleaning fluid & 200ml lubricating oil	



- > Designed to increase horsepower and acceleration.
- > Washable and reusable.
- > Easy high performance add-on.



Intercoolers - Performance



DA4635
Discovery 3 - 2.7 TdV6
Range Rover Sport - 2.7 TdV6
The original Land Rover intercooler design can have problems due to the blocking up of the core with mud when the vehicles are used off road, as the intercooler is mounted at the lowest point in the front of the vehicle. This intercooler is designed to be easier to clean and less prone to blockage due to the courser, less dense fin design whilst dramatically improving flow, performance and economy, even without any further tuning. Tests have shown a minimum improvement in fuel economy of 12-15%. Power and throttle response in the lower and mid-range engine revs particularly are noticeably improved. The intercooler is designed to be simple to install without major modifications to the vehicle. The performance intercooler makes full use of the space available behind the bumper. It is designed with an integral fan cowl extension to ensure no loss of cooling efficiency and is supplied with mounting brackets and fitting guide.

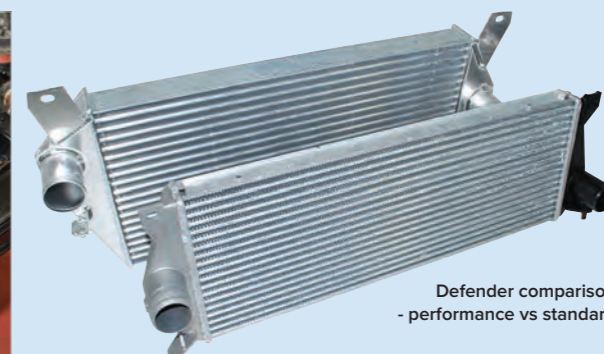

Defender comparison - performance vs standard

Increase Engine Power & Reduce Fuel Consumption

DA4630	Defender 90/110 - Td5 - 1998 - 2006 inc. air-con vehicles	60mm deep x 300mm high
DA4634	Defender 90/110 - 2007 onwards inc. air-con vehicles	60mm deep x 300mm high
DA4631	Discovery 2 - Td5 Automatic/manual with transmission oil cooler - 1999 - 2004	60mm deep x 235mm high
DA4632	Discovery 2 - Td5 Manual without transmission oil cooler - 1999 - 2004	60mm deep x 300mm high
DA4633	Range Rover P38 - DSE	60mm deep x 280mm high

Note - Dimensions for main intercooler body only. If you have a winch fitted please check clearance before fitting.

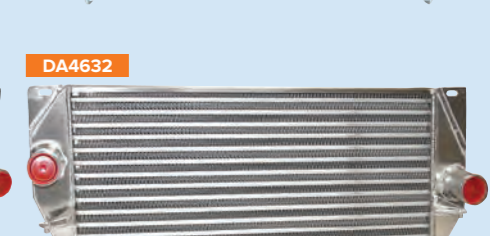
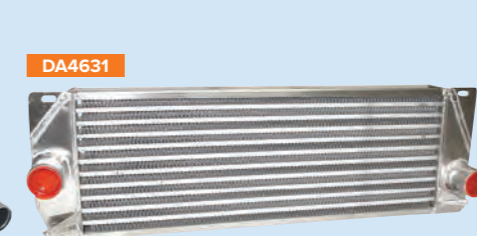
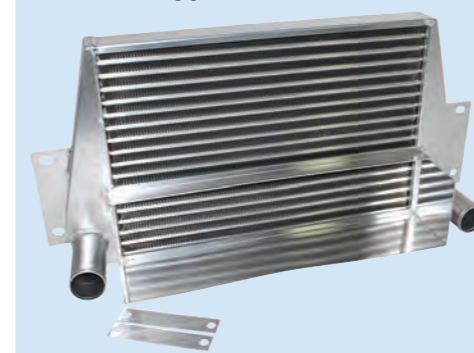

This intercooler is designed to be easier to clean and less prone to blockage.



Silicone Hose Kits

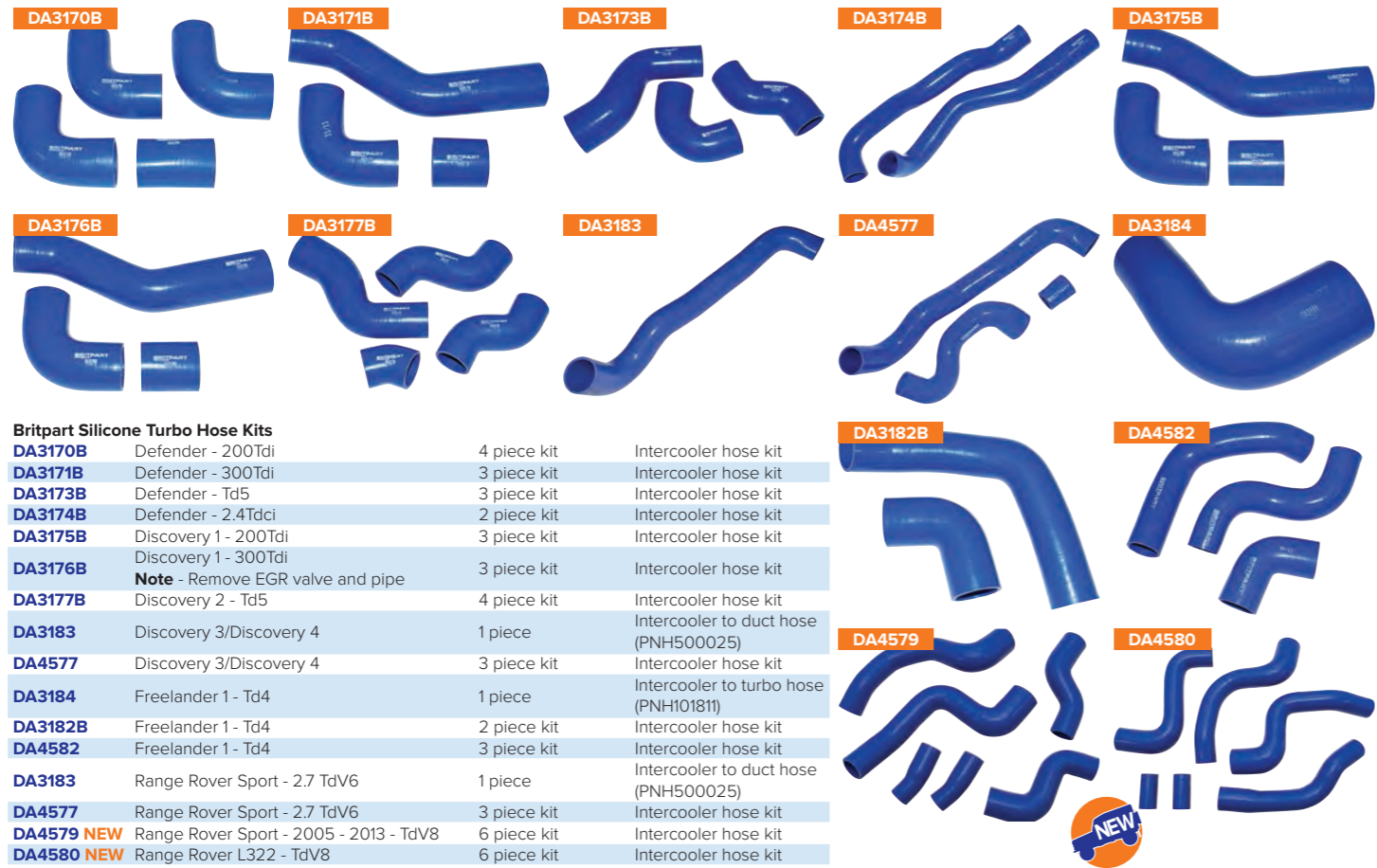

Britpart Silicone Turbo Hose Kits			
DA3170B	Defender - 200Tdi	4 piece kit	Intercooler hose kit
DA3171B	Defender - 300Tdi	3 piece kit	Intercooler hose kit
DA3173B	Defender - Td5	3 piece kit	Intercooler hose kit
DA3174B	Defender - 2.4Tdc	2 piece kit	Intercooler hose kit
DA3175B	Discovery 1 - 200Tdi	3 piece kit	Intercooler hose kit
DA3176B	Discovery 1 - 300Tdi	3 piece kit	Intercooler hose kit
DA3177B	Discovery 2 - Td5	4 piece kit	Intercooler hose kit
DA3183	Discovery 3/Discovery 4	1 piece	Intercooler to duct hose (PNH500025)
DA4577	Discovery 3/Discovery 4	3 piece kit	Intercooler hose kit
DA3184	Freelander 1 - Td4	1 piece	Intercooler to turbo hose (PNH101811)
DA3182B	Freelander 1 - Td4	2 piece kit	Intercooler hose kit
DA4582	Freelander 1 - Td4	3 piece kit	Intercooler hose kit
DA3183	Range Rover Sport - 2.7 TdV6	1 piece	Intercooler to duct hose (PNH500025)
DA4577	Range Rover Sport - 2.7 TdV6	3 piece kit	Intercooler hose kit
DA4579 NEW	Range Rover Sport - 2005 - 2013 - TdV8	6 piece kit	Intercooler hose kit
DA4580 NEW	Range Rover L322 - TdV8	6 piece kit	Intercooler hose kit

Britpart Silicone Coolant Hose Kits			
DA4571 NEW	Defender - 200Tdi	6 piece kit	Coolant hose kit
DA4570 NEW	Defender - 300Tdi	3 piece kit	Coolant hose kit
DA4572 NEW	Defender - Td5	1 piece	Coolant top hose kit
DA4573 NEW	Defender - Td5	2 piece kit	Coolant hose kit
DA4575 NEW	Defender - 2.4Tdc - 2007 - 2012	2 piece kit	Coolant top hose kit
DA4568 NEW	Discovery 1 - 200Tdi	3 piece kit	Coolant hose kit
DA4567 NEW	Discovery 1 - 300Tdi	3 piece kit	Coolant hose kit
DA4569 NEW	Discovery 2 - Td5	1 piece kit	Coolant top hose kit
DA4574 NEW	200Tdi & 300Tdi engines	3 piece kit	Expansion tank bleed kit

> Quality silicone hoses are designed to operate at a higher temperature than the original hoses.
 > Will not rot or perish like rubber hoses.
 > Fit with both standard and performance intercoolers.

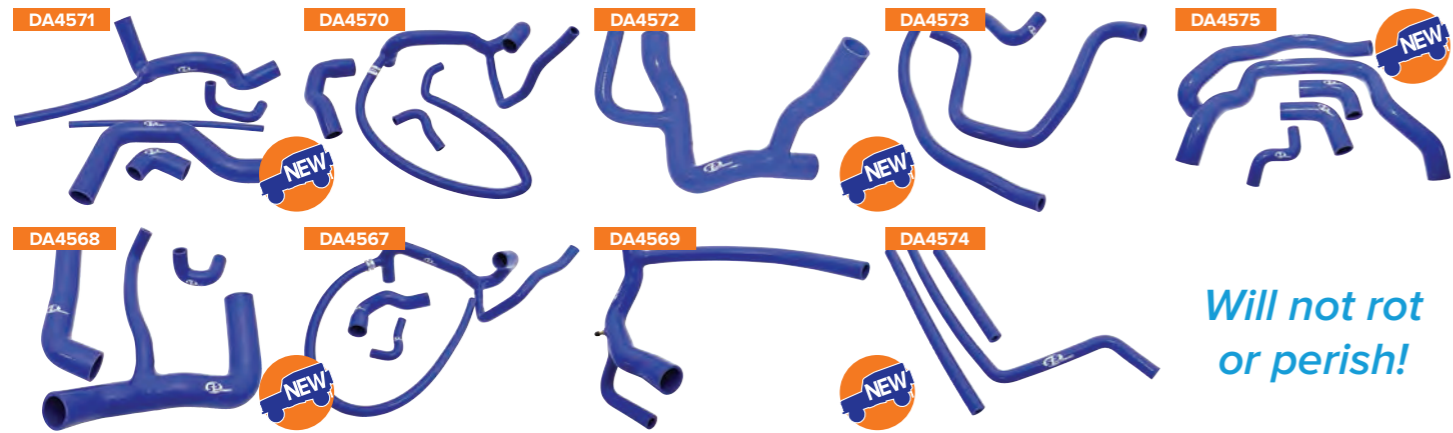

Will not rot or perish!

Aluminium Header Tanks NEW



This is a direct replacement for the original plastic tank which is prone to splitting. TIG welded by hand and manufactured from high specification lightweight non-corrosive alloy, this tank also aids cooling. Tank uses original pressure release screw cap and is a straight fit with no modifications required. Ideal for motorsport, overland or just to improve the look of your vehicle's engine bay.

DA4750 NEW	Defender - 200Tdi/300Tdi/V8
DA4751 NEW	Discovery 1 - 200Tdi/300Tdi/V8
DA4751 NEW	Range Rover Classic - petrol & diesel - 1990 onwards
DA4751 NEW	Defender - Td5 & Td4 Tdci

Electric Fan Kits NEW

Revotec Electronic Fan Conversion Kits
 > Custom engineered to fit and cool your Land Rover perfectly.
 > Supplied complete with all necessary fittings and fixings to complete an electronic fan conversion on your vehicle. Kits include mounting brackets or shroud, 35mm Revotec electronic fan controller designed for Land Rovers with an extended loom, earth wire kit and bolts & fixings.
 > Engineered to fit without any permanent modifications and utilising original radiator mountings.
 > Easy to install with basic hand tools.
 > Latest fan and controller technology used together for the ultimate cooling package.

DA8963 NEW	Series 3	14" High power sucking fan
DA8964 NEW	Series 3 V8	2 x 12" High power suction fans
DA8965 NEW	Ninety/One Ten - 2.5 petrol/2.5 diesel/2.5 TD	15.2" High power suction fan
DA8966 NEW	Ninety/One Ten - V8	2x 12" High power suction fans
DA8967 NEW	Defender & Discovery - 200Tdi/300Tdi	15.2" High power suction fan
DA8968 NEW	Defender & Discovery - Td5	15.2" High power suction fan
DA8969 NEW	Defender - Tdci	15.2" High Power Suction fan,
DA8970 NEW	Range Rover P38	15.2" High power suction fan



Custom engineered to fit and cool your Land Rover perfectly



Air Conditioning Fans
DA8971 NEW Defender
 This is a direct replacement to the vehicles original air conditioning fan. Kit contains - 1 x 10" blowing fan.
DA8972 NEW Discovery 2
 This is a direct replacement for OEM Part No. JRP100000. Kit contains - 1 x 12" high power blowing fan, 2 x anodised brackets & 1 x fixing kit.



Electronic Fan Controller
DA8973 NEW
 > 35mm
 > To fit extended loom
 > Negative earth housing. Fits directly in to a radiator top or bottom hose for direct water contact.
 > Supply Voltage: 12v
 > Space in hose approx: 35mm
 > Overall length approx: 65mm
 > Material: Aluminium
 > Relay Rating: 30 AMPS
 > Wire Length: 2500mm
 Kit contains - 2 x hose clamps, relay, cap, 3 x cable ties, fitting instructions.

Fan Override Switch
DA8974 NEW
 3-way rotary switch for use with a Revotec fan controller enabling the fan to be manually controlled either on, off or automatic. Perfect for 4x4 applications such as wading. This product must be used with a Revotec electronic fan controller. Kit contains - Black anodised mounting bracket kit. Position decal. Sealed 3m wiring loom and connection diagram.



PSI Power Tuning Products



Improves torque
Improves m.p.g

The Power Box houses a digital microprocessor which intercepts the fuelling signals being transmitted from the ECU to the fuel pump; it then modifies them to ensure the exact amount of diesel required for enhanced performance. Such efficient use of the fuel optimises consumption, reduces smoke emissions and there is less engine stress, enhancing engine life in many cases. The Power Box improves torque enabling the vehicle to change gears earlier and hold higher gears at lower speeds, making driving more pleasurable. The unit fits using the original manufacturers plugs; these existing plugs are opened and the Power Box is secured in between. Full fitting instructions are included with every unit.

Features

- > Plug-in unit
- > No intervention with the original ECU
- > TUV approval
- > Compact size
- > Shock resistant & waterproof
- > Competitively priced

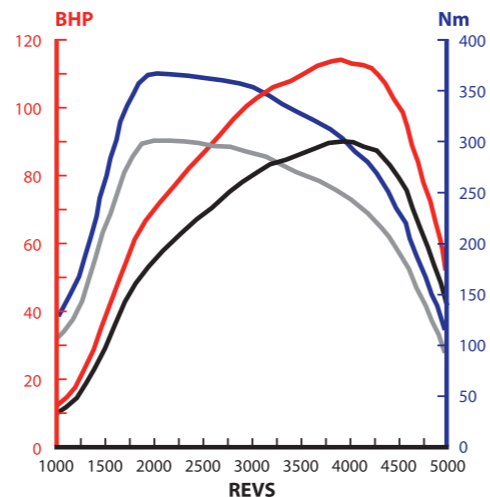

DA4418	Freelander 1 - Td4 - 2000 - 2006	Power - HP	Power - Kw	Torque - Nm
DA4419	Range Rover P38 - 2.5Td - 1995 - 1999	110 / 135	82 / 101	260 / 309
DA4420	Range Rover P38 - 2.5Td - 2000 - 2001	134 / 162	100 / 121	268 / 319
DA4421	Range Rover L322 - Td6 - 2002 onwards	175 / 204	130 / 152	390 / 449
DA4433	Defender/Discovery 2 - Td5 - 1999 - 2007	121 / 158	90 / 118	300 / 374
DA4436	Defender - 2.4TdcI - 2007-2011	121 / 153	90 / 114	360 / 424
DA4434	Discovery 3/Range Rover Sport - 2.7 TdV6 - EU3	188 / 220	140 / 164	440 / 519
DA4435	Discovery 4/Range Rover Sport - 3.0 TdV6	252 / 286	188 / 213	600 / 677

Power improvement - before / after	Power - HP	Power - Kw	Torque - Nm
Standard	121Hp	90Kw	300Nm
With PSI	158Hp	118Kw	374Nm

Performance for Defender - Td5
Standard 121Hp 90Kw 300Nm
With PSI 158Hp 118Kw 374Nm

Benefits

- > Can be removed prior to sale or used as a selling point
- > Traceless
- > Peace of mind
- > Quality product which is legal & safe
- > Unobtrusive in interior of vehicle
- > No worries off road
- > A good investment

Turbo Boost Box

DA4667

The Td5 engine fitted in Defenders and Discovery's is one of the most 'tunable' engines available and it responds well to modifications including a PSI power tune box, larger intercooler, EGR removal kit and decat pipes. However the turbo will only boost to 14.7psi in standard form and this will quickly limit the potential from the modifications you have made. The ECU will cut fuel to the engine if it detects an over boosting situation, but there is a solution.

Turbo Boost Box! This intelligent box allows the Td5 engine to run with a higher boost pressure after adjusting the waste gate in accordance with the instructions. This allows increased turbo boost pressure without the engine going into limp home mode. You will feel the benefits of fitting the Turbo Boost Box as soon as you drive. At the lower rpm's the vehicle will feel more responsive whilst at the same time giving you a much smoother spread of power through the rpm range. An added benefit is a reduction of exhaust smoke.

You will feel the benefits of fitting the Turbo Boost Box as soon as you drive!

Fitting the Turbo Boost Box is an easy 3 wire installation. The box is manufactured from extruded aluminium and easy to fit as it uses the original Land Rover connectors. The box is 99% water resistant - ideal for most off-road uses. This product must be fitted by a competent mechanic in accordance with the included instructions, incorrect waste gate adjustment can lead to engine damage.



Weber Carburettors

DA3049



Part of the conversion kit

DA3049

V8 4-Barrel conversion kit including manifold
The Webcon 4 barrel replacement carburettor kit is a direct replacement for the twin Stromberg or SU carbs fitted to the Rover V8. Calibrated to work perfectly on the 3.5 and 3.9 engines, the Webcon kit is the most complete on the market and features a Webcon modified Weber 4 barrel 500cfm carburettor, intake manifold, air filter and every single nut, bolt washer, gasket and hose that could possibly be needed. The kit adds up to 20bhp at the wheels and transforms the driveability and economy. Starting becomes instant either hot or cold and with no balance adjustment to worry about with twin carbs, the engine is simply superbly smooth as a V8 should be.

ERC2886W



ERC2886W

Series - replacements for the Zenith 36IV
Available for LHD, RHD, with or without fuel shut off solenoid, the Weber range of carburettor kits to replace the Zenith 36IV offer the optimum balance of power and economy together with the legendary quality and reliability of Weber. Shipped as complete turnkey solutions, all kits are supplied with every nut, bolt, washer and gasket required and comprehensive, easy to follow instructions ensure that installation can be carried out with no specialist carburettor knowledge.

- DA3049AF Replacement air filter for DA3049
- DA3049KD Weber kick down kit for use with DA3049 on automatic vehicles.

DA4538



DA4538

Twin choke performance carburettor kit for Land Rover 2.25ltr engines.
The kit is fitted with Webcon's new Sync Link kit allowing synchronous opening of the Weber 32/36 DGV throttle butterflies. This greatly enhances low speed driveability and torque, essential for off-road driving. This kit will fit all engines fitted with a tubular exhaust manifold. If the original exhaust manifold is still fitted, a simple 4-hole blanking plate will need to be fabricated to block the aperture left when the OE intake manifold is removed.

- DA2126 Series carburettor - to replace Solex use also STC541 adaptor
- DA2126A Choke cable for DA2126
- DA2206 Service kit for DA2126 & ERC2886W



NEW Sign up to the regular Britpart newsletter to find out about all the latest product releases.
www.britpart.com/newsletter

Tuning Box



DA4507
Tuning box for the Defender - Puma 2.2TdcI
Power increases by 27bhp (20kw)
Torque increases by 71Nm

The 2011 onwards 2.2 Tdci model Defender has new style piezo injectors and requires specialised tuning solutions. It is currently not possible to remap the ECU through the OBD port. This substantial new tuning unit is designed to plug directly into the wiring loom and requires no modification to the vehicle. Contained in waterproof housing so can be safely located in the engine bay.



Photo courtesy of Per Olav Stenberg

Tunit

DA4437
Freelander 2 - 2.2 Td4 - 2007 onwards
Power improvement - before / after
Power - HP 152 / 177
Power - Kw 112 / 130
Torque - Nm 295 / 325



Tunit Diesel Performance - The Diesel Tunit has been forged from many years of experience to bring a world class unbeatable range of diesel performance solutions.

Tunit Features - Tunit possesses many advantageous features not seen in other tuning solutions such as chips, eprom serial reprogramming (flashing) or other types of fixed map devices. It is interchangeable between vehicles and able to be upgraded. External to the ECU or 'Plug and play' as it is often called means no interference with the original manufacturers engine equipment. Its option to adjust power and performance provides easy manual adjustment for the novice or finer electronic alterations for the more dedicated tuner.

Fuel Savings - Tunit has become advantageous in reducing fuel costs for a variety of applications; not just improving performance but now helping with saving fuel costs.

Installation - The Tunit is normally connected to original plugs on the vehicle and can either be self-installed or by a professional mechanic.

Upgrade Chips

DA4497 Range Rover P38
Replacement ECU chip to improve power and economy on the GEMS engine 4.0 and 4.6 in the Range Rover P38. Fitting this chip will increase economy by approx 15% and power by 10%. Once fitted, it helps makes a big difference to the driveability of the vehicle by improving throttle response and mid-range pull.

No trade off between fuel economy and increased power!



Accelerate technology
Limitations and restrictions exist which prevent your vehicle from achieving optimal performance. The manufacturer's emissions test is extremely rigorous due to inclusion of all parts of the driving cycle, especially warm up and full load operation, which is where problem emissions are at a maximum. To meet these they compromise performance and efficiency of the engine - this chip helps redress that balance.

Off roaders in the driving seat
Your requirements are met through a stable and predictable idle quality, good engine braking and an engine which has plenty of midrange torque. Perfect idle control for hill descents and winching, with no possibility of stalling. Total reliability ensures you never lose control.

Greater expectations
By comparison we know climate conditions and fuel quality your vehicle experiences and can therefore improve efficiency by reducing fuel consumption and optimising the engine to get its best performance on full load, which is less than 10% of the time.

Exhaust Systems

Stainless Steel Exhaust



DA3340
Discovery 4
3 litre diesel with DPF

Front Downpipes

- DA3262 Defender 300Tdi - downpipe less cat Equivalent to ESR2297
- DA4348 Defender 90 - Equivalent to WCD000960 Discovery 2 - Equivalent to WCD000500 Td5 - downpipe less cat - mild steel
- DA4359 Defender 90 - 2.4 EU4 2007 onwards - downpipe less cat Equivalent to LRO20683
- ESR2740 Discovery 1 Range Rover Classic 300Tdi - downpipe less cat Equivalent to ESR2440
- DA4396 Discovery 3 TdV6 - downpipe less cat Equivalent to WCD500433
- Note - Fitting downpipe may then require vehicle needing an engine re-map by a specialist.

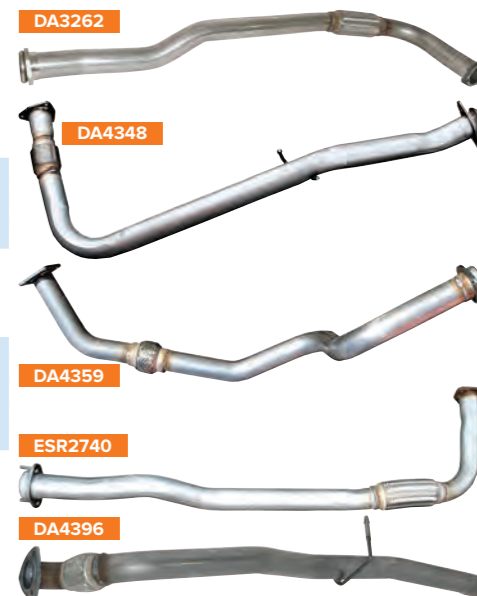

Double 'S' Stainless Steel Exhausts

Stainless Steel - Standard Exhaust Systems

Series	Model	Engine	Configuration
DA4540	Series 1 - 88"	2.25 diesel - 4 stud manifold exit	Front pipe / link pipe / rear silencer
DA4251	Series 3 - SWB	2.25 diesel - 3 stud manifold exit	Front pipe / link pipe / rear silencer
DA4528	Series 3 - SWB	2.25 petrol	Front pipe / link pipe / rear silencer
Defender			
DA4231	Defender 90	200Tdi	Front pipe / centre box / rear silencer
DA4232	Defender 90 - 1994 - 1995	300Tdi	Front pipe / centre box / rear silencer
DA4233	Defender 90 - 1995 - 1997	300Tdi	Front pipe / centre box / rear silencer
DA4234	Defender 90 - 1997 - onwards	300Tdi	Centre box / rear silencer
DA4235	Defender 90	Td5	Centre box / rear silencer
DA4244	Defender 110	Td5	Centre box / rear silencer
DA4228	Defender 110	200Tdi	Front pipe / centre box / rear silencer
DA4229	Defender 110	300Tdi	Front pipe / centre box / rear silencer
Discovery			
DA4221	Discovery 1	2.5Td & 200Tdi Manual	Front pipe / centre box / rear silencer
DA4222	Discovery 1	200Tdi Automatic	Centre box / rear silencer
DA4223	Discovery 1	300Tdi	Centre box / rear silencer
DA4224	Discovery 2	Td5	Centre box / rear silencer
DA4397	Discovery 3	TdV6	Twin tail exhaust
Freelander			
DA4226	Freelander 1	1.8 petrol - up to YA999999	Centre box / rear silencer
DA4246	Freelander 1	1.8 petrol - up to YA999999	Transplex rear silencer (2 x 3" roll tailpipe)
DA4227	Freelander 1	2.0 diesel - up to YA999999	Link pipe / rear silencer
Range Rover			
DA4237	Range Rover Classic - cat & non-cat	3.9 V8 from catalyst to back	Centre box / rear silencer
DA4238	Range Rover P38	2.5 BMW diesel single tailpipe	Centre box / rear silencer
DA4239	Range Rover P38	4.0/4.6 single tailpipe	Centre box / rear silencer
DA4240	Range Rover P38	4.0/4.6 twin tailpipe	Centre box / silencers - RHS & LHS
DA4241	Range Rover P38	2.5 BMW twin tailpipe	Centre box / silencers - RHS & LHS
DA4395	Range Rover Sport	4.2 V8 Supercharged	Centre box / link pipes - RHS & LHS / rear silencers - RHS & LHS
DA6815 NEW	Range Rover Sport	4.4 - 2005 - 2009	Front silencer / link pipes - RHS & LHS / rear - RHS & LHS
DA6816 NEW	Range Rover Sport	5.0 - 2009 - 2012	Front silencer / link pipes - RHS & LHS / rear - RHS & LHS
DA6810 NEW	Range Rover L322	4.2 - 2002 - 2005	Link pipes - RHS & LHS / silencer
DA6812 NEW	Range Rover L322	4.2 - 2005 - 2009	Link pipes - RHS & LHS / twin rear silencer
DA6811 NEW	Range Rover L322	4.4 - 2002 - 2005	Link pipes - RHS & LHS / silencer
DA6813 NEW	Range Rover L322	4.4 - 2005 - 2009	Link pipes - RHS & LHS / twin rear silencer
DA6814 NEW	Range Rover L405	5.0 Supercharged - 2012 onwards	Front silencer / link pipe RHS & LHS / rear silencer RHS & LHS
DA6817 NEW	Range Rover Evoque	2.2 - 2011 onwards	Link pipe / Y-section / tail pipe - RHS & LHS

Double 'S' is recognised as one of Europe's leading manufacturers of stainless steel automotive components with a wide selection of systems for off-road.

Using only the finest austenitic and ferritic stainless steels and employing the latest in CNC mandrel and empty tube bending, measuring and inspection equipment, means increasingly high levels of product quality.



All Double 'S' exhaust systems carry a lifetime guarantee. Double 'S' will replace or repair any part of their Stainless Steel Exhaust Systems found defective through corrosion during the period that the system remains the property of the original owner. Provided that the system is inspected by a garage or exhaust fitting centre annually to ensure that the rubber and other mountings are in good condition.



For more images - www.britpart.com/double-s

Exhaust Fitting Kit
 Series - SWB
DA1293 NEW
 RHD
DA1294 NEW
 LHD

Lifetime Guarantee

NEW

Double 'S' Stainless Steel Exhausts - continued

Stainless Steel - Sports Exhaust Systems

Model	Engine	Configuration
Defender		
DA4236	Defender 90	3.5 V8 sports system
DA4249	Defender 90	Td5 sports system
DA4230	Defender 110	3.5 V8 sports system
Discovery		
DA4225	Discovery 1	3.9 V8 Japanese spec sports system
Range Rover		
DA4242	Range Rover Classic	3.5 V8 Efi sports system with tubular manifold
DA4243	Range Rover Classic	3.9 V8 Efi sports system with tubular manifold
DA4243EXT	Range Rover Classic	Extension piece for DA4243 for use on long wheel base Range Rover Classic LSE models
DA4245	Range Rover P38	4.0/4.6 sports system with twin tailpipe
DA4247	Range Rover P38	2.5 diesel sports system with twin tailpipe



Utility Link Pipes & Rear Silencers

Britpart Link Pipe	Double 'S' Rear silencer	Model
DA4371	DA3250	Defender 90 - 2007 onwards
DA4292	DA3250	Defender 90 - Td5
DA4294	DA3251	Defender 90 - 300Tdi 1994 - 1995
DA4294	DA3252	Defender 90 - 300Tdi 1995 - 1997
DA4304	DA3253	Defender 90 - 300Tdi 1997 - 1999
DA4295	DA3254	Defender 90 - 200Tdi
DA4372	DA3255	Defender 110 - 2007 onwards
DA4293	DA3255	Defender 110 - Td5
DA4302	DA3256	Defender 110 - 300Tdi
DA4306	DA3257	Defender 110 - 200Tdi
Discovery		
DA4291	DA3258	Discovery 1 - 300Tdi
DA4303	DA3259	Discovery 1 - 200Tdi
DA4223S		Discovery 1 - 300Tdi Sport system kit
ESR2391S		Discovery 1 - 300Tdi Sport system kit
DA4290	DA3260	Discovery 1 - 300Tdi
DA4290		Discovery 2 - Td5
DA4537		Freelander 1 - Td4

These stainless steel exhaust silencer replacement pipes are designed to directly replace the front silencer in your exhaust system. Once replaced the pipe will give your vehicle more power or reduced fuel consumption with only a small increase in cabin noise. CNC mandrel formed for a perfect fit with laser cut flanges, the pipes have a sateen finish, deep lustre appearance. Quick and easy to install.



Reduced fuel consumption

Quick and easy to install with more power

Suspension & Axle Equipment

Upgrade your shock absorbers or springs for improved ride quality and reliability. Britpart have plenty of suspension and axle equipment to meet your specific requirements to ensure a smoother ride!

Air Suspension Compressors	126	Propshafts	
Axle		Propshaft kit.....	135
Anti-roll bar kits.....	120	Propshaft spacer kit.....	135
Bush kits.....	120	Wide angle propshafts.....	135
Castor corrected swivel housings.....	120	Shock Absorbers	
Fulcrum brackets.....	120	Bilstein.....	129
Heavy-duty drive flanges.....	120	Britpart Cellular Dynamic.....	128
Panhard rods.....	120	Britpart Super Gaz.....	128
Radius arms.....	121	Britpart XD remote reservoir.....	127
Suspension arm & bolt kits.....	121	Delphi De Carbon.....	129
Suspension bolt kits.....	121	Heavy-duty.....	127
		Old Man Emu.....	129
Brackets, Mounts & Ancillary Products		Springs	
Adjustable ball joint.....	122	Air lift kits.....	130
Dislocation cones.....	122	Air spring conversion kits.....	133
Lift rod kit.....	123	Leaf spring castor correction wedges.....	131
Rear spring sets.....	122	Springs - air.....	130
Shock absorber brackets & turrets.....	122	Springs - coil - lifted.....	132
Spring retainers.....	122	Springs - coil - lowered.....	131
Spring spacer blocks.....	123	Springs - coil - standard.....	132
Turret rings.....	122	Springs - leaf.....	130
Bushes		Springs - Old Man Emu.....	131
Bump stops.....	124	Springs - parabolic.....	130
Bush fitting tool.....	124	Steering	
Bush set - Watts linkage.....	124	Steering arms - heavy-duty.....	135
Bush sets - castor corrected.....	124	Steering dampers.....	135
Bush sets - Polybush.....	124	Suspension Kits	134
Bush sets - Britpart.....	126		
Bush sets - Britpart polyurethane.....	125		
Bush sets - Powerflex.....	126		

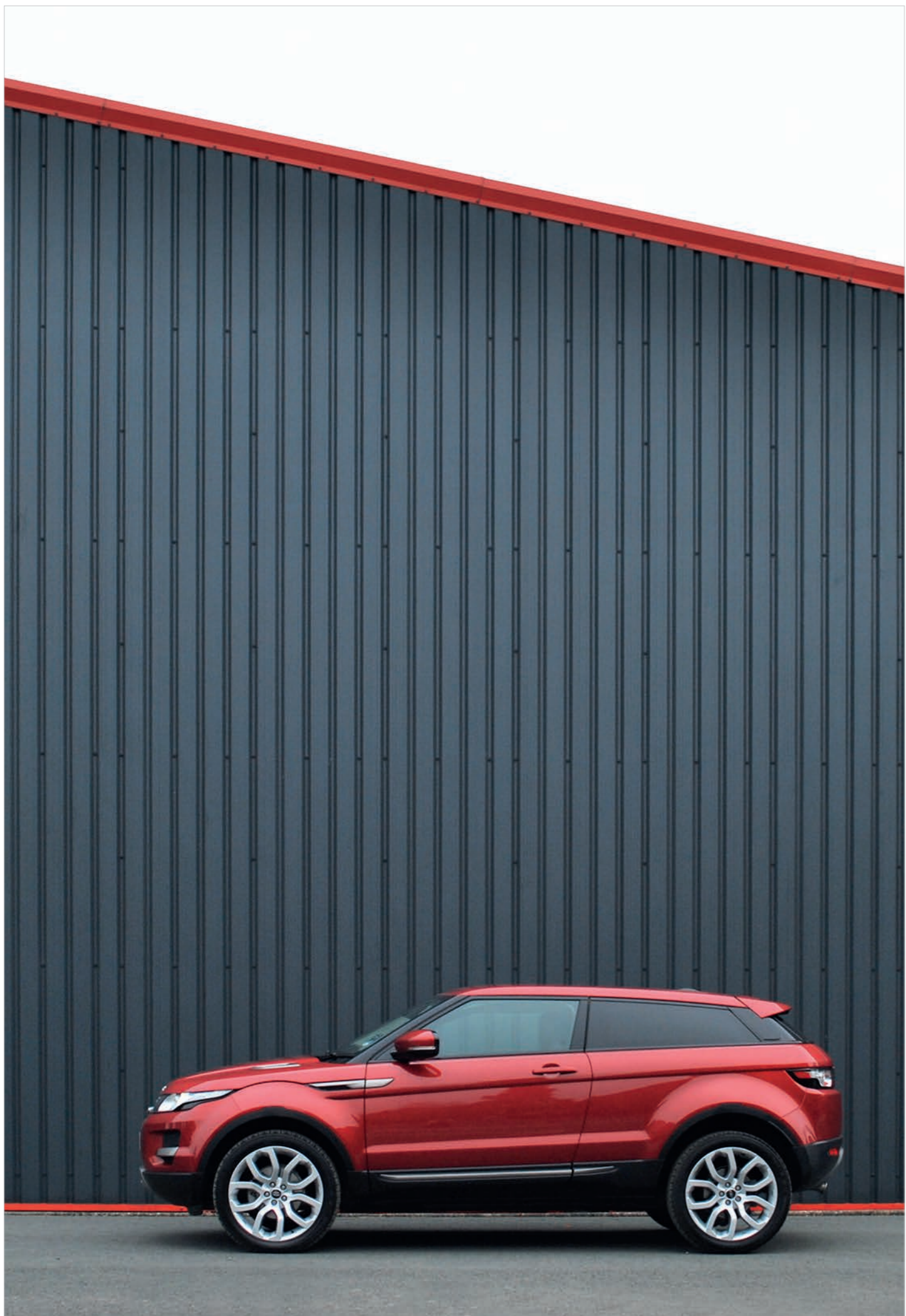

Axle

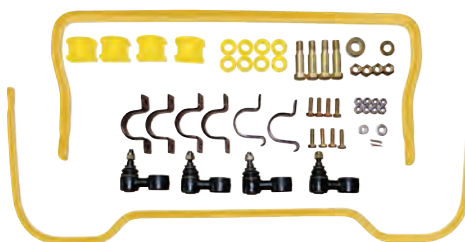

STC8156AAPY
Defender 90, 110 & 130/Discovery 1/Range Rover Classic
Yellow anti-roll bar kit with Britpart yellow polyurethane bushes.

Stiffen up your Land Rover! Front and rear kits complete with fitting instructions. Only suitable for vehicles with the chassis and axle brackets fitted.

Note - To fit these anti-roll bars to the rear of a Defender 90 Td5 - onwards 2 x EGP1661L & 2 x EGP1889 are required. To fit to a Defender 110/130 Td5 - onwards 2 x NRC5674 & 2 x 592773 are required.

Anti-Roll Bar Kits



STC8156AA
Defender 90, 110 & 130/Discovery 1/Range Rover Classic
Black anti-roll bar kit with rubber bushes.

Fulcrum Brackets



Fulcrum brackets
Defender/Discovery 1/Range Rover Classic

DA1129
With ball joint assembly (ANR1799)

DA1129G
With OEM ball joint assembly (ANR1799G)

DA1129ADJ
With adjustable ball joint assembly (ANR1799A)

DA1129KIT
Fitting kit for all fulcrum brackets

DA1129ULTRA
Fulcrum bracket with high articulation for Defender
Discovery 1
Range Rover Classic

DA1129ULTRA

One of the major factors limiting the rear suspension movement on vehicles fitted with an A-frame is the standard ball joint. We have developed this part to provide significantly more articulation than the standard and most aftermarket joints. Others claim more articulation yet in reality they offer very little over the standard 30°. This exclusive ball joint offers 45° movement in all directions. It is easily adjustable with a regular hex spanner and has a grease nipple for convenient regular maintenance. It is supplied fitted ready to bolt to your Land Rover.

Castor Corrected Swivel Housings



'3 degrees of additional castor'

DA3203
Defender - from LA up to WA
Normally the only way to correct the castor angle on a beam axle vehicle is to fit castor corrected radius arms or go through the lengthy process of repositioning the brackets on the axle. Something which takes considerable time and skill. Britpart offer you an alternative. These castor corrected swivel housings come as a handed pair. They are a direct replacement for vehicles normally using the FRC7065 swivel housing but they have the mounting holes positioned to give 3 degrees of additional castor. The swivel housings are from the OEM supplier and then machined to our specification.

Kit contents - Swivel housings; swivel pin bearings; gaskets; seals; plates; shims; joint washers; swivel pin uppers - non-ABS & swivel housing grease sachets.

Bush Kits



Front bush kits include bushes for radius arms and panhard rods.
Rear bush kits include bushes for top & bottom links.

DA1242	Range Rover Classic - up to 1985	Front bush kit
DA1243	Range Rover Classic - up to 1985	Rear bush kit
DA1244	Defender - up to KA	Front bush kit
DA1245	Defender - from LA up to VA130784	Front bush kit
DA1246	Range Rover Classic - from 1986 onwards	Front bush kit
DA1247	Defender - from VA130785 up to 2A626645	Front bush kit
DA1247	Defender - from 2A626646 onwards	Front bush kit
DA1248	Defender to 9A768936/Discovery 1	Rear bush kit
DA1248	Range Rover Classic from 1986 on	Rear bush kit
DA1249	Defender from 9A768937	Rear bush kit

Heavy-Duty Drive Flanges



These heavy-duty drive flange kits have been engineered to outperform many of the inferior products available on the market. Manufactured from 5140 steel, they are much stronger than an OE drive flange. Complete with hex head bolts and screw on caps with integral seal.

DA1148	Defender - from LA/Discovery 1 - from JA Range Rover Classic - ABS and front from JA	Pair
DA1149	Defender - up to KA	Pair
DA1148CAP	Replacement drive flange cap with rubber seal for DA1148 & DA1149	Single
DA1128	Replacement drive flange bolt set for DA1148 & DA1149	Qty 10

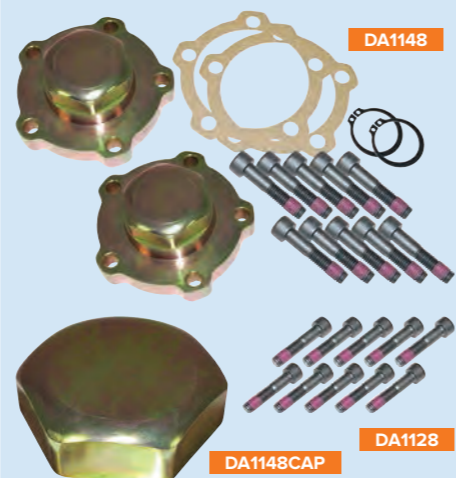

Panhard Rods

If your Land Rover has raised suspension it is wise to use an adjustable panhard rod to correct the axle position which will in turn maintain and restore the steering geometry.

DA1130
Defender Td5 & 2007 onwards
Complete with yellow polyurethane bush set



DA1110
Defender - up to 2002
Discovery 1
Range Rover Classic
Complete with yellow polyurethane bush set

Radius Arms

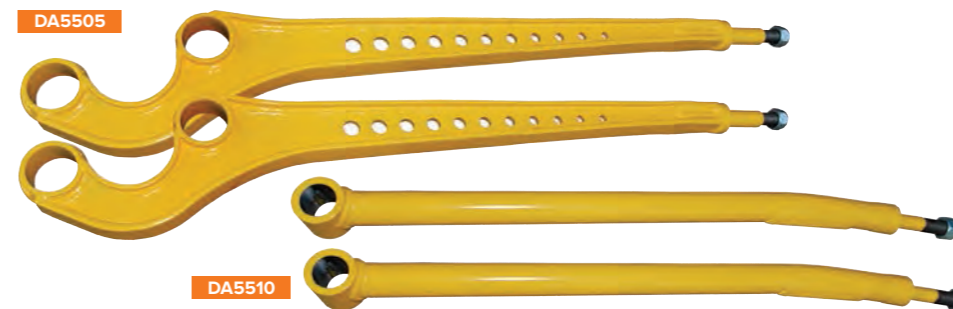

> Designed for Defender/Discovery 1/Range Rover Classic with an extended 1 to 3" lift.
> Front radius arms correct castor alignment which in turn ensures safe driving.
> Rear radius arms provide full rear axle articulation.
> Fitting the radius arms will contribute to much better off-road capability for your vehicle by fully utilising your spring and shock absorber set.
> Zinc passivated with a yellow heavy-duty powder coating finish to complement each component and the Britpart coil springs.

DA5505	3° Heavy-duty	Narrow	Use with NTC7307 & DA2353 bushes	38mm
DA5506	3° Heavy-duty	Wide	Use with NTC6781 & DA2353 bushes	45mm
DA5510	2" Lift rear	radius arm		

Suspension Arm & Bolt Kits



Have all the parts you need with one easy part number when you have to change a suspension arm. Kit contains suspension arm and bolts where applicable.*

Britpart Kit	OEM Kit	No Bushes or bolts*	Model	Position	Side
	RBJ500222GK NEW		Discovery 3	Front - upper	RHS
	RBJ500232GK NEW		Discovery 3	Front - upper	LHS
		RBJ500840NB NEW	Discovery 3 - heavy-duty	Front - upper	RHS
		RBJ500850NB NEW	Discovery 3 - heavy-duty	Front - upper	LHS
LR028245K	LR028245GK	LR028245NB	Discovery 3	Front - lower	RHS
LR028249K	LR028249GK	LR028249NB	Discovery 3	Front - lower	LHS
	LR051622GK NEW		Discovery 3	Rear - upper	RHS
	LR051623GK NEW		Discovery 3	Rear - upper	LHS
LR019979K NEW			Discovery 3	Rear - lower	RHS
LR019980K NEW			Discovery 3	Rear - lower	LHS
	RBJ500840NB NEW		Discovery 4 - heavy-duty	Front - upper	RHS
	RBJ500850NB NEW		Discovery 4 - heavy-duty	Front - upper	LHS
LR025610K	LR025610GK		Discovery 4	Front - lower	RHS
LR025613K	LR025613GK		Discovery 4	Front - lower	LHS
	LR051622GK NEW		Discovery 4	Rear - upper	RHS
	LR051623GK NEW		Discovery 4	Rear - upper	LHS
LR019979K NEW			Discovery 4	Rear - lower	RHS
LR019980K NEW			Discovery 4	Rear - lower	LHS
	RBJ500840NB NEW		Range Rover Sport - 2005 - 2009	Front - upper	RHS
			With ACE suspension		
	RBJ500850NB NEW		Range Rover Sport - 2005 - 2009	Front - upper	LHS
			With ACE suspension		
LR029303K	LR029303GK		Range Rover Sport - 2005 - 2009	Front - lower	RHS
LR029304K	LR029304GK	LR029304NB NEW	Range Rover Sport - 2005 - 2009	Front - lower	RHS
LR029305K	LR029305GK		Range Rover Sport - 2005 - 2009	Front - lower	LHS
LR029306K	LR029306GK	LR029306NB NEW	Range Rover Sport - 2005 - 2009	Front - lower	LHS

*Supplied with ball joint.



Suspension Bolt Kits



DA7202	Defender - up to KA930455	Front suspension - radius arms & panhard rod bolts
DA7200	Defender - LA930456 to WA159806	Front suspension - radius arms & panhard rod bolts
DA7203	Defender - XA159807 to 2A626645	Front suspension - radius arms & panhard rod bolts
DA7204	Defender - 2A625546 onwards	Front suspension - radius arms & panhard rod bolts
DA7201	Defender - up to YA185790	Rear suspension - trailing arms & a-frame bolts
DA7208	Defender - YA185791 onwards	Rear suspension - trailing arms & a-frame bolts
DA7212 NEW	Discovery 3/Discovery 4/Range Rover Sport - 2005 - 2012	Front upper suspension arm
DA7205	Discovery 3/Discovery 4/Range Rover Sport - 2005 - 2012	Front lower suspension arm
DA7207	Discovery 3/Discovery 4/Range Rover Sport - 2005 - 2012	Rear upper suspension arm
DA7206	Discovery 3/Discovery 4/Range Rover Sport - 2005 - 2012	Rear lower suspension arm

Note - This kit includes a 15mm pitch threaded nut, please check the thread pitch on your drive shaft before changing. If you require the 2mm pitch nut please order LR024151.



Photo courtesy of David Priddis

Brackets, Mounts & Ancillary Products

Shock Absorber Brackets & Turrets

Sometimes off-road conditions can be serious enough to test the standard equipment on your Land Rover...



DA1186



Defender/Discovery 1 Range Rover Classic
DA1186
 Galvanised standard height front shock turrets with fitting kit.
NRC6372GALV NEW
 Galvanised standard height front shock turret - single
NRC9700GALV NEW
 Galvanised spring seat - single

DA1164
 Heavy-duty, plus 30mm, front turrets for Discovery 2. Finished in heavy-duty powder coating. Complete with nuts and bolts.



DA6322L



Kit includes nuts, bolts & washers



DA6323L



DA6322	Defender/Discovery 1/Range Rover Classic*	Twin shock turrets	Front	Standard height
DA6322L	Defender/Discovery 1/Range Rover Classic*	Twin shock turrets	Front	2" Lift
DA6323	Defender/Discovery 1/Range Rover Classic*	Single shock turrets	Front	Standard height
DA6323L	Defender/Discovery 1/Range Rover Classic*	Single shock turrets	Front	2" Lift
DA6324	Defender/Discovery 1/Range Rover Classic*	Twin shock brackets - kit	Rear	

Sometimes off-road conditions can be serious enough to test the standard equipment on your Land Rover to its maximum. One of the critical components that takes most of the abuse is the suspension system. When using the standard single shock absorber configuration it is not unknown for the shock absorber to break the factory fitted turret mount. These shock absorber turrets from Britpart give you confidence that your vehicles suspension will tackle the terrain you take it through with greater ease.

The single shock absorber turret is manufactured from heavy-duty steel and replaces the existing turret mount which is susceptible to corrosion by allowing a build up of dirt inside which is hard to clean thoroughly. The new design is harder wearing and easier to clean.

The twin shock absorber turret is manufactured from the same quality steel as the single shock absorber turret but allows for the fitment of an additional shock absorber. The benefits of having extra shock absorbers fitted to your Land Rover is that any extreme force encountered is divided between the two shock absorbers for a more comfortable ride for you and your passengers. Using twin shocks is also beneficial when carrying loads both on and off-road as it improves the load carrying ability of the vehicle. An additional benefit is that when changing shock absorbers there is no need to remove the turrets.

*Note - Rear brackets involve some welding to fit. Fitting shock absorber brackets may require some vehicle modification, please ask distributor for full details.

DA6337



DA6337
 Defender/Discovery 1/Range Rover Classic*
 Long travel rear shocker absorber mounting kit

The standard pin and eye shock absorbers don't have the necessary articulation for extreme off road conditions and the answer is to use pin and pin shock absorbers. If you use our Cellular Dynamic Plus 5 shock absorbers they offer better articulation. Laser cut, jigged and computer welded with zinc plated and powder coated finish. To be used in conjunction with DC6000LL. **Note** - On Defender Td5 the fuel filter must be moved.

Adjustable Ball Joint



ANR1799A
 Defender/Discovery 1/Range Rover Classic
 An adjustable A-frame ball joint
 Single

Dislocation Cones



These clever products ensure your springs relocate correctly when using your Land Rover in extreme conditions. Manufactured from stainless steel. Use in conjunction with spring retainers.
DA2186 Defender 90/Discovery 1 Rear Pair
DA1962 Defender 110 Rear Pair

Rear Spring Seats

Galvanised rear spring seat fitting kits
DA1215
 Defender - 90
 Discovery 1
 Range Rover Classic
DA1233
 Defender - 110 & 130
NRC9700GALV NEW
 Galvanised spring seat - single

Spring Retainers

DA2363
 In some situations the vehicle's springs can get dislodged from their seating, these heavy-duty spring retainers ensure the springs are kept in the correct position.
 Defender
 Discovery 1
 Range Rover Classic
DA2362 Front
DA2363 Rear

Turret Rings

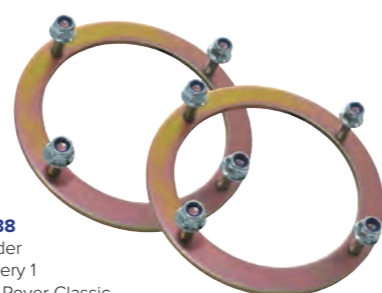

DA6338
 Defender
 Discovery 1
 Range Rover Classic
 These robust & heavy-duty front shock absorber turret rings are made to replace the existing standard turret rings.

Spring Spacer Blocks



Defender/Discovery 1/Range Rover Classic
 These 50mm spring spacer blocks are manufactured from 6mm plate with a powder coated finish. The spacers fit between the axle and the spring seats on the front and rear to give you that extra 50mm of lift you need.
DA6344 Front pair
DA6345 Rear pair

Discovery 2
 These 40mm spring spacer blocks are machined from high quality aluminium and anodised deep blue.
DA6341 Front pair
 With this kit you are able to retain the standard springs and shock absorbers. Use in conjunction with DA6342.
DA6342 Rear pair

Lift Rod Kit



DA7531
 Discovery 3/Discovery 4/Range Rover Sport - 2005 - 2013
 These adjustable rods replace the plastic and rubber parts Land Rover supply on the vehicle. Made from aluminium with an industrial heavy grade rubber bushing, the aluminium parts are anodised black to help with corrosion protection and blending in when in the garage for work.
 The lift rods have two settings; standard and off-road. With the vehicle set to normal driving height the shortened rods will give you off-road height. If you select off-road height the vehicle will be in the 'super extended' position as standard if you use the 'shortened' settings. The ease of changing the ride height is what separates these rods from others in the marketplace.
 No tools are required and should take no more than 2 minutes to do all four rods. Access to the front is over the front wheels and for the back is through the rear wishbones (blanket required!)
Note - If run for a long time in off-road position then wheels may need realigning.



Bushes

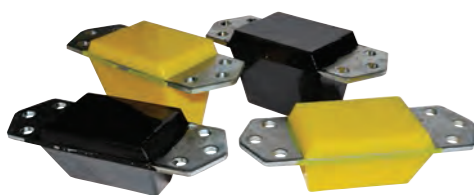

Defender & Discovery 1	Front	Standard	Black
ANR4188PY	Front	Standard	Black
ANR4188PY-YELLOW	Front	Standard	Yellow
ANR4189PY	Rear	Standard	Black
ANR4189PY-YELLOW	Rear	Standard	Yellow
ANR4188PYE	Front	Extended	Black
ANR4188EYELLOW	Front	Extended	Yellow
ANR4189PYE	Rear	Extended	Black
ANR4189EYELLOW	Rear	Extended	Yellow

Note - All sold individually. Standard height - 56mm high. Extended height - 80mm high.

Bump Stops



Extended polyurethane bump stops should be used on vehicles with raised suspension to prevent the shock absorbers from bottoming out.

Discovery 2	Front/Rear	Standard	Black
DC7112	Front/Rear	Standard	Black
DC7012	Front/Rear	Standard	Yellow
DC7113	Front/Rear	Extended	Black
DC7013	Front/Rear	Extended	Yellow

Note - Set of 4 stops. Standard height - 60mm high. Extended height - 90mm high.

Bush Fitting Tool



LRT-60-004
Fitting new front radius arm bushes (part number ANR3332) for the Range Rover P38A is impossible to do without using the Land Rover special tool.

Bush Set - Watts Linkage



RGX100960K
Discovery 2
Watts rear linkage bush set contains bushes to replace centre bearing, top & bottom bush links and axle end links.



DA1199
Discovery 2
This replacement pivot for the rear suspension is complete with bushes fitted which makes an awkward job easier.

Bush Sets - Castor Correction



Defender/Discovery 1/Range Rover Classic Old Man Emu replacement bushes to correct the castor angle after a Land Rover has been lifted. These will ensure the correct steering geometry is maintained.
DA8952 NEW Narrow bush - 38mm
DA8951 NEW Wide bush - 44mm

Bush Sets - Britpart Polyurethane

Britpart Individual Polyurethane Bush Sets	
548205PY	Shackle & spring
548205PY-YELLOW	Shackle & spring
552818PY	Shock absorber
552818PY-YELLOW	Shock absorber
552819PY	Shock absorber
552819PY-YELLOW	Shock absorber
568858PY	Steering damper
568858PY-YELLOW	Steering damper
569746PY	Rear chassis
569746PY-YELLOW	Rear chassis
572068PY	Radius arm to chassis - outer
572068PY-YELLOW	Radius arm to chassis - outer
572180PY	Bottom link to chassis
572180PY-YELLOW	Bottom link to chassis
575580PY	Panhard rod
575580PY-YELLOW	Panhard rod
90577434PY	Rear chassis
90577434YELLOW	Rear chassis
ANR1721PY	Damper mounting
ANR1721PY-YELLOW	Damper mounting
ANR2563PY	Radius arm to chassis
ANR2563PY-YELLOW	Radius arm to chassis
ANR3285PY	Trailing arm rear suspension
ANR3285PY-YELLOW	Trailing arm rear suspension
ANR3305PY	Anti-roll bar
ANR3305PY-YELLOW	Anti-roll bar
ANR3332PY	Radius arm to axle
ANR3332PY-YELLOW	Radius arm to axle
ANR3410PY	Panhard rod
ANR3410PY-YELLOW	Panhard rod
ANR6947PY	Radius arm to axle
ANR6947PY-YELLOW	Radius arm to axle
NRC4514PY	Radius arm to chassis
NRC4514PY-YELLOW	Radius arm to chassis
NRC5593PY	Damper mounting
NRC5593PY-YELLOW	Damper mounting
NTC1772PY	Lower arm
NTC1772PY-YELLOW	Lower arm
NTC1773PY	Upper link
NTC1773PY-YELLOW	Upper link
NTC1775PY	Steering damper
NTC1775PY-YELLOW	Steering damper
NTC6781PY	Radius arm to axle
NTC6781PY-YELLOW	Radius arm to axle
NTC6860PY	Radius arm to axle
NTC6860PY-YELLOW	Radius arm to axle
NTC6828PY	Anti-roll bar
NTC6828PY-YELLOW	Anti-roll bar
NTC7307PY	Radius arm to axle
NTC7307PY-YELLOW	Radius arm to axle
NTC7394PY	Anti-roll bar
NTC7394PY-YELLOW	Anti-roll bar
RBX101240PY	Anti-roll bar
RBX101240YELLOW	Anti-roll bar
RBX101340PY	Panhard rod
RBX101340YELLOW	Panhard rod
RBX101680PY	Radius arm to chassis
RBX101680YELLOW	Radius arm to chassis
RBX101690PY	Anti-roll bar
RBX101690YELLOW	Anti-roll bar

RBX101730PY	Radius arm to chassis & axle
RBX101730YELLOW	Radius arm to chassis & axle
RBX101780PY	Lower arm
RBX101780YELLOW	Lower arm
RBX101790PY	Lower arm
RBX101790YELLOW	Lower arm
RDB100080PY	Lower arm control buffer
RDB100080YELLOW	Lower arm control buffer
RGX100970PY	Transverse link
RGX100970YELLOW	Transverse link
RGX101000PY	Trailing link
RGX101000YELLOW	Trailing link
RGX101010PY	Hub
RGX101010YELLOW	Hub
RGX101020PY	Bottom link - outer
RGX101020YELLOW	Bottom link - outer
RGX101440PY	Bottom link - inner
RGX101440YELLOW	Bottom link - inner
RNF100090PY	Shock absorber - lower
RNF100090YELLOW	Shock absorber - lower
ROA100040PY NEW	Shock absorber - lower
ROA100050PY NEW	Shock absorber - upper
STC618PY	Mounting lower link
STC618PY-YELLOW	Mounting lower link

Note - Part numbers without yellow as a suffix indicate the bush colour is black.

All bushes are manufactured using the latest Vulkollan™ polyurethane technology.

Britpart Black Suspension Bush Sets	Britpart Yellow Suspension Bush Sets
DC7103 Series 1, 2 & 3 - excluding 3 LWB (see DC7104)	DC7003 Series 1, 2 & 3 - excluding 3 LWB (see DC7004)
DC7104 Series 3 - LWB	DC7004 Series 3 - LWB
DC7109 Defender - up to 1993	DC7009 Defender - up to 1993
DC7110 Defender - 1994 - 1999	DC7010 Defender - 1994 - 1999
DC7108 Defender - 1999 - 2007	DC7008 Defender - 1999 - 2007
DC7111 Defender - 2007 onwards - up to 9A766382	DC7011 Defender - 2007 onwards - up to 9A766382
DA2426 Defender - steering damper bush set	DA2425 Defender - steering damper bush set
DC7100 Discovery 1	DC7000 Discovery 1
DC7101 Discovery 2/**	DC7001 Discovery 2/**
DC7102 Freelander 1	DC7002 Freelander 1
DC7105 Range Rover Classic - up to 1986	DC7005 Range Rover Classic - up to 1986
DC7106 Range Rover Classic - 1986 - 1994	DC7006 Range Rover Classic - 1986 - 1994
DC7107 Range Rover P38**	DC7007 Range Rover P38**



Bush Sets - Polybush

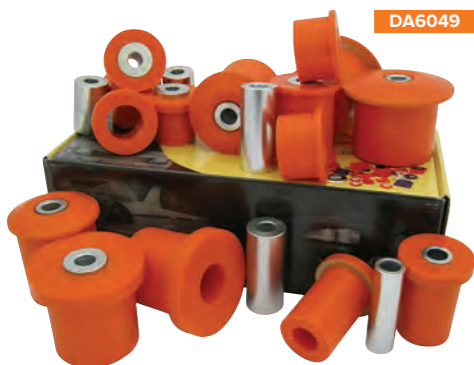

DA3144
Full Polybush Dynamic Orange kit
Discovery 3 & Discovery 4
Kit contains -
Front lower wishbone - front & rear bushes; front upper wishbone bushes; rear lower wishbone - front & rear bushes; rear upper wishbone - front & rear bushes

Individual Polybush Dynamic Orange kits	
Discovery 3 & Discovery 4	
RBX000571PY	Front anti-roll bar clamp kit
RGX500060PY	Rear anti-roll bar clamp kit
RBX500301PY	Front upper wishbone kit
LR056964PY	Front upper wishbone kit
RBX500311PY	Front lower wishbone - front kit
LR051585PY	Front lower wishbone - front kit
RBX500291PY	Front lower wishbone - rear kit
LR025159PY	Front lower wishbone - rear kit
LR051586PY	Front lower wishbone - rear kit
RGX500101PY	Rear lower wishbone - front kit
RGX500290PY	Rear lower wishbone - front kit
RGX500111PY	Rear lower wishbone - rear kit
LR054831PY	Rear lower wishbone - rear kit
RGX500121PY	Rear upper wishbone - rear kit
RGX500300PY	Rear upper wishbone - front kit
LR051621PY	Rear upper wishbone - front kit
ROA000022PY	Damper kit



DA2220	Polybush Classic Red Suspension bush set - wide bushes Defender 90 & 110 - 1994 onwards Discovery 1 Range Rover Classic - 1986 onwards Kit contains - Axle - front radius arm/rear radius arm & panhard rod. Chassis - front radius arm & rear radius arm
DA2198	Defender 2002 on Red Kit contents - Front radius arm/axle; front radius arm/chassis; panhard rod; rear radius arm/axle; rear radius arm/chassis
DA2204	Discovery 2 Orange Dynamic Kit contents - Front radius arm to axle; front radius arm to chassis; front panhard rod; rear axle - watts link to chassis bush; rear radius arm to chassis; rear radius arm to axle
DA2200	Freelander 1 Orange Dynamic Kit contents - Anti roll bar clamp; rear radius arm to chassis; rear radius arm to hub carrier; rear lower wishbone rear arm - inner and outer and front arm outer; rear lower wishbone front arm inner; front wishbone front bush; front lower wishbone - rear bush; front lower wishbone - rear retaining washer
DA2203	Range Rover P38 1994 on Blue Comfort Kit contents - Front radius arm to axle; front radius arm to chassis; panhard rod; rear radius arm to chassis



facebook.com/britpart



Bush Sets - Britpart



Polyurethane Bush Sets
DA4035BLUE
 Defender - 90/110/130 - up to 1993 with drum brakes
DA4036BLUE
 Defender - 1994 onwards
 Discovery 1
 Range Rover Classic - 1986 onwards



Rubber Bush Set
 Front radius arm to chassis kit
 Defender - 1987 - 1997/Discovery 1/
 Range Rover Classic - 1986 - 1994
DA2353 - Britpart
DA2353G - OEM

Bush Sets - Powerflex NEW



LR025159PF NEW
LR051586PF NEW
RBX500291PF NEW
LR051585PF NEW
RBX500311PF NEW

Discovery 3/Discovery 4	Front arm - lower - rear
Discovery 3/Discovery 4	Front arm - lower - front

- > Better handling
- > Better stability under braking
- > Prolong tyre life
- > High quality polyurethane material
- > Last longer (up to 10 x rubber equivalent)
- > Easily fitted

Powerflex bushes offer improved performance, safety and prolong tyre life. Engineered to be the best, Powerflex bushes are an answer to soft ageing and failing rubber suspension bushes and provide improved suspension mountings. No special tools are needed and comprehensive fitting instructions are included.



Photo courtesy of Sandra Rimmer

Shock Absorbers

BRITPART XD

Britpart have developed this range of remote reservoir shock absorbers for users wanting the extra benefits of a remote reservoir shock absorber on a vehicle that is used both on and off-road. The remote reservoir allows the shock to remain cooler under more extreme conditions and hence reduces the possibility of fade. Unlike most remote reservoir shock absorbers on the market the Britpart XD remote reservoir shock absorbers use conventional rubber bushings instead of ball joints. This is because ball joints have a very short life span when used on a road vehicle and are more suited to an all out competition vehicle.



Britpart XD Remote Reservoir

Nitrogen filled remote reservoir shock absorbers with zinc plated steel body and anodised fittings.
Note - Will require extra fabrication to fit.
 Defender 90 & 110/Discovery 1/Range Rover Classic

Body diameter - 51mm
 Shaft diameter - 20mm
 Hydraulic hose length - 600mm

		Open length	Closed length
DC8000	Front pair	716mm	462mm
DC8001	Rear pair	717mm	463mm

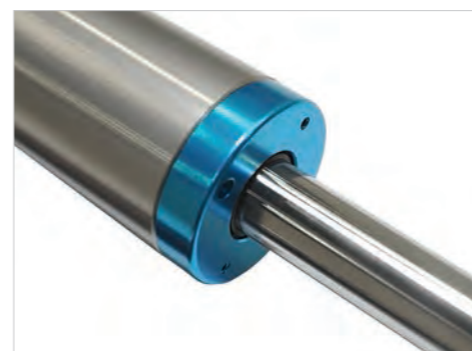

Air Suspension Compressors



At last, a cost effective and easy way to replace the OE air suspension compressor. These compressors are a direct replacement fit for the OE compressors that were fitted by the factory. They are made in Japan by Hitachi. By using the original brackets and pipes they are easy to install. The relay, which is included, must be changed. No need to reprogram the ECU (fault codes may need to be cleared).

- > Direct replacement fit
- > Cost effective
- > No need to reprogram the air suspension ECU
- > Uses all original mounting & pipework

DA3965 NEW Complete compressor kit
 Discovery 3 - up to 9A513325
 Range Rover Sport - up to 9A215622
LR023964 - compressor & relay
RQU500064 - compressor bracket
DA3964 - compressor pipe/install kit
 Plus - bolts, nuts, clips & mounting rubbers
LR015303 & LR023964 Compressor & relay
 Discovery 3 - up to 9A513325
 Range Rover Sport - up to 9A215622
LR015089 & LR025111 Compressor & relay
 Range Rover L322 - from 6A198058 up to CA393639
DA3964 NEW Hitachi compressor pipe/install kit



LR025111



DA3964



LR023964



LR072537



LR078650



LR045444

Britpart Heavy-Duty

Heavy-duty oil filled shock absorbers

DA4211	Defender 90/110	Front
DA4210	Defender 90/110	Rear
RTC4234	Series 2/2A/3 - SWB	Front
RTC4235	Series 2/2A/3 - SWB	Rear
RTC4484	Series 2/2A/3 - LWB	Front
RTC4236	Series 2/2A/3 - LWB	Rear



NEW Sign up to the regular Britpart newsletter to find out about all the latest product releases.
www.britpart.com/newsletter

Britpart Cellular Dynamic

Application	Lift	Fitment	Open/Closed Dimensions**
DC6000 Defender/Discovery 1/Range Rover Classic		Front	600/380mm
DC6001 Defender/Discovery 1/Range Rover Classic		Rear	590/375mm
DC6000L Defender/Discovery 1/Range Rover Classic	50mm/2"	Front	665/425mm
DC6001L Defender/Discovery 1/Range Rover Classic	50mm/2"	Rear	625/385mm
DC6000LL Defender/Discovery 1/Range Rover Classic	125mm/5" (see note***)	Front	765/455mm
DC6001LL Defender/Discovery 1/Range Rover Classic	125mm/5" (see note***)	Rear	750/440mm
DC6010 Discovery 2		Front	590/370mm
DC6011 Discovery 2		Rear	585/365mm
DC6002 Range Rover P38 - air suspension		Front	560/365mm
DC6003 Range Rover P38 - air suspension		Rear	505/340mm
DC6004 Defender		Steering Damper	
DC6005 Discovery 1/Range Rover Classic/Series		Steering Damper	
DC6009 Discovery 2		Steering Damper	
DC6006 Range Rover P38		Steering Damper	
DC6007 Replacement gaiter for DC6000LL & DC6001LL - single			



> Cellular technology tube
 > Sintered 18mm rod
 > Piston diameter 41mm
 > Polyurethane bush
 > Teflon piston with multi-lip seal
 > Single piece eye ring

The Britpart Cellular Dynamic Shock Absorber represents a significant advance in Land Rover suspension systems. It features a cellular foam insert instead of a normal nitrogen gas or air, this is to stop the oil from boiling. The foam takes up less room which means more room for oil, 50% more, which offers maximum heat dispersion. This heat dispersion translates to a very subtle but controlled ride that will not fade no matter how hard you push them. They are ideal for a driver who needs more control to complement performance improvements or to enhance a standard vehicle. The unique design ensures ride comfort and cornering ability is maximised and of course they are superb off-road.

Notes
 *Terms & conditions apply
 ** Dimensions are +/- 5mm
 *** The Plus 5" Cellular Dynamic Shock Absorbers are specialist suspension products and to install them additional fabrication work or brackets may be required. Please ensure that they are fitted by a competent expert.



DC6001LL

"They are ideal for a driver who needs more control to complement performance improvements"

Britpart Super Gaz

Application	Lift	Fitment	Open/Closed Dimensions**
DC5002 Defender/Discovery 1/Range Rover Classic		Front	605/385mm
DC5003 Defender/Discovery 1/Range Rover Classic		Rear	590/375mm
DC5002L Defender/Discovery 1/Range Rover Classic	50mm/2"	Front	655/405mm
DC5003L Defender/Discovery 1/Range Rover Classic	50mm/2"	Rear	640/400mm
DC5000 Discovery 2		Front	590/370mm
DC5001 Discovery 2		Rear	585/365mm
DC5000L Discovery 2	50mm/2"	Front	640/400mm
DC5001L Discovery 2	50mm/2"	Rear	635/390mm
DC5004 Defender		Steering damper	
DC5005 Discovery 1/Range Rover Classic/Series		Steering damper	



"Vast improvement in ride quality & damping performance"

24 month / 50,000 mile Warranty



Bilstein NEW



Bilstein rear shock absorbers
 Range Rover L322 - 2010 - 2012
LR023573 NEW Right hand assembly
LR023580 NEW Left hand assembly

Delphi De Carbon

Shock Absorbers
DA4162 Series - LWB/SWB
DA4181 Defender - up to 1999
 Discovery 1 - to 1994
 Range Rover Classic
Note - Boxed as a pair, priced individually



Old Man Emu NEW

Application	Fitment	Open/Closed Dimensions
DA8911 NEW Defender - 90, 110 & 130	Front	553/329mm
DA8921 NEW Defender - 90 & 110	Rear	560/346mm
DA8913 NEW Defender - 90 & 110	Rear - heavy-duty	560/346mm
DA8913 NEW Defender - 130	Rear	560/346mm
DA8911 NEW Discovery 1	Front	553/329mm
DA8921 NEW Discovery 1	Rear	560/346mm
DA8913 NEW Discovery 1	Rear - heavy-duty	560/346mm
DA8916 NEW Discovery 2	Front	587/368mm
DA8917 NEW Discovery 2	Rear	587/368mm
DA8911 NEW Range Rover Classic	Front	553/329mm
DA8921 NEW Range Rover Classic	Rear	560/346mm
DA8913 NEW Range Rover Classic	Rear - heavy-duty	560/346mm



Nitrocharger Sport shock absorbers introduces advanced dual-stack deflective disc technology that continuously adapts to the terrain, offering rapid response improvements to ride quality, handling and control. Available in the UK only.

- Features**
- > Interactive, multi-stacked rebound and compression valving systems ensure optimal damping performance in all conditions.
 - > Vehicle specific fine tuning for superior handling and ride performance.
 - > Piston rod "slip ring" provides more consistent and uniform damping performance.
 - > Triple lipped oil seal with gas retention check valve design virtually eliminates contaminant damage and gas loss.



Photo courtesy of David Rogers

Springs



Air Lift Kits

Adjustable Air Helper Springs - The load and towing problem solver

Air adjustability is the difference! Stiff steel factory suspensions must compromise between ride comfort and load hauling capacity. Smooth ride suspensions can't carry heavy loads; heavy springs ride rough, especially when the vehicle is unloaded. Air Lift adjustable air springs solve these problems by allowing you to tune your suspension under all load and road conditions. Just add air when towing or hauling and then remove air for a softer ride when unloaded.

Features & benefits of Air Lift 1000

- > Improve ride, handling and stability by reducing roll, sway and "bottoming out"
- > Fits open coil springs, front or rear
- > Up to 1,000lbs of levelling capacity
- > Tough long-lasting moulded polyurethane construction
- > Quick connecting easy-to-use engineered polymer air fittings

DA5010
Defender 110 /130
DA5011
Defender 90/Discovery 1/Range Rover Classic



DA5012
Load Controller II
The economical, popular, basic on board air system. This system controls the rear bags equally. All kits include wiring harness for fast, easy installation. To eliminate the major cause of air spring failure, the low pressure sensor automatically activates if pressure falls below the minimum safe level.



Leaf Spring Castor Correction Wedges

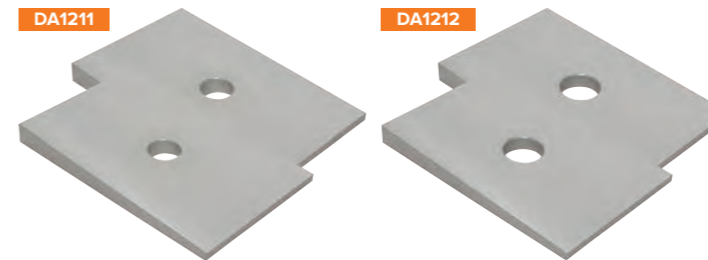

DA1211
Castor correction wedges - pair
Small pin - 13mm
DA1212
Castor correction wedges - pair
Large pin - 16mm

Can be used to correct castor or diff pin angle on leaf sprung vehicles by 3 degrees.



Old Man Emu NEW

- > Manufactured from state of the art micro-alloyed spring steel for superior strength and durability.
- > Double scragged before and after shot peening to reduce spring stress and enhance spring life.
- > Exceptional resistance to sagging and corrosion.
- > Springs are designed for each vehicle to match the spring to the specific applications.
- > Springs formed on computer controlled, precision mandrels to ensure manufacturing consistency.
- > Spring end configurations designed to exact specifications, guaranteeing perfect fitment to your vehicle.
- > Durable, hard wearing black powder coat.
- > Designed and manufactured in Australia.

Notes

Caution - Due to altered gearbox mounts on models after 1998 any lift above OE ride height may cause front driveline vibration that can only be rectified by fitting of a front double cardan propshaft. On vehicles fitted with an OE inner helper coil such as fitted to some 110 and 130 models. The inner coil must be retained with Old Man Emu coils. Important: DA8922 has reduced spring rate from OE to provide improved ride quality for light loads. Available in the UK only.



Springs - Air



Air springs can be susceptible to air leaks due to the fact the rubber seals dry out. Why not firm up your suspension and replace them with these quality air springs from Britpart?

RKB101200	Discovery 2	Rear
NTC9819G	Range Rover Classic	Front
NTC9820	Range Rover Classic	Rear
DA2372	Range Rover P38	Front
DA2373	Range Rover P38	Rear
REB101740	Range Rover P38	Front
RKB101460	Range Rover P38	Rear

Note - All sold individually.

Springs - Leaf

For many years Land Rover road springs have been difficult to obtain to the correct OE specification. To remedy this, Britpart commissioned the same Spanish factory that produces our Santana parabolic springs to reproduce a comprehensive range of springs for Land Rover Series vehicles. The springs are constructed from the correct grade alloy steel 60SiCr8, heat treated consisting of hardening & tempering and set as Land Rover engineers specified and therefore will give years of service with the correct ride comfort.

241283	SWB	Petrol	Front	9 Leaf	O/S
242863	SWB	Petrol	Front	9 Leaf	N/S
265627	SWB & LWB	Diesel	Front	11 Leaf	O/S
264563	SWB & LWB	Diesel	Front	11 Leaf	N/S
517588	SWB		Rear	11 Leaf	O/S
517589	SWB		Rear	11 Leaf	N/S
243123	SWB		Rear	Single main leaf	O/S & N/S
279678	LWB		Rear	10 Leaf	O/S
279679	LWB		Rear	10 Leaf	N/S
535173	LWB - 1 Ton		Rear	9 Leaf	O/S & N/S
562631	Lightweight		Rear	7 Leaf	O/S
562632	Lightweight		Rear	7 Leaf	N/S



"Quality you would expect from an OEM supplier..."

Springs - Parabolic

The Britpart range of high quality OEM parabolic springs are made to the exacting specifications as fitted to Santana specification vehicles. Manufactured in Spain to the standard and quality you would expect from an OEM supplier. The correct grade alloy steel 60SiCr8 is used, heat treated consisting of hardening & tempering and springs are shot peened before painting. These parabolic springs will bring a comfortable ride and improved handling to your Series vehicle.

Note - Includes 'U' bolts and nuts.

DA4106	Series - SWB/LWB	2 Leaf	Front kit pair
DA4107	Series - SWB	3 Leaf	Rear kit pair
DA2003	Series - LWB	4 Leaf	Rear kit pair

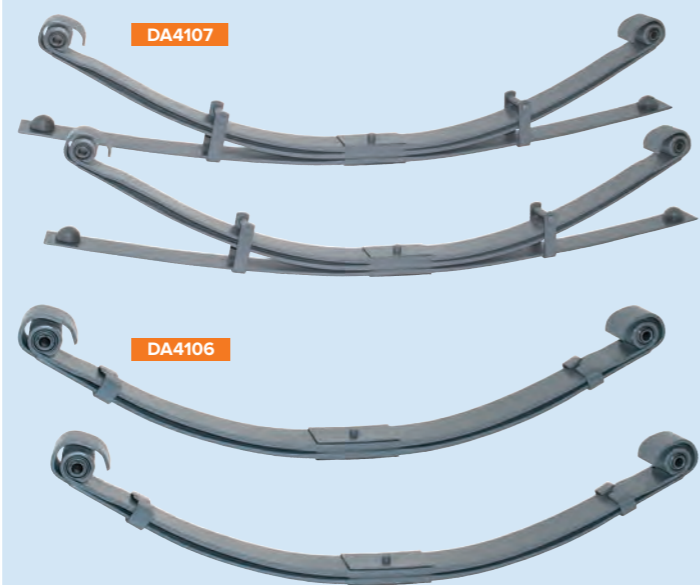

Defender			Load	Lift	lbf/in	Spring Rate N/mm	Free Height
DA8910 NEW	Defender - 90/110/130 - diesel	Front	50kg	Up to 40mm	225	39	390mm
DA8924 NEW	Defender - 90 - diesel	Front	51 - 110kg	Up to 40mm	285	50	385mm
DA8914 NEW	Defender - 90/110 - petrol	Front	50kgs	Up to 40mm	200	35	400mm
DA8910 NEW	Defender - 90/110 - petrol	Front	51 - 110kg	Up to 40mm	225	39	390mm
DA8920 NEW	Defender - 90	Rear	100kg	Up to 40mm	220	39	430mm
DA8912 NEW	Defender - 90	Rear	200kg	Up to 40mm	300/340	52/60	420mm
DA8922 NEW	Defender - 110	Rear	300kg	Up to 50mm	300	52	435mm
DA8923 NEW	Defender - 110	Rear	500kg	Up to 55mm	420	74	435mm
DA8922 NEW	Defender - 130	Rear	Light Load	Up to 50mm	300	52	435mm
DA8923 NEW	Defender - 130	Rear	400kg	Up to 55mm	420	74	435mm

Discovery							
DA8910 NEW	Discovery 1 - diesel	Front	50kg	Up to 40mm	225	39	390mm
DA8914 NEW	Discovery 1 - petrol	Front	50kg	Up to 40mm	200	35	400mm
DA8924 NEW	Discovery 1	Front	51 - 110kgs	Up to 40mm	285	50	385mm
DA8920 NEW	Discovery 1	Rear	Medium	Up to 40mm	220	39	430mm
DA8912 NEW	Discovery 1	Rear	100kg	Up to 40mm	300/340	52/60	420mm
DA8915 NEW	Discovery 2	Front	21 - 50kg	Up to 40mm	180	32	395mm
DA8912 NEW	Discovery 2	Rear	100kg	Up to 40mm	300/340	52/60	420mm
DA8918 NEW	Discovery 3	Front	Standard	Up to 50mm	530	93	400mm
DA8919 NEW	Discovery 3	Rear	Medium	Up to 50mm	680	119	370mm

Range Rover							
DA8910 NEW	Range Rover Classic - diesel	Front	50kg	Up to 40mm	225	39	390mm
DA8914 NEW	Range Rover Classic - petrol	Front	50kg	Up to 40mm	200	35	400mm
DA8924 NEW	Range Rover Classic	Front	51 - 110kg	Up to 40mm	285	50	385mm
DA8920 NEW	Range Rover Classic	Rear	Medium	Up to 40mm	220	39	430mm
DA8912 NEW	Range Rover Classic	Rear	100kg	Up to 40mm	300/340	52/60	420mm

Springs - Lowered Coils & Kit

Reduce the ride height of your Land Rover by 1" (25mm). By lowering your vehicle it will help reduce body roll as well as giving your vehicle a more sporty squat stance and improve handling. The springs are designed in line with the standard spring rate specification and are finished in powered coated orange paint to match the anti-roll bars and shock absorbers.

DA4563
Defender 90/110
Discovery 1
Range Rover Classic
Front springs
Pair
DA4564
Defender 90
Discovery 1
Range Rover Classic
Rear springs
Pair
DA6449 NEW
Defender 110
Rear springs
Pair



DA1234
XD Handling Kit
Defender 90 / Discovery 1
Range Rover Classic with axle brackets

- Kit contains -
- > Britpart lowered coil springs
- > Britpart Cellular Dynamic shock absorbers
- > Anti-roll bars
- > Turret rings
- > Straps
- > Ball joint assemblies
- > Bushes
- > Nuts, bolts and washers

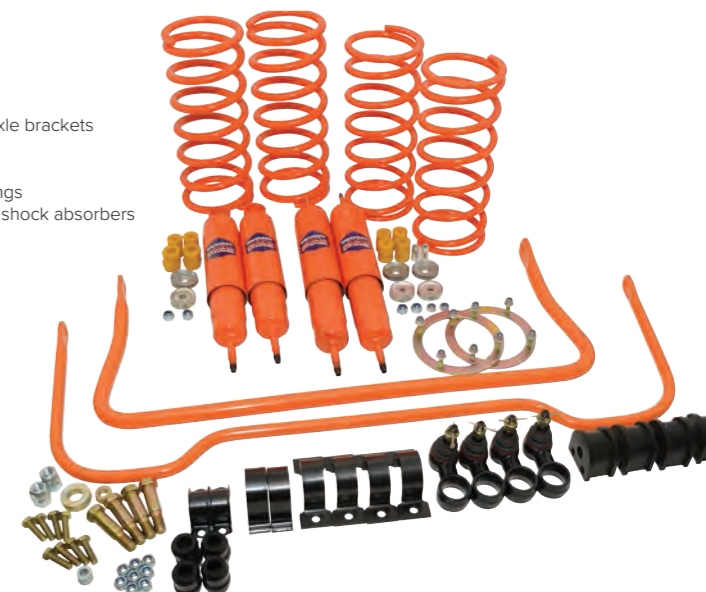

Springs - Britpart Coil



Britpart Performance - Lifted Springs

Britpart performance springs are high quality, versatile and competitively priced - the right choice when replacing the old sagging original springs.

Developed by one of the world's top spring manufacturers these high quality, powder coated yellow springs have been designed with the needs of today's Land Rover owners in mind. Britpart performance lifted springs have the added benefit of improving your vehicles approach and departure angles which in turn allows you to overcome more obstacles when off-roading.

As Land Rovers are often working vehicles as well as the family car, uprated springs must offer the ability to carry loads, handle off-road terrain and provide a good ride on road. The progressive springs offer a compliant ride when lightly loaded, but firm up as the load increases.

Note - Spring quantity 1 = 1 pair

The right choice when replacing the old sagging original springs!

Defender			Lift	Load	Bar Diameter	Rate lbs/in	Free Height
DA4201	Defender 90/110	Front	25mm	25kg	16mm	200	420mm
DA4202	Defender 90/110/130	Front	40mm	50kg	16mm	230	390mm
DA4203	Defender 90	Rear	40mm	Light	17mm	220	435mm
DA4204	Defender 90	Rear	50mm	100kg	18mm	300 - 340	425mm
DA4205	Defender 90	Rear	50mm	200kg	19mm	360	430mm
DA4206	Defender 110	Rear	40mm	100kg	17mm	270 - 295	445mm
DA4208	Defender 110/130	Rear	50mm	500kg	21mm	420	445mm

Discovery			Lift	Load	Bar Diameter	Rate lbs/in	Free Height
DA4201	Discovery 1	Front	25mm	25kg	16mm	200	420mm
DA4202	Discovery 1	Front	40mm	50kg	16mm	230	390mm
DA4199	Discovery 2	Front	40mm	20 - 50kg	15mm	180	390mm
DA4198	Discovery 2	Front	40mm	50 - 100kg	16mm	220	390mm
DA4203	Discovery 1/Discovery 2	Rear	40mm	Light	17mm	220	435mm
DA4197	Discovery 2	Rear	40mm	Medium	18mm	290	430mm
DA4204	Discovery 1	Rear	50mm	100kg	18mm	300 - 340	425mm
DA4205	Discovery 1/Discovery 2	Rear	50mm	200kg	19mm	360	430mm

Range Rover			Lift	Load	Bar Diameter	Rate lbs/in	Free Height
DA4201	Range Rover Classic	Front	25mm	25kg	16mm	200	420mm
DA4202	Range Rover Classic	Front	40mm	50kg	16mm	230	390mm
DA4203	Range Rover Classic	Rear	40mm	Light	17mm	220	435mm
DA4204	Range Rover Classic	Rear	50mm	100kg	18mm	300 - 340	425mm
DA4205	Range Rover Classic	Rear	50mm	200kg	19mm	360	430mm

Britpart Performance - Standard Height Springs

Britpart yellow springs are designed for the enthusiast who wants a performance spring without having to raise the vehicle. They offer a firmer ride with less body roll, ideal for a vehicle with uprated performance or one used for carrying heavy loads. The springs are designed to offer full articulation off-road with a compliant ride. Developed by one of the world's top spring manufacturers these high quality, powder coated yellow springs have been designed with the needs of today's Land Rover owners in mind.

Note - Spring quantity 1 = 1 pair

Defender			Bar Diameter	Rate lbs/in	Free Height
DA4277	Defender 90/110	Front	16mm	225	390mm
DA4278	Defender 90	Rear	18mm	285	385mm
DA4279	Defender 110	Rear	19mm	330	415mm

Discovery			Bar Diameter	Rate lbs/in	Free Height
DA4277	Discovery 1	Front	16mm	225	390mm
DA4278	Discovery 1	Rear	18mm	285	385mm

Range Rover			Bar Diameter	Rate lbs/in	Free Height
DA4277	Range Rover Classic	Front	16mm	225	390mm
DA4278	Range Rover Classic	Rear	18mm	285	385mm

Air Spring Conversion Kits



Does the complexity of having air suspension on your Discovery 3 worry you?

DA5034

Discovery 3 coil conversion kit with module. This comprehensive kit contains everything you need to convert to conventional coil spring suspension. Kit comprises four strut units and module to prevent the air suspension lights from being illuminated.

Discovery 2

It is a sad fact that it's likely the air suspension on your Discovery 2 will fail - probably at the most inconvenient time possible. You then have a choice to make. Do you replace it with a new air spring system which is comfortable but not so comfortable on your wallet or replace with an equally comfortable but much more affordable and reliable coil spring system? Britpart have the complete kit for air to coil spring conversion making your decision that little bit easier.

DA5136	Standard ride height	Rear kit - black springs
DA5137	2" lift ride height	Rear kit - yellow springs
DA5007	2" lift ride height - heavy-duty	Front & rear kit - yellow springs
DA5008	2" lift ride height	Front & rear kit - yellow springs

Range Rover P38

The EAS (Electronic Air Suspension) System found on Range Rover 4.0 and 4.6 vehicles can present expensive, recurring maintenance problems. If you've had an air spring failure before, you know this first hand. Britpart now has a coil spring conversion kit for Range Rover 4.0 and 4.6 that makes switching to coil springs seamless and error-free. Conversion to coil springs provides a better, maintenance-free ride that will save you significant money over time. The EAS Override Module suppresses all typical false dashboard display errors and buzzers seen when converting to coil springs. Any mechanic or Range Rover owner can install this coil spring conversion kit without having to go to a Land Rover dealer or Autologic-equipped repair shop to eliminate false dash warning light errors.

The kit features:

- > Detailed step-by-step instructions.
- > The EAS Override Module overrides all typical computer errors seen when converting to coil springs.
- > Eliminates the need for a costly shop visit.
- > Aluminium spring perch adapters.
- > Britpart custom made coil springs provide standard ride height and maximum articulation.
- > Affordable alternative to expensive, recurring air suspension failures.
- > Trip computer compatibility - maintains operation of your vehicle's trip computer.
- > Kit provides everything needed to complete a professional installation.



DA4136

Range Rover P38 - 1995 - 2002 Petrol models and diesel light duty

DA4136HD

Range Rover P38 - 1995 - 2002 Heavy-duty 1" lift including diesel models

DA4136BUSH

Britpart yellow polyurethane bush kit for DA4136 & DA4136HD

BL4136BUSH

Britpart black polyurethane bush kit for DA4136 & DA4136HD

DA4136FR

Pair of replacement front coil springs for DA4136

DA4136RR

Pair of replacement rear coil springs for DA4136

DA4136HDFR

Pair of replacement front coil springs for DA4136HD

DA4136HRRR

Pair of replacement rear coil springs for DA4136HD

DA4136EAS

Range Rover P38 - 1995 - 2002

EAS Override module

EAS override module suppresses all typical false dashboard display errors and buzzers seen when converting to coil springs



Air to coil spring conversion kits from Britpart - get a reliable and maintenance-free ride for your Land Rover!



Photo courtesy of Alexander Kingsland



Photo courtesy of Darren Whaley

Suspension Kits

Britpart Super Gaz Suspension Kits

Shock Absorber & Spring Kits

DA4284	Defender 90/Discovery 1/Range Rover Classic	Heavy-duty	Standard height
DA4301	Defender 90/Discovery 1/Range Rover Classic	Light-duty	25mm lift
DA4286	Defender 90/Discovery 1/Range Rover Classic	Light-duty	40mm lift
DA4286MD	Defender 90/Discovery 1/Range Rover Classic	Medium-duty	40mm lift
DA4286HD	Defender 90/Discovery 1/Range Rover Classic	Heavy-duty	40mm lift
DA4285	Defender 110	Heavy-duty	Standard height
DA4287	Defender 110	Heavy-duty	40mm lift

Full Suspension Kits

DA4288	Defender 90 - up to 1994/Range Rover Classic - up to 1986	Narrow bush	Light-duty	40mm lift
DA4288MD	Defender 90 - up to 1994/Range Rover Classic - up to 1986	Narrow bush	Medium-duty	40mm lift
DA4288HD	Defender 90 - up to 1994/Range Rover Classic - up to 1986	Narrow bush	Heavy-duty	40mm lift
DA4289	Defender 90 - 1994 onwards/Discovery 1/Range Rover Classic - 1986 onwards	Wide bush	Light-duty	40mm lift
DA4289MD	Defender 90 - 1994 onwards/Discovery 1/Range Rover Classic - 1986 onwards	Wide bush	Medium-duty	40mm lift
DA4289HD	Defender 90 - 1994 onwards/Discovery 1/Range Rover Classic - 1986 onwards	Wide bush	Heavy-duty	40mm lift
DA4299	Defender 110 - up to 1994	Narrow bush	Heavy-duty	40mm lift
DA4300	Defender 110 - 1994 onwards	Wide bush	Heavy-duty	40mm lift



Britpart offers you a **complete or partial suspension package** suitable for whatever you intend to use your Land Rover for.



CELLULAR DYNAMIC - FULL SUSPENSION KIT



- Full suspension kits**
- > Springs - front & rear
 - > Shock absorbers - front & rear
 - > Radius arms - front & rear
 - > Spring retainers - front & rear
 - > Bush sets

SUPER GAZ - SHOCK ABSORBER & SPRING KIT



- Shock absorber & spring kits**
- > Springs - front & rear
 - > Shock absorbers - front & rear



Britpart Cellular Dynamic Suspension Kits

Shock Absorber & Spring Kits

DA4284C	Defender 90/Discovery 1/Range Rover Classic	Heavy-duty	Standard height
DA4301C	Defender 90/Discovery 1/Range Rover Classic	Light-duty	25mm lift
DA4286C	Defender 90/Discovery 1/Range Rover Classic	Light-duty	40mm lift
DA4286CMD	Defender 90/Discovery 1/Range Rover Classic	Medium-duty	40mm lift
DA4286CHD	Defender 90/Discovery 1/Range Rover Classic	Heavy-duty	40mm lift
DA4363	Defender 90/Discovery 1/Range Rover Classic	Light-duty	Plus 5" shock*
DA4285C	Defender 110	Heavy-duty	Standard height
DA4287C	Defender 110	Heavy-duty	40mm lift
DA4364	Defender 110	Heavy-duty	Plus 5" shock*

Full Suspension Kits

DA4288C	Defender 90 - up to 1994/Range Rover Classic - up to 1986	Narrow bush	Light-duty	40mm lift
DA4288CMD	Defender 90 - up to 1994/Range Rover Classic - up to 1986	Narrow bush	Medium-duty	40mm lift
DA4288CHD	Defender 90 - up to 1994/Range Rover Classic - up to 1986	Narrow bush	Heavy-duty	40mm lift
DA4365	Defender 90 - up to 1994/Range Rover Classic - up to 1986	Narrow bush	Medium-duty	Plus 5" shock*
DA4289C	Defender 90 - 1994 onwards/Discovery 1/Range Rover Classic - 1986 onwards	Wide bush	Light-duty	40mm lift
DA4289CMD	Defender 90 - 1994 onwards/Discovery 1/Range Rover Classic - 1986 onwards	Wide bush	Medium-duty	40mm lift
DA4289CHD	Defender 90 - 1994 onwards/Discovery 1/Range Rover Classic - 1986 onwards	Wide bush	Heavy-duty	40mm lift
DA4366	Defender 90 - 1994 onwards/Discovery 1/Range Rover Classic - 1986 onwards	Wide bush	Medium-duty	Plus 5" shock*
DA4299C	Defender 110 - up to 1994	Narrow bush	Heavy-duty	40mm lift
DA4367	Defender 110 - up to 1994	Narrow bush	Heavy-duty	Plus 5" shock*
DA4300C	Defender 110 - 1994 onwards	Wide bush	Heavy-duty	40mm lift
DA4368	Defender 110 - 1994 onwards	Wide bush	Heavy-duty	Plus 5" shock*
DA1234	Defender 90/Discovery 1/Range Rover Classic - with axle brackets			1" lower

*Note - The Plus 5" Cellular Dynamic Shock Absorbers are specialist suspension products and to install them additional fabrication work or brackets may be required. Please ensure that they are fitted by a competent expert. Open and closed dimensions - DC6000LL - 765-455mm & DC60001LL - 750-440mm.

Propshafts

Propshaft Kit

DA6355

Defender/Discovery 1/Range Rover Classic

- > 300Tdi & Td5 models only
- > Double cardan extreme use front propshaft with flange and fitting kit.
- > For vehicles with L230 transfer boxes.
- > Ideal for use with lifted vehicles.
- > Helps to reduce driveline vibration where diff and transfer flanges are not in-line.

Note - Flange must be fitted to transfer box.



Propshaft Spacer Kit

DA6339

Defender/Discovery 1/Range Rover Classic

15mm propshaft spacer kit machined from billet aluminium and anodised deep blue. When suspension lift kit is fitted it increases the distance between the transfer box flange and the diff flange. This increased distance can cause the propshaft to run out of spline travel. Fitting this 15mm prop spacer helps return the propshaft to its normal operating length therefore allowing full spline travel which also helps reduce the characteristic "binding" of the yokes when a propshaft is over extended.



Wide Angle Propshafts

If your Land Rover has raised suspension or been modified for extreme axle articulation then the joints on the existing propshaft will become strained. This will cause the propshaft to lock up or vibrate and wear the universal joints prematurely. Dropping the axle further away from the chassis is great for looks, articulation and off-road performance - a neat solution is to fit a wide angle propshaft. This allows drivetrain angles of up to 32 degrees which reduces vibration, universal joint 'bind-up' and premature wear on the joints. These wide angle shafts have greasable universal joints which are more desirable where longer life is required.

DA6350	Front	Defender - from MA - 300Tdi & Td5/Discovery 1/Range Rover Classic - 1986 - 1991	FRC8386
DA6352	Front	Defender - up to LA (1993)	FRC8390/FRC5566
DA6351	Rear	Defender 90 - 4 cylinder	FRC8392
DA6353	Rear	Defender 90 - V8 - up to 2007 & diesel from MA	FRC8393
DA6354	Rear	Discovery 1 - 1989 - 1994 & V8 from 1997	FRC8387
DA6356		Replacement heavy-duty universal joint for wide angle propshafts	
DA1123		Nut & bolt kit - each kit contains 4 nuts - for transfer box end & 4 nuts & bolts - for diff end. Enough nuts & bolts to make propshaft repair out in the field. Suitable for DA6350; DA6351; DA6352, DA6353 & DA6354.	



Steering

Steering Dampers

Britpart Cellular Dynamic

DC6004	Defender
DC6005	Discovery 1/Range Rover Classic/Series
DC6009	Discovery 2
DC6006	Range Rover P38

Britpart Super Gaz

DC5004	Defender
DC5005	Discovery 1/Range Rover Classic/Series



Old Man Emu

DA8925 NEW	Defender 90, 110 & 130
DA3066 NEW	Discovery 1
DA3135 NEW	Discovery 2
DA3066 NEW	Range Rover Classic

Features

- > 9 stage valving for optimum performance.
- > Massive 35mm bore.
- > Stone guard.
- > Fits original mounts.
- > 50/50 valving.



Heavy-Duty Steering Arms

- > All OEM track rod ends
- > Solid heavy-duty arms which are suitable for off-road use
- > Improves steering response
- > Zinc plate finish to increase corrosion resistance

DA5501	Series	4 track rod ends
DA5502	Defender 90/110	3 track rod ends
DA5503	Discovery 1/Range Rover Classic	3 track rod ends
DA5504	Discovery 1	4 track rod ends
DA5509	Discovery 2	4 track rod ends
DA5541 NEW	Fixing kit for DA5503 & DA5504	

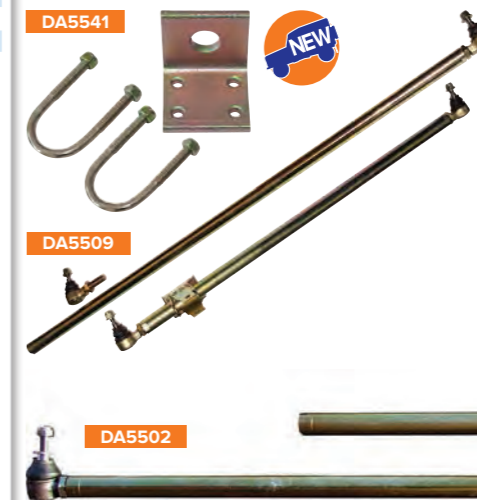

Improves steering response

Shock Absorber & Suspension Kit Matrix

	Defender 90	Defender 110	Discovery 1	Discovery 2	Range Rover Classic	Range Rover P38	Series
Super Gaz Shock Absorbers							
Front							
Standard	DC5002	DC5002	DC5002	DC5000	DC5002		
50mm lift	DC5002L	DC5002L	DC5002L	DC5000L	DC5002L		
Rear							
Standard	DC5003	DC5003	DC5003	DC5001	DC5003		
50mm lift	DC5003L	DC5003L	DC5003L	DC5001L	DC5003L		
Steering damper							
Standard	DC5004	DC5004	DC5005		DC5005		DC5005
50mm lift	DC5004	DC5004	DC5005		DC5005		DC5005
Super Gaz Shock Absorber Suspension Kits							
Shock Absorber & Spring Kits							
Standard - heavy-duty kit	DA4284	DA4285	DA4284		DA4284		
25mm lift - light-duty kit	DA4301		DA4301		DA4301		
40mm lift - light-duty kit	DA4286		DA4286		DA4286		
40mm lift - medium-duty kit	DA4286MD		DA4286MD		DA4286MD		
40mm lift - heavy-duty kit	DA4286HD	DA4287	DA4286HD		DA4286HD		
40mm lift - no winch - kit				DA5008			
40mm lift - with winch - kit				DA5007			
Full Suspension Kits							
40mm lift - narrow bush - light-duty kit	DA4288				DA4288		
40mm lift - narrow bush - medium-duty kit	DA4288MD				DA4288MD		
40mm lift - narrow bush - heavy-duty kit	DA4288HD	DA4299			DA4288HD		
40mm lift - wide bush - light-duty kit	DA4289		DA4289		DA4289		
40mm lift - wide bush - medium-duty kit	DA4289MD		DA4289MD		DA4289MD		
40mm lift - wide bush - heavy-duty kit	DA4289HD	DA4300	DA4289HD		DA4289HD		
Cellular Dynamic Shock Absorbers							
Front							
Standard	DC6000	DC6000	DC6000	DC6010	DC6000	DC6002	
50mm lift	DC6000L	DC6000L	DC6000L		DC6000L		
Plus 5" shock absorber	DC6000LL	DC6000LL	DC6000LL		DC6000LL		
Rear							
Standard	DC6001	DC6001	DC6001	DC6011	DC6001	DC6003	
50mm lift	DC6001L	DC6001L	DC6001L		DC6001L		
Plus 5" shock absorber	DC6001LL	DC6001LL	DC6001LL		DC6001LL		
Steering damper							
Standard	DC6004	DC6004	DC6005	DC6009	DC6005	DC6006	DC6005
50mm lift	DC6004	DC6004	DC6005		DC6005		
Plus 5" shock absorber	DC6004	DC6004	DC6005		DC6005		
Cellular Dynamic Shock Absorber Suspension Kits							
Shock Absorber & Spring Kits							
Standard height - heavy-duty kit	DA4284C	DA4285C	DA4284C		DA4284C		
25mm lift - light-duty kit	DA4301C		DA4301C		DA4301C		
40mm lift - light-duty kit	DA4286C		DA4286C		DA4286C		
40mm lift - medium-duty kit	DA4286CMD		DA4286CMD		DA4286CMD		
40mm lift - heavy-duty kit	DA4286CHD	DA4287C	DA4286CHD		DA4286CHD		
Plus 5" shock absorber - light-duty kit	DA4363		DA4363		DA4363		
Plus 5" shock absorber - heavy-duty kit		DA4364					
Full Suspension Kits							
40mm lift - narrow bush - light-duty kit	DA4288C				DA4288C		
40mm lift - narrow bush - medium-duty kit	DA4288CMD				DA4288CMD		
40mm lift - narrow bush - heavy-duty kit	DA4288CHD	DA4299C			DA4288CHD		
Plus 5" shock - narrow bush - medium-duty kit	DA4365				DA4365		
Plus 5" shock - narrow bush - heavy-duty kit		DA4367					
40mm lift - wide bush - light-duty kit	DA4289C		DA4289C		DA4289C		
40mm lift - wide bush - medium-duty kit	DA4289CMD		DA4289CMD		DA4289CMD		
40mm lift - wide bush - heavy-duty kit	DA4289CHD	DA4300C	DA4289CHD		DA4289CHD		
Plus 5" shock absorber - wide bush - medium-duty kit	DA4366		DA4366		DA4366		
Plus 5" shock absorber - wide bush - heavy-duty kit		DA4368					

Vehicle Diagnostics

Finding and rectifying common electrical faults in your Land Rover has never been easier with the Lynx diagnostics tool from Britpart.

Lynx Diagnostics Interface 138 - 146

Calibration Tools 142



Lynx Diagnostics Interface

What is Lynx?

Finding and rectifying common Land Rover electrical faults has never been easier. Britpart have worked closely with Omitec to design and build a highly advanced Land Rover diagnostic tool. As well as the multi-model professional version, a single Land Rover model home use version is available too.

The Lynx interface is Windows® based and when running diagnostics on a Windows laptop or Windows tablet, far more information can be displayed to the user than on a hand held device. Being Windows based there is familiarity and flexibility with the interface and navigation is much more intuitive.

Your complete Land Rover diagnostics tool!

What does Lynx do?

- > Read fault codes
- > Clear fault codes
- > Read live data
- > Record & play back live data
- > Test actuators
- > Special functions - see coverage chart
- > Programming - such as alarm settings, key fobs etc.
- > Service reset

What do you get with Lynx?

- > Windows compatible software
- > Vehicle Communication Interface box (VCI)
- > USB to VCI lead
- > VCI to OBD II lead
- > Quick start booklet
- > Activation form
- > Unlock code booklet
- > Carry case with foam insert



More about Lynx

As Lynx is Windows based, the system is future proofed due to your laptop or tablet's hard disk drive which allows for 'many more' numbers of updates compared to hand held devices. Lynx is powered by Omitec who build the T4 – Official Land Rover diagnostics tool. Live data can also be displayed using graphics; making it easier to read time based events. Live data can be recorded for a comparison, a great advantage over hand held diagnostic tools as they do not usually have storage memory. The Windows based tool allows simultaneous access to the vehicle diagnostics and consultation of circuit diagrams and other technical information. Lynx will also allow you to access the internet if you are connected to it whilst diagnosing a vehicle and other such programs you might need to use in a garage environment. Lynx is supplied in a hard wearing carry case with foam insert to protect it when not in use. For the enthusiast home user, using Lynx will mean no more trips to your local main dealer to clear any faults on your Land Rover.

For the workshop and home user...

What do I need?

Multi-model professional version

Unlocked for all Land Rover models in Lynx range. See overleaf for full Lynx model coverage.

DA6431	English
DA6431ESP	Spanish
DA6431GER	German
DA6431FRA	French

Single model home user version

Unlocked for one Land Rover model only. Upgradable for extra Land Rover models at a later date.

DA6430	English
DA6430ESP	Spanish
DA6430GER	German
DA6430FRA	French

DA6434 Home user additional Land Rover model unlock code

Extras

DA6432	14CUX lead - for use with hot wire V8 Efi vehicles
DA6433	Upgrade lead - power cable for use with firmware updates
DA6433EU	Upgrade lead - European 2-pin power cable for use with firmware updates

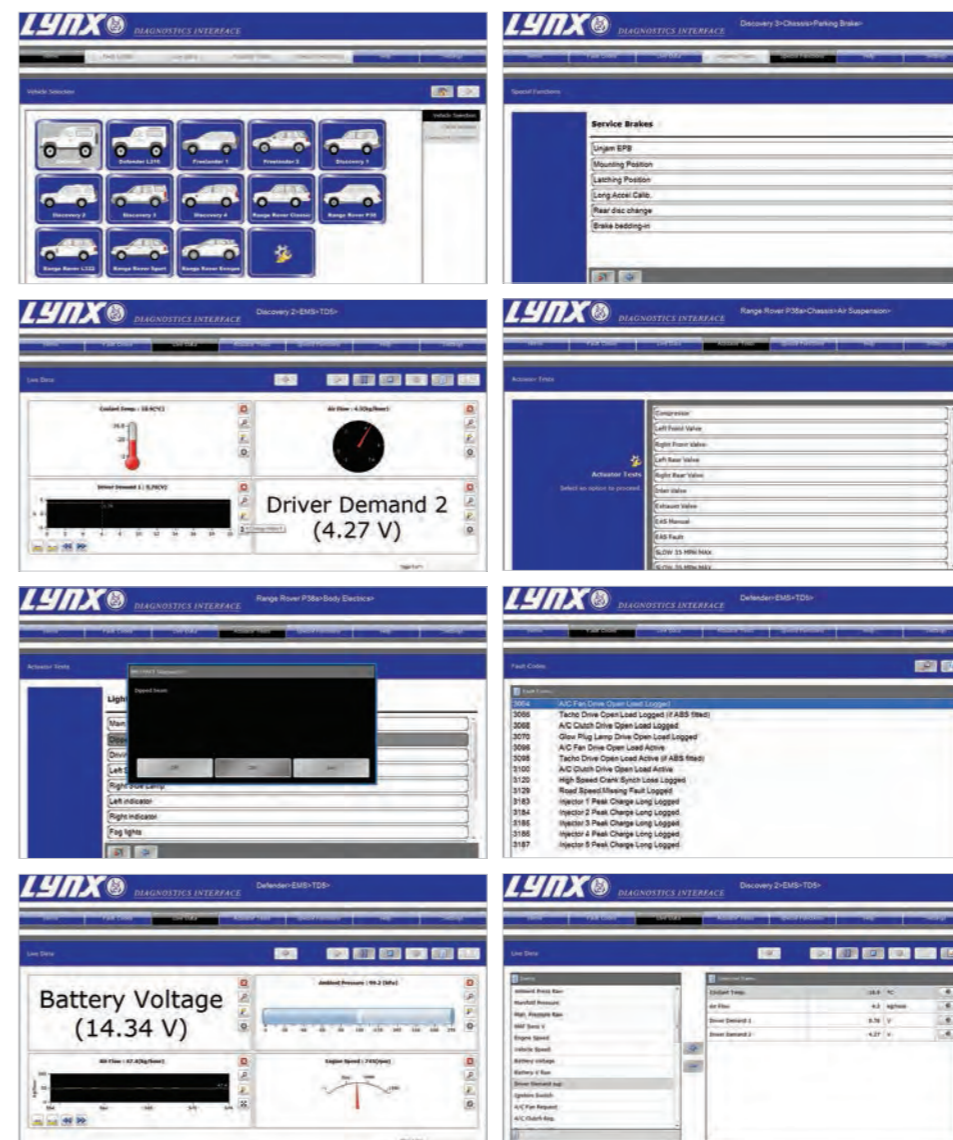

See Fuzz Townshend, from Car SOS, using the Lynx at home and in a workshop at www.lynx-diagnostics.com

Now compatible with Windows 10

Software updates available online

View live data with intuitive interface



www.lynx-diagnostics.com

System Requirements

*Microsoft Windows based PC or tablet with - Microsoft Windows XP, Windows Vista, Windows 7 & Windows 8.1 & Windows 10 operating system. USB socket. 500MB available hard disk space (minimum). 1024 x 768 screen resolution (minimum). Administrative rights - only required for software installation.

Lynx Vehicle Coverage - continued

Vehicle Model	Years	System	System Name	Key to Lynx Version 2.6.2							
				Rear Fault Codes	Clear Fault Codes	Live Data	ECM Data	Actuators	Programming	Maintenance	
Discovery 4	2010 - 2011	Infotainment - Audio and Visual	DABM - Digital Audio Broadcast Module	●	●	●	●				
Discovery 4	2010 - 2011	Infotainment - Audio and Visual	DACMC - Digital Audio Control Module 'C'	●	●	●	●				
Discovery 4	2010 - 2011	Infotainment - Audio and Visual	SRM - Satellite Audio Unit Module	●	●	●	●				
Discovery 4	2010 - 2011	Infotainment - Audio and Visual	TVM - Television Module	●	●	●	●				
Discovery 4	2010 - 2011	Infotainment - APIM	APIM - Accessory Protocol Interface Module	●	●	●	●				
Discovery 4	2010 - 2011	Infotainment - REM	REM - Rear Entertainment Control Module	●	●	●	●				
Discovery 4	2010 - 2011	Infotainment - TEL	TEL - Cellular Telephone Control Module	●	●	●	●				
Discovery 4	2010 - 2011	Infotainment - SPRM	SPRM - Speech Recognition Control Module	●	●	●	●				
Discovery 4	2010 - 2011	Infotainment - IPMB	IPMB - Image Processing Module 'B'	●	●	●	●				
Discovery 4	2010 - 2011	Service Functions - Service Reset	IPC - Instrument Panel Control Module								●
Discovery 4	2010 - 2011	Global Function - Clear DTCs	High Speed CAN Clear DTCs		●						
Discovery 4	2010 - 2011	Global Function - Clear DTCs	Medium Speed CAN Clear DTCs		●						
Discovery 4	2010 - 2011	Global Functions - ECU Reset	High Speed CAN ECU Reset								●
Discovery 4	2010 - 2011	Global Functions - ECU Reset	Medium Speed CAN ECU Reset								●
Discovery 4	2012 -	Drive - Diesel EMS	PCM - Power Train Control Module (Diesel V6 2.7)	●	●	●	●				●
Discovery 4	2012 -	Drive - Diesel EMS	PCM - Power Train Control Module (Diesel V6 3.0)	●	●	●	●				●
Discovery 4	2012 -	Drive - Petrol EMS	PCM - Power Train Control Module (Petrol)	●	●	●	●				●
Discovery 4	2012 -	Drive - Transmission	TCM - Transmission Control Module (Diesel V6 2.7)	●	●	●	●				●
Discovery 4	2012 -	Drive - Transmission	TCM - Transmission Control Module (Diesel V6 3.0)	●	●	●	●				●
Discovery 4	2012 -	Drive - Transmission	TCM - Transmission Control Module (Petrol)	●	●	●	●				●
Discovery 4	2012 -	Drive - Transmission	GSM - Gear Shift Module	●	●	●	●				●
Discovery 4	2012 -	Drive - Transmission	RDCM - Rear Differential Control Module	●	●	●	●				●
Discovery 4	2012 -	Drive - Transfer Case	TCCM - Transfer Case Control Module	●	●	●	●				●
Discovery 4	2012 -	Chassis - ABS / DSC	ABS / DSC - Antilocking brake System / Dynamic Stability Control	●	●	●	●				●
Discovery 4	2012 -	Chassis - Steering Angle	SASM - Steering Angle Sensor Module	●	●	●	●				●
Discovery 4	2012 -	Chassis - Park Brake	PBM - Park Brake Module	●	●	●	●				●
Discovery 4	2012 -	Chassis - ATCM	ATCM - All Terrain Control Module	●	●	●	●				●
Discovery 4	2012 -	Chassis - Suspension	RLM - Ride Level Control Module	●	●	●	●				●
Discovery 4	2012 -	Body - Airbag	RCM - Restraints Control Module	●	●	●	●				●
Discovery 4	2012 -	Body - Airbag	OCS - Occupancy Classification System	●	●	●	●				●
Discovery 4	2012 -	Body - Climate Control	HVAC - Heating Ventilation Air Conditioning Control Module	●	●	●	●				●
Discovery 4	2012 -	Body - Body Controller	BCM - Body Control Module	●	●	●	●				●
Discovery 4	2012 -	Body - Instruments	IPC - Instrument Panel Control Module	●	●	●	●				●
Discovery 4	2012 -	Body - Lighting Control	HCM - Headlamp Control Module	●	●	●	●				●
Discovery 4	2012 -	Body - Lighting Control	HCMB - Headlamp Control Module 'B'	●	●	●	●				●
Discovery 4	2012 -	Body - Parking Aid	PAM - Parking Aid Module	●	●	●	●				●
Discovery 4	2012 -	Body - Immobiliser	Immobiliser	●	●	●	●				●
Discovery 4	2012 -	Body - Fuel Fired Heater	FFH - Fuel Fired Heater	●	●	●	●				●
Discovery 4	2012 -	Body - Doors	DDM - Drivers Door Module	●	●	●	●				●
Discovery 4	2012 -	Body - Doors	PDM - Passengers Door Module	●	●	●	●				●
Discovery 4	2012 -	Body - KVM	KVM - Keyless Vehicle Module	●	●	●	●				●
Discovery 4	2012 -	Infotainment - Audio and Visual	FCDIM - Front Control / Display Interface Module	●	●	●	●				●
Discovery 4	2012 -	Infotainment - Audio and Visual	FCIM - Front Control Interface Module	●	●	●	●				●
Discovery 4	2012 -	Infotainment - Audio and Visual	FCIMB - Front Control Interface Module 'B'	●	●	●	●				●
Discovery 4	2012 -	Infotainment - IPMB	IPMB - Image Processing Module 'B'	●	●	●	●				●
Discovery 4	2012 -	Service Functions - Service Reset	IPC - Instrument Panel Control Module								●
Discovery 4	2012 -	Global Function - Clear DTCs	High Speed CAN Clear DTCs		●						
Discovery 4	2012 -	Global Function - Clear DTCs	Medium Speed CAN Clear DTCs		●						
Discovery 4	2012 -	Global Functions - ECU Reset	High Speed CAN ECU Reset								●
Discovery 4	2012 -	Global Functions - ECU Reset	Medium Speed CAN ECU Reset								●
Range Rover Classic	1990 - 1995	Petrol EMS	14CUX	●	●	●	●				
Range Rover P38	1995 - 2002	Diesel EMS	Bosch EDC 1.31	●	●	●	●				●
Range Rover P38	1999 - 2002	Petrol EMS	Bosch M5.21	●	●	●	●				●
Range Rover P38	1995 - 1999	Petrol EMS	GEMS	●	●	●	●				●
Range Rover P38	1998 - 2002	Transmission	GS 2.38	●	●	●	●				●
Range Rover P38	1998 - 2002	Transmission	GS 8.87X	●	●	●	●				●
Range Rover P38	1995 - 1999	ABS	WABCO C ABS	●	●	●	●				●
Range Rover P38	1999 - 2002	ABS	WABCO D ABS	●	●	●	●				●
Range Rover P38	1995 - 1999	Airbag	TRW MPS	●	●	●	●				●
Range Rover P38	1995 - 2002	Airbag	TRW SPS	●	●	●	●				●
Range Rover P38	1998 - 2002	Airbag	TRW Gen 4	●	●	●	●				●
Range Rover P38	1998 - 2002	Climate Control	HVAC - Heating Ventilation Air Conditioning Control Module	●	●	●	●				●
Range Rover P38	1995 - 2002	Chassis	Air Suspension	●	●	●	●				●
Range Rover P38	1995 - 2002	Body Electrics	BeCM	●	●	●	●				●

Calibration Tools

To help with air suspension calibration we also offer these calibration blocks which can be used in conjunction with our Lynx diagnostics kit.

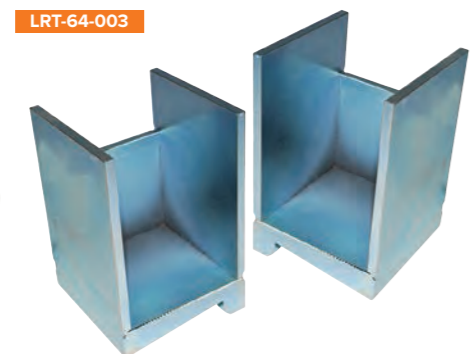

LRT-60-003 Range Rover P38
LRT-64-003 Discovery 2

Lynx Vehicle Coverage - continued

Vehicle Model	Years	System	System Name	Key to Lynx Version 2.6.2							
				Rear Fault Codes	Clear Fault Codes	Live Data	ECM Data	Actuators	Programming	Maintenance	
Range Rover L322	2002 - 2005	Drive - Diesel EMS	Bosch DDE4	●	●	●	●				
Range Rover L322	2002 - 2005	Drive - Petrol EMS	Bosch ME72	●	●	●	●				
Range Rover L322	2002 - 2005	Drive - Transmission	GM5 / EGS 20	●	●	●	●				
Range Rover L322	2002 - 2005	Drive - Transmission	ZF / EGS 8602	●	●	●	●				
Range Rover L322	2002 - 2005	Chassis - ABS / DSC	Bosch 5.7	●	●	●	●				
Range Rover L322	2002 - 2005	Chassis - Steering Angle	Steering Angle	●	●	●	●				●
Range Rover L322	2002 - 2005	Chassis - Air Suspension	EHC2	●	●	●	●				●
Range Rover L322	2002 - 2005	Body - Airbag	MRS 4	●	●	●	●				
Range Rover L322	2002 - 2005	Body - Climate Control	HVAC - Heating Ventilation Air Conditioning Control Module	●	●	●	●				
Range Rover L322	2002 - 2005	Body - Body Electrics	GM3	●	●	●	●				
Range Rover L322	2002 - 2005	Body - Security	EWS3	●	●	●	●				
Range Rover L322	2002 - 2005	Body - Fuel Fired Heater	Fuel Fired Heater	●	●	●	●				●
Range Rover L322	2002 - 2005	Infotainment - Audio and Video	AAM - Audio Amplifier Module	●	●	●	●				
Range Rover L322	2002 - 2005	Infotainment - Audio and Video	ACM - Audio Control Module	●	●	●	●				
Range Rover L322	2002 - 2005	Infotainment - Audio and Video	FEM - Front Electronic Module	●	●	●	●				
Range Rover L322	2002 - 2005	Infotainment - Audio and Video	CDP - Compact Disc Player	●	●	●	●				
Range Rover L322	2002 - 2005	Infotainment - Audio and Video	SRM - Satellite Audio Unit Module	●	●	●	●				
Range Rover L322	2002 - 2005	Infotainment - Audio and Video	TVM - Television Module	●	●	●	●				
Range Rover L322	2002 - 2005	Infotainment - REM	REM - Rear Entertainment Control Module	●	●	●	●				
Range Rover L322	2002 - 2005	Infotainment - TEL	TEL - Cellular Telephone Control Module	●	●	●	●				
Range Rover L322	2002 - 2005	Infotainment - TMC	TMC - Traffic Message Channel Module	●	●	●	●				
Range Rover L322	2002 - 2005	Service Function - Service Reset	Service Reset								●
Range Rover L322	2006	Drive - Diesel EMS	Bosch DDE4	●	●	●	●				
Range Rover L322	2006	Drive - Petrol EMS	Denso PAN PAG	●	●	●	●				●
Range Rover L322	2006	Drive - Transmission (Diesel)	GM5 / EGS 20	●	●	●	●				●
Range Rover L322	2006	Drive - Transmission (Petrol)	TCM - Transmission Control Module	●	●	●	●				●
Range Rover L322	2006	Drive - Transmission	TCCM - Transfer Case Control Module	●	●	●	●				●
Range Rover L322	2006	Chassis - ABS (Diesel)	Bosch 5.7	●	●	●	●				
Range Rover L322	2006	Chassis - ABS (Petrol)	Bosch 8	●	●	●	●				
Range Rover L322	2006	Chassis - Steering Angle (Diesel)	SASM - Steering Angle Sensor Module	●	●	●	●				●
Range Rover L322	2006	Chassis - Steering Angle (Petrol)	SASM - Steering Angle Sensor Module	●	●	●	●				●
Range Rover L322	2006	Chassis - TPMS	TPMS - Tyre Pressure Monitoring System	●	●	●	●				●
Range Rover L322	2006	Chassis - Air Suspension	RLM - Ride Level Control Module	●	●	●	●				●
Range Rover L322	2006	Body - Airbag	MRS 4	●	●	●	●				
Range Rover L322	2006	Body - Climate Control	HVAC - Heating Ventilation Air Conditioning Control Module	●	●	●	●				
Range Rover L322	2006	Body - Body Electrics	GM3	●	●	●	●				
Range Rover L322	2006	Body - Instruments	IPC - Instrument Panel Control Module	●	●	●	●				●
Range Rover L322	2006	Body - Lighting Control	FLM - Front Lighting Module	●	●	●	●				
Range Rover L322	2006	Body - Security	Body Controller	●	●	●	●				
Range Rover L322	2006	Body - Fuel Fired Heater	Fuel Fired Heater	●	●	●	●				●
Range Rover L322	2006	Body - RDUM	RDUM - Remote Driver Utility Module	●	●	●	●				
Range Rover L322	2006	Infotainment - Audio and Video	AAM - Audio Amplifier Module	●	●	●	●				
Range Rover L322	2006	Infotainment - Audio and Video	ACM - Audio Control Module	●	●	●	●				
Range Rover L322	2006	Infotainment - Audio and Video	FEM - Front Electronic Module	●	●	●	●				
Range Rover L322	2006	Infotainment - Audio and Video	CDP - Compact Disc Player	●	●	●	●				
Range Rover L322	2006	Infotainment - Audio and Video	SRM - Satellite Audio Unit Module	●	●	●	●				
Range Rover L322	2006	Infotainment - Audio and Video	TVM - Television Module	●	●	●	●				
Range Rover L322	2006	Infotainment - REM	REM - Rear Entertainment Control Module	●	●	●	●				
Range Rover L322	2006	Infotainment - TEL	TEL -								

Lynx Vehicle Coverage - continued

Key to Lynx Version 2.6.2

- Existing feature
- Enhanced feature
- ◆ New feature

Vehicle Model	Years	System	System Name	Rear Fault Codes	Clear Fault Codes	Live Data	ECM Data	Actuators	Programming	Maintenance
Range Rover L322	2010 - 2012	Diesel - V8 3.6 - Engine	PCM - Power Train Control Module (Diesel)	●	●	●	●			●
Range Rover L322	2010 - 2012	Diesel - V8 3.6 - Transmission	TCM - Transmission Control Module	●	●	●	●			
Range Rover L322	2010 - 2012	Diesel - V8 3.6 - Transmission	RDCM - Rear Differential Control Module	●	●	●	●			
Range Rover L322	2010 - 2012	Diesel - V8 3.6 - Transfer Case	TCCM - Transfer Case Control Module	●	●	●	●			
Range Rover L322	2010 - 2012	Diesel - V8 3.6 - Adaptive Cruise Control	CCM - Cruise Control Module	●	●	●	●			
Range Rover L322	2010 - 2012	Diesel - V8 4.4 - Engine	PCM - Power Train Control Module (Diesel)	●	●	●	●			●
Range Rover L322	2010 - 2012	Diesel - V8 4.4 - Transmission	TCM - Transmission Control Module	●	●	●	●			
Range Rover L322	2010 - 2012	Diesel - V8 4.4 - Transmission	GSM - Gear Shift Module	●	●	●	●			
Range Rover L322	2010 - 2012	Diesel - V8 4.4 - Transmission	RDCM - Rear Differential Control Module	●	●	●	●			
Range Rover L322	2010 - 2012	Diesel - V8 4.4 - Transfer Case	TCCM - Transfer Case Control Module	●	●	●	●			
Range Rover L322	2010 - 2012	Diesel - V8 4.4 - Adaptive Cruise Control	CCM - Cruise Control Module	●	●	●	●			
Range Rover L322	2010 - 2012	Petrol - Engine	PCM - Power Train Control Module (Petrol)	●	●	●	●			
Range Rover L322	2010 - 2012	Petrol - Transmission	TCM - Transmission Control Module	●	●	●	●			
Range Rover L322	2010 - 2012	Petrol - Transmission	RDCM - Rear Differential Control Module	●	●	●	●			
Range Rover L322	2010 - 2012	Petrol - Transfer Case	TCCM - Transfer Case Control Module	●	●	●	●			
Range Rover L322	2010 - 2012	Petrol - Adaptive Cruise Control	CCM - Cruise Control Module	●	●	●	●			
Range Rover L322	2010 - 2012	Chassis - ABS / DSC	ABS / DSC - Antilocking brake System / Dynamic Stability Control	●	●	●	●			
Range Rover L322	2010 - 2012	Chassis - Steering Angle	SASM - Steering Angle Sensor Module	●	●	●	●			
Range Rover L322	2010 - 2012	Chassis - Parking Brake	PBM - Park Brake Module	●	●	●	●			●
Range Rover L322	2010 - 2012	Chassis - Suspension	RLM - Ride Level Control Module	●	●	●	●			●
Range Rover L322	2010 - 2012	Chassis - Suspension	ADCM - Adaptive Damping Control Module	●	●	●	●			
Range Rover L322	2010 - 2012	Chassis - Chassis	ATCM - All Terrain Control Module	●	●	●	●			
Range Rover L322	2010 - 2012	Body - Airbag	RCM - Restraints Control Module	●	●	◆	●			
Range Rover L322	2010 - 2012	Body - Airbag	OCS - Occupancy Classification System	●	●	◆	●			
Range Rover L322	2010 - 2012	Body - Climate Control	HVAC - Heating Ventilation Air Conditioning Control Module	●	●	●	●			
Range Rover L322	2010 - 2012	Body - Climate Control	RHVAC - Rear Heating Ventilation Air Conditioning Control Module	●	●	●	●			
Range Rover L322	2010 - 2012	Body - Body Controller	BCM - Body Control Module	●	●	●	●			●
Range Rover L322	2010 - 2012	Body - Instruments	IPC - Instrument Panel Control Module	●	●	●	●			●
Range Rover L322	2010 - 2012	Body - Lighting Control	HCM - Headlamp Control Module	●	●	●	●			
Range Rover L322	2010 - 2012	Body - Lighting Control	HCMB - Headlamp Control Module 'B'	●	●	●	●			
Range Rover L322	2010 - 2012	Body - Parking Aid	PAM - Parking Aid Module	●	●	◆	●			
Range Rover L322	2010 - 2012	Body - Object Detection	SODL - Side Object Detection Module Left	●	●	●	●			
Range Rover L322	2010 - 2012	Body - Object Detection	SODR - Side Object Detection Module Right	●	●	●	●			
Range Rover L322	2010 - 2012	Body - Immobiliser	Immobiliser	●	●	●	●			
Range Rover L322	2010 - 2012	Body - Fuel-Fired Heater	FFH - Fuel Fired Heater	●	●	●	●			
Range Rover L322	2010 - 2012	Body - Seating	DSM - Drivers Seat Module	●	●	●	●			
Range Rover L322	2010 - 2012	Body - Seating	PSM - Passengers Seat Module	●	●	●	●			
Range Rover L322	2010 - 2012	Body - Seating	DCSM - Drivers Climate Seat Module	●	●	●	●			
Range Rover L322	2010 - 2012	Body - Seating	RDCSM - Rear Climate Seat Module	●	●	●	●			
Range Rover L322	2010 - 2012	Body - Doors	DDM - Drivers Door Module	●	●	●	●			
Range Rover L322	2010 - 2012	Body - Doors	PDM - Passengers Door Module	●	●	●	●			
Range Rover L322	2010 - 2012	Body - KVM	KVM - Keyless Vehicle Module	●	●	●	●			
Range Rover L322	2010 - 2012	Body - RBM	RBM - Running Board Control Module	●	●	●	●			
Range Rover L322	2010 - 2012	Body - RDUM	RDUM - Remote Driver Utility Module	●	●	●	●			
Range Rover L322	2010 - 2012	Infotainment - Audio and Video	AAM - Audio Amplifier Module	●	●	●	●			
Range Rover L322	2010 - 2012	Infotainment - Audio and Video	ACM - Audio Control Module	●	●	●	●			
Range Rover L322	2010 - 2012	Infotainment - Audio and Video	FEM - Front Electronic Module	●	●	●	●			
Range Rover L322	2010 - 2012	Infotainment - Audio and Video	CDP - Compact Disc Player	●	●	●	●			
Range Rover L322	2010 - 2012	Infotainment - Audio and Video	DABM - Digital Audio Broadcast Module	●	●	●	●			
Range Rover L322	2010 - 2012	Infotainment - Audio and Video	DACMC - Digital Audio Control Module 'C'	●	●	●	●			
Range Rover L322	2010 - 2012	Infotainment - Audio and Video	SRM - Satellite Audio Unit Module	●	●	●	●			
Range Rover L322	2010 - 2012	Infotainment - Audio and Video	TVM - Television Module	●	●	●	●			
Range Rover L322	2010 - 2012	Infotainment - APIM	APIM - Accessory Protocol Interface Module	●	●	●	●			
Range Rover L322	2010 - 2012	Infotainment - REM	REM - Rear Entertainment Control Module	●	●	●	●			
Range Rover L322	2010 - 2012	Infotainment - TEL	TEL - Cellular Telephone Control Module	●	●	●	●			
Range Rover L322	2010 - 2012	Infotainment - IPMB	IPMB - Image Processing Module 'B'	●	●	●	●			
Range Rover L322	2010 - 2012	Service Functions - Service Reset	IPC - Instrument Panel Control Module		●					●
Range Rover L322	2010 - 2012	Global Function - Clear DTCs	High Speed CAN Clear DTCs		●					
Range Rover L322	2010 - 2012	Global Function - Clear DTCs	Medium Speed CAN Clear DTCs		●					
Range Rover L322	2010 - 2012	Global Functions - ECU Reset	High Speed CAN ECU Reset							●
Range Rover L322	2010 - 2012	Global Functions - ECU Reset	Medium Speed CAN ECU Reset							●

Range Rover Sport	2005 - 2009	Drive - Diesel EMS	PCM - Power Train Control Module (Diesel)	●	●	●	●	◆		●
Range Rover Sport	2005 - 2009	Drive - Petrol EMS	PCM - Power Train Control Module (Petrol)	●	●	●	●			
Range Rover Sport	2005 - 2009	Drive - Transmission	TCM - Transmission Control Module	●	●	●	●			◆
Range Rover Sport	2005 - 2009	Drive - Transmission	RDCM - Rear Differential Control Module	●	●	●	●			
Range Rover Sport	2005 - 2009	Drive - Transfer Case	TCCM - Transfer Case Control Module	●	●	●	●			
Range Rover Sport	2005 - 2009	Drive - Adaptive Cruise Control	CCM - Cruise Control Module	●	●	●	●			
Range Rover Sport	2005 - 2009	Chassis - ABS / DSC	ABS / DSC - Antilocking brake System / Dynamic Stability Control	●	●	●	●			◆
Range Rover Sport	2005 - 2009	Chassis - Steering Angle	SASM - Steering Angle Sensor Module	●	●	●	●			●
Range Rover Sport	2005 - 2009	Chassis - Parking Brake	PBM - Park Brake Module	●	●	●	●			■
Range Rover Sport	2005 - 2009	Chassis - TPMS	TPMS - Tyre Pressure Monitoring System	●	●	◆	●			
Range Rover Sport	2005 - 2009	Chassis - ARCM	ARCM - Dynamic Response Module	●	●	●	●			
Range Rover Sport	2005 - 2009	Chassis - ATCM	ATCM - All Terrain Control Module	●	●	●	●			
Range Rover Sport	2005 - 2009	Chassis - Suspension	RLM - Ride Level Control Module	●	●	●	●			■
Range Rover Sport	2005 - 2009	Body - Airbag	RCM - Restraints Control Module	●	●	◆	●			
Range Rover Sport	2005 - 2009	Body - Climate Control	HVAC - Heating Ventilation Air Conditioning Control Module	●	●	●	●			
Range Rover Sport	2005 - 2009	Body - Body Controller	BCM - Body Control Module	●	●	●	●			●
Range Rover Sport	2005 - 2009	Body - Instruments	IPC - Instrument Panel Control Module	●	●	●	●			●
Range Rover Sport	2005 - 2009	Body - Lighting Control	FLM - Front Lighting Module	●	●	●	●			
Range Rover Sport	2005 - 2009	Body - Parking Aid	PAM - Parking Aid Module	●	●	◆	●			
Range Rover Sport	2005 - 2009	Body - Fuel Fired Heater	FFH - Fuel Fired Heater	●	●	●	●			
Range Rover Sport	2005 - 2009	Infotainment - Audio and Video	AAM - Audio Amplifier Module	●	●	●	●			
Range Rover Sport	2005 - 2009	Infotainment - Audio and Video	ACM - Audio Control Module	●	●	●	●			
Range Rover Sport	2005 - 2009	Infotainment - Audio and Video	FEM - Front Electronic Module	●	●	●	●			
Range Rover Sport	2005 - 2009	Infotainment - Audio and Video	DACMC - Digital Audio Control Module 'C'	●	●	●	●			
Range Rover Sport	2005 - 2009	Infotainment - Audio and Video	SRM - Satellite Audio Unit Module	●	●	●	●			
Range Rover Sport	2005 - 2009	Infotainment - Audio and Video	TVM - Television Module	●	●	●	●			

Lynx Vehicle Coverage - continued

Key to Lynx Version 2.6.2

- Existing feature
- Enhanced feature
- ◆ New feature

Vehicle Model	Years	System	System Name	Rear Fault Codes	Clear Fault Codes	Live Data	ECM Data	Actuators	Programming	Maintenance
Range Rover Sport	2005 - 2009	Infotainment - REM	REM - Rear Entertainment Control Module	●	●	●	●			
Range Rover Sport	2005 - 2009	Infotainment - TEL	TEL - Cellular Telephone Control Module	●	●	●	●			
Range Rover Sport	2005 - 2009	Infotainment - TMC	TMC - Traffic Message Channel Module	●	●	●	●			
Range Rover Sport	2005 - 2009	Service Functions - Service Reset	IPC - Instrument Panel Control Module		●					●
Range Rover Sport	2005 - 2009	Global Function - Clear DTCs	High Speed CAN Clear DTCs		●					
Range Rover Sport	2005 - 2009	Global Function - Clear DTCs	Medium Speed CAN Clear DTCs		●					
Range Rover Sport	2005 - 2009	Global Functions - ECU Reset	High Speed CAN ECU Reset							●
Range Rover Sport	2005 - 2009	Global Functions - ECU Reset	Medium Speed CAN ECU Reset							●
Range Rover Sport	2010 - 2011	Drive - Diesel EMS	PCM - Power Train Control Module (Diesel V6)	●	●	●	●			●
Range Rover Sport	2010 - 2011	Drive - Diesel EMS	PCM - Power Train Control Module (Diesel V8)	●	●	●	●			●
Range Rover Sport	2010 - 2011	Drive - Petrol EMS	PCM - Power Train Control Module (Petrol)	●	●	●	●			
Range Rover Sport	2010 - 2011	Drive - Transmission	TCM - Transmission Control Module (Diesel V6)	●	●	●	●			
Range Rover Sport	2010 - 2011	Drive - Transmission	TCM - Transmission Control Module (Diesel V8)	●	●	●	●			
Range Rover Sport	2010 - 2011	Drive - Transmission	TCM - Transmission Control Module (Petrol)	●	●	●	●			
Range Rover Sport	2010 - 2011	Drive - Transmission	RDCM - Rear Differential Control Module	●	●	●	●			
Range Rover Sport	2010 - 2011	Drive - Transfer Case	TCCM - Transfer Case Control Module	●	●	●	●			
Range Rover Sport	2010 - 2011	Drive - Adaptive Cruise Control	CCM - Cruise Control Module	●	●	●	●			
Range Rover Sport	2010 - 2011	Chassis - ABS / DSC	ABS / DSC - Antilocking brake System / Dynamic Stability Control	●	●	●	●			●
Range Rover Sport	2010 - 2011	Chassis - Steering Angle	SASM - Steering Angle Sensor Module	●	●	●	●			●
Range Rover Sport	2010 - 2011	Chassis - Parking Brake	PBM - Park Brake Module	●	●	●	●			●
Range Rover Sport	2010 - 2011	Chassis - ARCM	ARCM - Dynamic Response Module	●	●	●	●			
Range Rover Sport	2010 - 2011	Chassis - ATCM	ATCM - All Terrain Control Module	●	●	●	●			
Range Rover Sport	2010 - 2011	Chassis - Suspension	RLM - Ride Level Control Module	●	●	●	●			●
Range Rover Sport	2010 - 2011	Chassis - Suspension	ADCM - Adaptive Damping Control Module	●	●	●	●			
Range Rover Sport	2010 - 2011	Body - Airbag	RCM - Restraints Control Module	●	●	◆	●			
Range Rover Sport	2010 - 2011	Body - Airbag	OCS - Occupancy Classification System	●	●	◆	●			
Range Rover Sport	2010 - 2011	Body - Climate Control	HVAC - Heating Ventilation Air Conditioning Control Module	●	●	●	●			
Range Rover Sport	2010 - 2011	Body - Body Controller	BCM - Body Control Module	●	●	●	●			●
Range Rover Sport	2010 - 2011	Body - Instruments	IPC - Instrument Panel Control Module	●	●	●	●			●
Range Rover Sport	2010 - 2011	Body - Lighting Control	HCM - Headlamp Control Module	●	●	●	●			
Range Rover Sport	2010 - 2011	Body - Lighting Control	HCMB - Headlamp Control Module 'B'	●	●	●	●			
Range Rover Sport	2010 - 2011	Body - Parking Aid	PAM - Parking Aid Module	●	●	◆	●			
Range Rover Sport	2010 - 2011	Body - Immobiliser	Immobiliser	●	●	●	●			
Range Rover Sport	2010 - 2011	Body - Fuel Fired Heater	FFH - Fuel Fired Heater	●	●	●	●			
Range Rover Sport	2010 - 2011	Body - Seating	DSM - Drivers Seat Module	●	●	●	●			
Range Rover Sport	2010 - 2011	Body - Doors	DDM - Drivers Door Module	●	●	●	●			
Range Rover Sport	2010 - 2011	Body - Doors	PDM - Passengers Door Module	●	●	●	●			
Range Rover Sport	2010 - 2011	Body - KVM	KVM - Keyless Vehicle Module	●	●	●	●			
Range Rover Sport	2010 - 2011	Infotainment - Audio and Video	AAM - Audio Amplifier Module	●	●	●	●			
Range Rover Sport	2010 - 2011	Infotainment - Audio and Video	ACM - Audio Control Module	●	●	●	●			
Range Rover Sport	2010 - 2011	Infotainment - Audio and Video	FEM - Front Electronic Module	●	●	●	●			
Range Rover Sport	2010 - 2011	Infotainment - Audio and Video	CDP - Compact Disc Player	●	●	●	●			
Range Rover Sport	2010 - 2011	Infotainment - Audio and Video	DABM - Digital Audio Broadcast Module	●	●	●	●			
Range Rover Sport	2010 - 2011	Infotainment - Audio and Video	SRM - Satellite Audio Unit Module	●	●	●	●			
Range Rover Sport	2010 - 2011	Infotainment - Audio and Video	TVM - Television Module	●	●	●	●			
Range Rover Sport	2010 - 2011	Infotainment - APIM								

Lynx Vehicle Coverage - continued

Key to Lynx Version 2.6.2

- Existing feature
- Enhanced feature
- ◆ New feature

Vehicle Model	Years	System	System Name	Rear Fault Codes	Clear Fault Codes	Live Data	ECM Data	Actuators	Programming	Maintenance
Range Rover Sport	2012 - 2013	Infotainment - Audio and Video	FCDIM - Front Control/Display Interface Module	●	●					
Range Rover Sport	2012 - 2013	Infotainment - Audio and Video	FCIM - Front Control Interface Module	●	●					
Range Rover Sport	2012 - 2013	Infotainment - Audio and Video	FCIMB - Front Control Interface Module 'B'	●	●					
Range Rover Sport	2012 - 2013	Infotainment - IPMB	IPMB - Image Processing Module 'B'	●	●					
Range Rover Sport	2012 - 2013	Service Functions - Service Reset	IPC - Instrument Panel Control Module							●
Range Rover Sport	2012 - 2013	Global Function - Clear DTCs	High Speed CAN Clear DTCs		●					
Range Rover Sport	2012 - 2013	Global Function - Clear DTCs	Medium Speed CAN Clear DTCs		●					
Range Rover Sport	2012 - 2013	Global Functions - ECU Reset	High Speed CAN ECU Reset						●	
Range Rover Sport	2012 - 2013	Global Functions - ECU Reset	Medium Speed CAN ECU Reset						●	
Range Rover Evoque	2012 -	Drive - Diesel EMS	PCM - Power Train Control Module (Diesel)	●	●	●	●			●
Range Rover Evoque	2012 -	Drive - Petrol EMS	PCM - Power Train Control Module (Petrol)	●	●	●	●			
Range Rover Evoque	2012 -	Drive - Transmission	TCM - Transmission Control Module	●	●					■
Range Rover Evoque	2012 -	Drive - Transmission	GSM - Gear Shift Module	●	●					
Range Rover Evoque	2012 -	Drive - Transmission	GSMB - Gear Shift Module 'B'	●	●					
Range Rover Evoque	2012 -	Drive - Transmission	RDCM - Rear Differential Control Module	●	●					
Range Rover Evoque	2012 -	Chassis - ABS/DSC	ABS / DSC - Antilocking brake System / Dynamic Stability Control	●	●	●	●			
Range Rover Evoque	2012 -	Chassis - Steering Angle	SASM - Steering Angle Sensor Module	●	●	●	●			
Range Rover Evoque	2012 -	Chassis - Parking Brake	PBM - Park Brake Module	●	●					●
Range Rover Evoque	2012 -	Chassis - Power Steering	PSCM - Power Steering Control Module	●	●					
Range Rover Evoque	2012 -	Chassis - Suspension	ADCM - Adaptive Damping Control Module	●	●					
Range Rover Evoque	2012 -	Chassis - ATCM	ATCM - All Terrain Control Module	●	●					
Range Rover Evoque	2012 -	Body - Airbag	RCM - Restraints Control Module	●	●					
Range Rover Evoque	2012 -	Body - Airbag	OCS - Occupancy Classification System	●	●	◆				
Range Rover Evoque	2012 -	Body - Climate Control	HVAC - Heating Ventilation Air Conditioning Control Module	●	●					
Range Rover Evoque	2012 -	Body - Body Controller	BCM - Body Control Module	●	●					●
Range Rover Evoque	2012 -	Body - Instruments	IPC - Instrument Panel Control Module	●	●					●
Range Rover Evoque	2012 -	Body - Lighting Control	HCM - Headlamp Control Module	●	●					
Range Rover Evoque	2012 -	Body - Lighting Control	HCMB - Headlamp Control Module 'B'	●	●					
Range Rover Evoque	2012 -	Body - Parking Aid	PAM - Parking Aid Module	●	●					
Range Rover Evoque	2012 -	Body - Object Detection	SODL - Side Object Detection Control Module - Left	●	●					
Range Rover Evoque	2012 -	Body - Object Detection	SODR - Side Object Detection Control Module - Right	●	●					
Range Rover Evoque	2012 -	Body - Immobiliser	BCM - Body Control Module	●	●					
Range Rover Evoque	2012 -	Body - Fuel-Fired Heater	FFH - Fuel Fired Heater	●	●					
Range Rover Evoque	2012 -	Body - Seating	DSM - Drivers Seat Module	●	●					
Range Rover Evoque	2012 -	Body - Seating	PSM - Passenger Seat Module	●	●					
Range Rover Evoque	2012 -	Body - Doors	DDM - Drivers Door Module	●	●					
Range Rover Evoque	2012 -	Body - Doors	PDM - Passengers Door Module	●	●					
Range Rover Evoque	2012 -	Body - KVM	KVM - Keyless Vehicle Module	●	●					
Range Rover Evoque	2012 -	Body - RGTM	RGTM - Rear Gate/Trunk Module	●	●					
Range Rover Evoque	2012 -	Infotainment - Audio and Video	AAM - Audio Amplifier Module	●	●					
Range Rover Evoque	2012 -	Infotainment - Audio and Video	ACM - Audio Control Module	●	●					
Range Rover Evoque	2012 -	Infotainment - Audio and Video	FCDM - Front Control / Display Interface Module	●	●					
Range Rover Evoque	2012 -	Infotainment - Audio and Video	FCIMB - Front Control Interface Module 'B'	●	●					
Range Rover Evoque	2012 -	Infotainment - Audio and Video	DABM - Digital Audio Broadcast Module	●	●					
Range Rover Evoque	2012 -	Infotainment - Audio and Video	SRM - Satellite Audio Unit Module	●	●					
Range Rover Evoque	2012 -	Infotainment - Audio and Video	TVM - Television Module	●	●					
Range Rover Evoque	2012 -	Infotainment - REM	REM - Rear Entertainment Module	●	●					
Range Rover Evoque	2012 -	Infotainment - IPMB	IPMB - Image Processing Module 'B'	●	●					
Range Rover Evoque	2012 -	Service Function - Service Reset	IPC - Instrument Panel Control Module							●
Range Rover Evoque	2012 -	Global Function - Clear DTCs	High Speed CAN Clear DTCs		●					
Range Rover Evoque	2012 -	Global Function - Clear DTCs	Medium Speed CAN Clear DTCs		●					
Range Rover Evoque	2012 -	Global Functions - ECU Reset	High Speed CAN ECU Reset							●
Range Rover Evoque	2012 -	Global Functions - ECU Reset	Medium Speed CAN ECU Reset							●

Repair & Service

Keeping your Land Rover in good condition can require a range of specialist tools and service equipment. We have an extensive range of repair and service parts from engine oils to a complete chassis to ensure that your Land Rover gets the treatment it deserves!

Repair & Service Parts

Axle/Steering/Suspension	Transmission - continued
Air suspension compressors.....148	Diff overhaul kits.....160
Front hub, bearing & upright assembly.....149	Diff rebuild kit.....160
Steering box repair kit.....148	Diff repair pans.....157
Steering rack ball joint repair kits.....148	Gear boxes.....158
Stub axle kits.....148	Gear change kits.....158
Suspension ball joint repair kits.....149	Gearbox bearing kits.....158
Suspension bolt kits.....148	IRD repair kit.....158
Swivel housing kits.....148	Propshaft bearings.....158
Swivel pin kits.....148	Rear diff & carriers.....160
Wheel bearing kits.....149	Transfer boxes.....160
Wheel hub & bearing.....149	
Braking	Chassis & Body Components
Anti-squeal shims.....150	Chassis - Complete galvanised frames161
Brake fitting kit.....150	Chassis & body components
Brake kits.....150	Defender.....162
Brake lubrication.....150	Discovery 1.....163
Brake pipe sets.....150	Discovery 2.....163
Parking brake spring kits.....150	Range Rover Classic.....164
Stainless steel brake calliper pistons & kits.....152	Series 2 & 3.....165
XD brake pads.....151	Other.....166
XS brake discs.....152	Door hinge kits166
XS brake pads.....151	Door lock166
Electrics	Fuel latch repair kit166
Alternator upgrade kits.....153	Galvanised products161
Electronic conversion kits.....153	Window kits167
Ignition lead sets.....153	
Ignition module & link lead.....153	Service kits
Programmable wiper relay.....153	Automatic Transmission Fluid Change Kits172
Engine	Service Kits
Aluminium rockers.....156	Defender.....169
Bleed screws.....155	Discovery.....170
Cylinder heads.....154	Freelander.....170
Cylinder liner kit.....154	Range Rover.....171 - 172
Engines.....155	Series.....169
Exhaust fitting kits.....156	Service Stickers172
Filters - bulk.....154	
Fuel filter holder.....155	Consumables
Gaskets & head bolt sets.....154	Bearing Grease173
Heater plug upgrade kit.....155	Brake Cleaner173
Injector pipe sets.....154	Bulk Nuts, Bolts & Screws173
Injector washer kits.....155	Castrol Classic Oils175
Main bearing sets.....154	Clips, Clamps & Nipples173
Manifold inlet seal.....155	Loctite Consumables179
Oil cooler repair kit.....155	Hylomar Sealants & Compounds173
Oil pump gear set.....155	Oil Analysis Kit177
Piston & ring sets.....156	Raptor178
Pressure relief valve.....155	Ravenol Classic Oils179
Replacement plug.....156	Ravenol Workshop Consumables176 - 177
Td5 short oil filter.....155	Swivel Housing Grease173
Timing belt kits.....155	Touch Up Paint Pens175
Top hat liner set.....155	Trade Tack Stab173
Water sensor repair kit.....156	Workshop Consumables174
XS water pumps.....156	
Heating	Tools
Heater blower motor kit & resistor kit.....157	Automatic Transmission Flush & Fill Machine184
Heater matrixes.....157	Calibration Tools181
Transmission	Lighting184
Automatic transmission filter conversion & service kits.....157	Timing Tools181
Clutches.....159	Workshop Tools182 - 183
Clutch pedal assist.....158	
Crown wheel & pinion.....158	
CV joint kits.....158	
Damper kit.....157	
Detent repair springclip.....158	
Diff coupling shaft.....157	



Photo courtesy of Edwin Remsburg

Axle, Steering & Suspension

Swivel Housing Kits

Corroded, worn or leaking swivel housings?
These ten swivel housing kits from Britpart are a convenient way to ensure you have all the quality parts needed to replace a Land Rover's swivel housing.

Discovery 1 - up to JA32850 - with 12mm seals Range Rover Classic - from 1985 up to JA624516 - with 12mm seals	DA3163	DA3163P	DA3163G
Contents - Swivel housing; swivel pin bearing; gasket; seals; plate; shims; joint washers; swivel pin upper & swivel housing grease sachet			
Discovery 1 - up to JA32850 - with 8mm seals Range Rover Classic - up to JA624516 - with 8mm seals	DA3164	DA3164P	DA3164G
Contents - Swivel housing; swivel pin bearing; gasket; oil seals; plate; shims; joint washers; swivel pin upper & swivel housing grease sachet			
Discovery 1 - JA32851 onwards - non-ABS Range Rover Classic - JA624517 onwards - non-ABS	DA3165	DA3165P	DA3165G
Contents - Swivel housing; swivel pin bearing; gasket; seals; plate; shims; joint washers; swivel pin upper - non-ABS & swivel housing grease sachet			
Discovery 1 - with ABS Range Rover Classic - with ABS	DA3166	DA3166P	DA3166G
Contents - Swivel housing; swivel pin bearing; gasket; seals; plate; shims; joint washers; swivel pin kit - upper - ABS & swivel housing grease sachet			
Defender - up to KA930455	DA3167	DA3167P	DA3167G
Contents - Swivel housing; housing and bush; thrust washer; swivel pin bearing; joint washers; seals; shims; swivel pin upper & swivel housing grease sachet			
Defender - from LA up to WA	DA3178	DA3178P	DA3178G
Contents - Swivel housing; swivel pin bearing; gasket; seals; plate; shims; joint washers; swivel pin upper - non-ABS & swivel housing grease sachet			
Defender - XA onwards - non-ABS	DA3179	DA3179P	DA3179G
Contents - Swivel housing; swivel pin bearing; gasket; seals; plate; joint washers; swivel pin kit & swivel housing grease sachet		NEW DA3179PG OEM kit	
Defender - XA onwards - with ABS	DA3180	DA3180P	DA3180G
Contents - Swivel housing; swivel pin bearing; gasket; seals; plate; joint washers; swivel pin kit & swivel housing grease sachet			
Series 2	DA3169	DA3169P	
Contents - Swivel housing; swivel pin; railko bush; thrust washer; swivel pin bearing; o-ring; lock washer; locker; shims; oil seal; retainer for oil seal; joint washers & swivel housing grease sachet			
Series 2A/Series 3	DA3181	DA3181P	
Contents - Swivel housing; swivel pin; railko bush; thrust washer; swivel pin bearing; o-ring; lock washer; locker; shims; oil seal; retainer for oil seal; joint washers & swivel housing grease sachet			

Note Kit is for one side only. For full details of each kit list - www.britpart.com/swivelkits
Blue part numbers - full kit with swivel housing; **Red 'P' part numbers** - repair kit without swivel housing;
Green 'G' part numbers - full kit with swivel housing & OEM seals



DA3203
Defender castor corrected swivel housings
These are a direct replacement for vehicles normally using the FRC7065 swivel housing but they have the mounting holes positioned to give 3 degrees of additional castor. Full details in the suspension section.

Air Suspension Compressors

LR023964	LR078650
Discovery 3 - up to 9A513325 Range Rover Sport - up to 9A215622	Discovery 4 - from 9A513325 Range Rover Sport - from 9A215622
DA3965 NEW Complete compressor kit	LR072537 COMING SOON Complete compressor kit
LR015303 & LR023964 Compressor & relay	LR078650 NEW Compressor, relay, bracket & fixings
Range Rover L322 - from 6A198058 up to CA393639	LR045444 Compressor, relay & fixings
LR015089 & LR025111 Compressor & relay	LR044034 Bracket only
DA3964 NEW Hitachi compressor pipe/install kit	DA1888 NEW AMK compressor pipe/install kit

Full details on these compressors can be found in the suspension section.

Stub Axle Kits

DA3190 Defender - up to KA		<i>Handy kits when changing your Land Rover's stub axle!</i>
DA3191 Defender - from LA		
DA3192 Defender - from 2007 onwards		
DA3193 Discovery 1 - up to JA032850		
DA3194 Discovery 1 - from JA032851		
DA3195 Range Rover Classic - from JA624517		
Rear Kits		
DA3198 Defender 90 - from LA930456 Defender 110 - from WA769311		
DA3199 Defender - 110/130 from LA with Salisbury axle up to WA769310		
DA3358 Defender - up to KA. Up to axle 22S8283 NEW		
DA3359 Defender - up to KA. From axle 22S8283 NEW		
DA3196 Discovery 1 - up to JA032850/Range Rover Classic - up to JA032850		
DA3197 Discovery 1 - from JA032851/Range Rover Classic - from JA032851		

Steering Box Repair Kit

DA1236
DA1236 Series 2, 2A & 3

Steering Rack Ball Joint Repair Kits

LR010673
LR010673 Range Rover Sport 2005 - 2013 - M14 ball joints
LR010674 Range Rover Sport - 2005 - 2009 - M12 ball joints

Swivel Pin Kits

DA2178	DA2211
532268 Series 2 - conversion	
DA2178 Series 3	
DA2211 Defender - up to KA930455	
DA2210 Defender - from LA930456 up to WA159806	

Suspension Bolt Kits



DA7202 Defender - up to KA930455 Front suspension - radius arms & panhard rod bolts	DA7212 NEW Discovery 3/Discovery 4/Range Rover Sport - 2005 - 2012 Front upper suspension arm
DA7200 Defender - LA930456 to WA159806 Front suspension - radius arms & panhard rod bolts	DA7205 Discovery 3/Discovery 4/Range Rover Sport - 2005 - 2012 Front lower suspension arm
DA7203 Defender - XA159807 to 2A626645 Front suspension - radius arms & panhard rod bolts	Note - This kit includes a 1.5mm pitch threaded nut, please check the thread pitch on your drive shaft before changing. If you require the 2mm pitch nut please order LR024151.
DA7204 Defender - 2A625546 onwards Front suspension - radius arms & panhard rod bolts	DA7207 Discovery 3/Discovery 4/Range Rover Sport - 2005 - 2012 Rear upper suspension arm
DA7201 Defender - up to YA185790 Rear suspension - trailing arms & a-frame bolts	DA7206 Discovery 3/Discovery 4/Range Rover Sport - 2005 - 2012 Rear lower suspension arm
DA7208 Defender - YA185791 onwards Rear suspension - trailing arms & a-frame bolts	

Suspension Ball Joint Repair Kits



Using these replacement ball joint kits is a cost effective way to repair the Freelander front suspension arm.

Freelander 1 - up to 5A999999
RBJ102920/930BJ
RBJ102920/930BJG - OEM
Freelander 1 - from 6A000001
RBJ500680/690BJ
RBJ500680/690BJG - OEM
LR007205-6BJ
Freelander 2
Ball joint for LR007205 & LR007206
RBJ500680/690BJG
LR007205-6BJ

Suspension arm not included.

Wheel Hub & Bearing



LR014147
Wheel hub & bearing assembly kit - front
Discovery 3/Discovery 4
Range Rover Sport - 2005 - 2013

Front Hub, Bearing & Upright Assembly



Freelander 2
Replacement front hub, bearing & upright complete assembly. Offers a quick and cheaper alternative to replacing wheel bearing or hub as separate items, saving time and money.

DA1213 Right hand side
DA1214 Left hand side

Wheel Bearing Kits



DA2379	DA2379G	Series 2/Series 3 - SWB/LWB up to 1980 - imperial	Front & rear
DA2380	DA2380G	Series 3 - SWB/LWB - 1980 onwards - metric	Front & rear
DA2381	DA2381G	Defender - up to KA	Front
DA2382	DA2382G	Defender - up to KA	Rear
DA2383	DA2383G	Defender - LA onwards	Front & rear
DA2384	DA2384G	Discovery 1 - up to JA032850	Front & rear
DA2385	DA2385G	Discovery 1 - JA032851 onwards	Front & rear
DA2386	DA2386G	Range Rover Classic - non-ABS - up to JA624516	Rear
DA2387	DA2387G	Range Rover Classic - non-ABS - JA624517 on	Rear
DA2388	DA2388G	Range Rover Classic - ABS	Rear
FTC1507		Range Rover Classic - ABS	Front
		Range Rover Classic - non-ABS	Front
		Range Rover P38 Note - Bearing only	Front & rear



DA2386G	
----------------	--



Photo courtesy of Ray Cully

Braking

DA7202

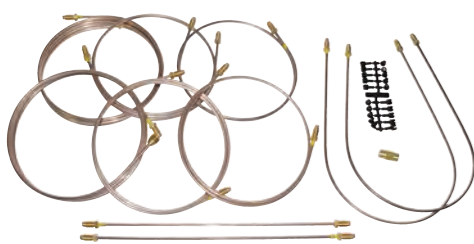

Ready Made Brake Pipe Sets

- > Easily fitted
 - > Will not rust
- Copper nickel brake pipe sets manufactured in the UK. Each kit is complete for a specific Land Rover model. Pipes are cut to the correct length, fitted with solid brass unions and marked clearly to indicate the correct location on the Land Rover. Pipe fitting clips and brass in-line connectors are supplied where necessary. More brake pipe kits available on request.



DA7440
Brake pipe bending tool. Can be used with all the brake pipe kits.

Brake Pipe Sets

DA7443	Series 1	RHD	80 inch
DA7442	Series 1	RHD	86 inch
DA7400	Series 2	SWB	RHD 1958 - 1961. From chassis 141900105 to suffix F inclusive 4-cylinder
DA7428	Series 2	SWB	LHD 1958 - 1969 suffix F. 4-cylinder from chassis 141900105 to suffix F
DA7429	Series 2A	SWB	LHD 1969 4-cylinder to suffix G
DA7401	Series 2A	SWB	RHD 4-cylinder up to 1969 suffix G
DA7402	Series 2A	LWB	RHD 09/1961 - 01/1969 4-cylinder up to suffix F
DA7405	Series 2A	LWB	RHD 6-cylinder with servo up to 1969 to suffix F
DA7406	Series 2A	LWB	RHD From 04/1969 suffix G. No servo 6-cylinder from suffix G.
DA7403	Series 3	SWB	RHD Single line 4-cylinder & 6-cylinder
DA7407	Series 3	SWB	RHD Dual lightweight up to 07/1980
DA7409	Series 3	SWB	RHD Dual to early 1980
DA7412	Series 3	SWB	RHD Lightweight dual up to 1975 with servo to chassis 95102970A
DA7413	Series 3	SWB	RHD Dual up to 07/1980. Civilian body metric & imperial system
DA7430	Series 3	SWB	LHD No servo
DA7432	Series 3	SWB	LHD Dual system
DA7404	Series 3	LWB	RHD 4-cylinder & 6-cylinder single line
DA7408	Series 3	LWB	RHD From 07/1980 & air portable lightweight from July 1980 onwards & 1981 V8 dual
DA7410	Series 3	LWB	RHD Up to 06/1980 dual. 4-cylinder up to 06/1980 & V8 up to 09/1980
DA7431	Series 3	LWB	LHD Single line 4-cylinder & 6-cylinder
DA7411	Defender	90	RHD 1985 - 1991 to VIN HA
DA7418	Defender	90	RHD With front brake valve less ABS LA930456 - WA159806
DA7441	Defender	90	RHD Less front brake valve less ABS LA930456 - WA159806
DA7439	Defender	90	LHD 1992 onwards from JA up to 2004
DA7420	Defender	110	RHD 1983 - 1987
DA7414	Defender	110	RHD 1988 - 1991 VIN HA90219
DA7438	Defender	110	RHD CSW from VIN KA & LA models from 1993
DA7419	Defender	130	RHD CSW from 1994 VIN LA
DA7415	Discovery 1	200Tdi	RHD Up to VIN JA 1992
DA7416	Discovery 1	200Tdi	RHD From VIN JA 1993
DA7417	Discovery 1	300Tdi	RHD From 1994 non-ABS
DA7433	Discovery 1	300Tdi	LHD From 1994 with ABS
DA7422	Range Rover Classic	RHD	Early models
DA7421	Range Rover Classic	RHD	From 1979 with rear valve
DA7434	Range Rover Classic	LHD	From 1979 with rear valve
DA7423	Range Rover Classic	RHD	Non-ABS from 1987 VIN DA274121 (2-door) & DA273923 (4-door) OSF valve
DA7424	Range Rover Classic	RHD	ABS 1986 up to VIN CA274120 (2-door) & CA273922 (4-door) front valve & bypass pipe
DA7435	Range Rover Classic	LHD	From 1987 non-ABS from VIN DA274121 (2-door) & DA273923 (4-door) front valve & bypass pipe
DA7436	Range Rover Classic	LHD	ABS front valve & bypass pipe 1986. 1983 up to VIN CA274120 (2-door) & CA273922 (4-door) 1986 onwards
DA7425	Range Rover Classic	RHD	ABS 1990 - 1991 VIN HA
DA7426	Range Rover Classic	RHD	ABS 1992 VIN JA
DA7427	Range Rover Classic	RHD	1993 VIN KA air suspension
DA7437	Range Rover Classic	LHD	Up to 1992 VIN HA with Clayton Dewandre Wabco 4-channel ABS

Anti-squeal Shims



DA1141
Universal self adhesive noise dampening shims.

The shims are manufactured from wolverine and cut to shape and applied to the backing plate of the brake pads prior to fitting to help eliminate any noise issues (should the pad be unshimmed). When used in conjunction with Mintex CeraTec silicon based lubricant, most brake noise related issues will be eradicated. Pack quantity 4.



Brake Fitting Kit

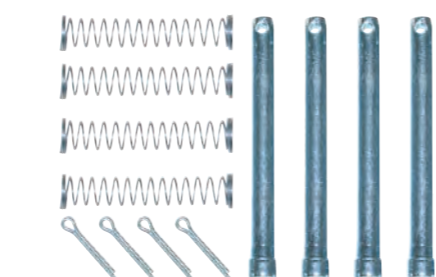

DA4105
Defender - 1987 - 2006
Brake fitting kit for rear brake pads STC1601 & SFP000280

Parking Brake Spring Kits

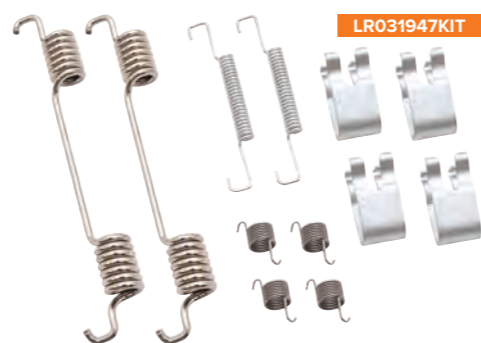

LR031947KIT
Discovery 4
Range Rover Sport - 2010 - 2013
SFS500012KIT
Discovery 3/Discovery 4
Range Rover Sport - 2005 - 2013

Britpart XD & XS Brake Pads

XD Brake Pads XS Brake Pads

Defender				
STC2952	STC2952G	1987 - 2006	Front	
SFP000260	SFP000260G	1987 - 2006 & 2007 -	Front	
SFP000280	SFP000280G	1987 - 2006	Rear	
STC1601	STC1601G	1987 - 2006	Rear	
SFP000250	SFP000250G	1987 - 2006 & 2007 -	Rear	
SFP000270	SFP000270G	1987 - 2006 & 2007 -	Rear	
LR032954	LR032954G	2007 -	Rear	
Discovery 1				
SFP500180	SFP500180G		Front	
STC9190	STC9190G		Front	
SFP500160	SFP500160G		Front	
SFP500190	SFP500190G		Rear	
SFP500200	SFP500200G		Rear	
STC9189	STC9189G		Rear	
Discovery 2				
SFP500150	SFP500150G		Front	
SFP500130	SFP500130G		Rear	
Discovery 3				
SFP500010	SFP500010G		Front	
LR019618	LR019618G		Front	
LR019627	LR019627G		Rear	
LR055454	LR055454G		Rear	
Discovery 4				
SFP500010	SFP500010G		Front	
LR019618	LR019618G		Front	
LR021253	LR021253G		Front	
LR051626	LR051626G		Front	
LR021316	LR021316G		Rear	
LR019627	LR019627G		Rear	
LR055454	LR055454G		Rear	
LR015519	LR015519G		Rear	
LR055455	LR055455G		Rear	
Discovery Sport				
LR072681 NEW	LR072681G NEW		Front	
LR061385 NEW	LR061385G NEW		Rear	
Freelander 1				
SFP100360	SFP100360G		Front	
LR021899	LR021899G		Front	
Freelander 2				
LR004936	LR004936G		Front	
LR003657	LR003657G		Rear	
LR023888	LR023888G		Rear	
LR043285	LR043285G		Rear	
Range Rover Classic				
SFP500180	SFP500180G	1986 - 1994	Front	
SFP500200	SFP500200G	1986 - 1994	Rear	
Range Rover P38				
SFP500120	SFP500120G	1994 - 2001	Front	
SFP500130	SFP500130G	1994 - 2001	Rear	

IMPORTANT BRAKE INFORMATION For exact change over points with vehicle applications please contact your local Britpart distributor with the full chassis number for the correct application. These references are intended as a guide only.

XD Brake Pads



- > Manufactured to OEM specifications ensuring long life and low noise in a TS16949 & ISO14021 approved factory.
- > Asbestos, lead & CR6 free material.
- > The XD Brake Pad range meet all official legislation for quality and safety and are compliant with European ECE R90.
- > All XD Brake Pads are produced with an underlayer material designed to dampen vibrations to prevent noise and to reduce heat transfer to the brake fluid.

The Britpart range of XD Brake Pads gives you the opportunity of fitting a much higher quality brake pad than the price would indicate. Britpart has tested many different brake pads over the last 5 years and have found this brake pad specification offers Land Rover owners the best possible performance at this price level.

The XD Brake Pads are manufactured to an exact tolerance using only the best European friction materials to OEM specifications ensuring long life and low noise. All raw materials are analysed in-house using a fully equipped quality laboratory with, for example, an atomic absorption device. After analysis the raw materials are mixed and pressed using several different methods to achieve the best brake pad for each application. Each part number is tailored to the application it is intended for. The XD Brake Pad range has been thoroughly tested on dynamometers and noise measuring rigs before being put through their paces on test tracks and extended operations tests to ensure a perfect and effective operation every time.

All pads are covered by the worldwide Britpart warranty and Britpart recommends they are fitted with the Britpart standard or performance brake discs.

XS Brake Pads



Best possible combination of long life, pedal feel and noise suppression.



The exact performance material specification of production line brake pads.

The Britpart range of XS Brake Pads offers you the opportunity to have the exact factory production line specification of brake pad at an affordable price. These pads offer the best possible combination of long life, pedal feel and noise suppression.

All the pads in the range use the same friction material specification that your Land Rover was originally made with.

The XS range of pads are all produced in one of the world's premium brake pad facilities where production procedures are carefully monitored to ensure a consistently good product.

The facility has both in-house testing and access to OE testing facilities to ensure all pads meet the exact specification required. Britpart XS Brake Pads are ideal for high mileage or heavy-duty applications.

XS Brake Discs NEW



XS Brake Disc

- > Exact OEM specification.
- > Low noise.
- > Installation ready - no need for cleaning before use.
- > Anti-corrosion coating which provides a long lasting clean appearance, ideal for today's open rims.
- > Disc run out - $\leq 0.08\text{mm}$
- > Unbalance requirement - $\leq 150\text{g}\cdot\text{cm}$
- > Coating - 5*20µm NA paint
- > Salt spray test - 120 hours



Photo courtesy of Roy Christie

Model	Year	Position	Type
Defender			
LR017951G / FRC7329G	1987 - 2006 & 2007 onwards	Front	Solid
LR017952G / FTC902G	1987 - 2006 & 2007 onwards	Front	Vented
FTC3846G	1987 - 2006	Rear	Solid
LR017953G / FTC1381G	1987 - 2006 & 2007 onwards	Rear	Solid
LR018026G / SDB000330G	1987 - 2006 & 2007 onwards	Rear	Solid
Discovery 1			
LR017951G / FRC7329G		Front	Solid
LR017952G / FTC902G		Front	Vented
LR017953G / FTC1381G		Rear	Solid
Discovery 2			
SDB000380G		Front	Vented
SDB000470G		Rear	Solid
Discovery 3			
SDB000614G		Front	Vented
SDB000604G		Front	Vented
SDB000646G		Rear	Vented
SDB000636G		Rear	Vented
Discovery 4			
SDB000624G		Front	Vented
SDB000604G		Front	Vented
LR025946G		Front	Vented
SDB000646G		Rear	Vented
SDB000636G		Rear	Vented
Discovery Sport			
LR059122G		Front	Vented
LR007055G		Front	Vented
LR061388G		Rear	Solid
Freelander 1			
SDB100830G	Up to YA999999	Front	Solid
SDB101070G	1A000001 onwards	Front	Vented
Freelander 2			
LR000470G / LR027107G	Petrol	Front	Vented
LR001019G	Petrol	Rear	Vented
LR007055G	Diesel	Front	Vented
LR001018G	Diesel	Rear	Solid
LR039935G	From DH000001	Rear	Solid
Range Rover Classic			
LR017951G / FRC7329G	1986 - 1991	Front	Solid
LR017952G / FTC902G	1986 - 1994	Front	Vented
LR017953G / FTC1381G	1986 - 1994	Rear	Solid
Range Rover P38			
NTC8780G	1995 - 2002	Front	Vented
SDB000470G	1995 - 2002	Rear	Solid
Range Rover Sport			
SDB000614G	2005 - 2009	Front	Vented
SDB000604G	2005 - 2009	Front	Vented
SDB000624G	2005 - 2013	Front	Vented
LR025946G	2010 - 2013	Front	Vented
SDB000646G	2005 - 2013	Rear	Vented
SDB000636G	2005 - 2009	Rear	Vented
LR016192G	2010 - 2013	Rear	Vented
LR016176G	2014 onwards	Front	Vented
LR038934G	2014 onwards	Front	Vented
LR033303G	2014 onwards	Rear	Vented
LR033302G	2014 onwards	Rear	Vented
Range Rover L322			
SDB000201G		Front	Vented
SDB500182G		Front	Vented
LR031843G / SDB500193G		Front	Vented
LR031845G		Front	Vented
SDB000211G		Rear	Solid
LR031844G / SDB500202G		Rear	Vented
LR016176G	2010 - 2012	Front	Vented
LR031846G	2010 - 2012	Rear	Vented
Range Rover L405			
LR016176G		Front	Vented
LR038934G		Front	Vented
LR033303G		Rear	Vented
LR033302G		Rear	Vented
Range Rover Evoque			
LR007055G		Front	Vented
LR027123G		Rear	Solid
LR059122G	17" wheel	Front	Vented

Electrics

Electronic Conversion Kits

ETC5835K
The Britpart electronic conversion kit replaces the existing points and condenser with a new reliable electronic module. For 4-cylinder petrol engines the Britpart electronic ignition module has been developed to work with the standard ignition coil and provides service free and accurate ignition timing. The kit can be easily fitted to standard points type 45D4 distributors. We'd recommend fitting a new coil at the same time - PRC9858. Also available a new distributor with points to which this kit can be fitted - ETC5835.

ERC4536K

This electronic conversion kit is for V8 points and has built in dwell adjustment with rpm protection when not running.

ETC5835K



ERC4536K



Alternator Upgrade Kits

DA1195



200Tdi alternator upgrade kits. Kits include uprated cable.
DA1195 Defender - 200Tdi Upgrade the 45A alternator to 100A
DA1196 Discovery 1 - 200Tdi Upgrade the alternator to 100A

NEW Sign up to the regular Britpart newsletter to find out about all the latest product releases. www.britpart.com/newsletter

Ignition Lead Sets

Defender - 4.0 V8
 Range Rover P38 - V8 - up to 1999
DA4102 Grey leads
DA4102RED Red leads
 Discovery 1 - V8
 Range Rover Classic - V8
Note - Includes king lead
DA4104 Grey leads
DA4104RED Red leads
 Discovery 1 - V8 / Range Rover Classic - V8
STC9124 Grey lead
 King lead with protective & waterproof rubber coil cover
 Defender - 3.5 V8
 Discovery 1 - 3.5 V8 carb & 3.5 V8 Efi
 Range Rover Classic - 3.5 V8 carb
 Range Rover P38 - 3.5 V8 Efi
RTC6551 Grey leads
RTC6551RED Red leads
Note - Includes king lead
 Range Rover P38
 Discovery 2 - 1999 onwards
NGC103740/810 Grey leads
NGC103740/810RED Red leads
DA5684 NEW Red leads
 Range Rover P38 - 4.6V8 1994 - 1998
NGC500370/410
 Freelander 1 - 1.8K Grey leads

DA4102



DA4104RED



STC9124



These silicone HT lead sets are designed to meet or exceed the original equipment specification. The silicon cable has minimal interference with maximum suppression, it is also resistant to water, oils, chemicals and high temperatures. High quality with ISO 3808 class noise suppression performance.

DA5684



NGC103740/810



NGC500370/410



Ignition Module & Link Lead

STC1184K

Module for V8 distributor
 Kit to convert 3-pin to 2-pin applications



Programmable Wiper Relay

AMR2341DELAY

Fed up with your Defender's intermittent wipers not being intermittent enough? Does it drive you mad when you give the screen a quick spray and it wipes for ages?

Fit this new relay in place of the standard AMR2341 to your vehicle to solve this problem. Once fitted you press the stalk down so that the wiper wipes and then back off again, now count/ wait till you want another wipe, switch the stalk down and

leave it on, this timing will now remain constant till you set another timing the same way or turn off the ignition at which point the relay reverts to a standard 6 second wipe interval. Another bonus is that the wipers will now only wipe once following a short burst of washer fluid or 3 times after a long burst. This will work on all Defenders with the latching intermittent wiper stalk PRC7370 or AMR6106 HA onwards (stays down when pressed) but it will also work on 300Tdi and Td5 although on post 2002 Td5s the relay AMR2341 is located behind the speedo. Will not work with early stalk PRC3900 up to GA models.

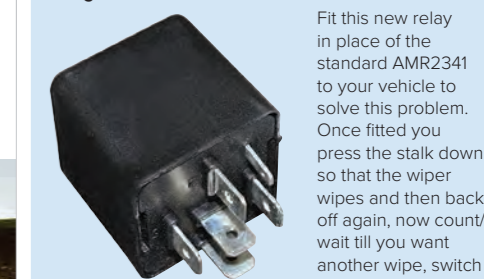

Stainless Steel Brake Calliper Pistons & Kits

Stainless steel brake calliper piston kits
 Each kit is one complete axle, either front or rear as stated. The kit includes OEM repair kit and grease sachet.

DA1165	Defender - up to HA701009/Discovery 1/Range Rover Classic	Front
DA1166	Defender - HA701010 onwards	Front
DA1167	Defender - 90/Discovery 1/ Range Rover Classic	Rear
DA1172	Defender - 110/130	Rear
Single stainless steel pistons		
606683S	Defender - up to HA701009/ Discovery 1/Range Rover Classic	Front
606696S	Defender - 90/Discovery 1/Range Rover Classic	Rear
STC201S	Defender - HA701010 onwards	Front
	Defender - 110/130	Rear

DA1165



DA1167



Engine



AEU2147LX
Minimum order quantity - 50 filters

Bulk Filters

- ESR4238X**
Defender - 1987 - 2006
Discovery 2 - 1998 - 2004/Freelander 1
Range Rover P38
Air filters
- AEU2147LX**
Defender/Discovery 1
Range Rover Classic - 1986 - 1994
Fuel filters
- ESR4686X**
Defender/Discovery 2
Fuel filters
- ERR3340X**
Defender/Discovery 1/Discovery 2
Range Rover Classic/Range Rover P38
Oil filters
- JKR500020X**
Discovery 3/Discovery 4
Range Rover Sport - 2005 - 2013
Pollen filters- odour & particles
- ERR6299X**
Defender/Discovery 2
Rotor filters

Cylinder Heads

Complete 300Tdi cylinder heads. Supplied with valves and head bolts, pressure tested and with heat tell tale stickers on.

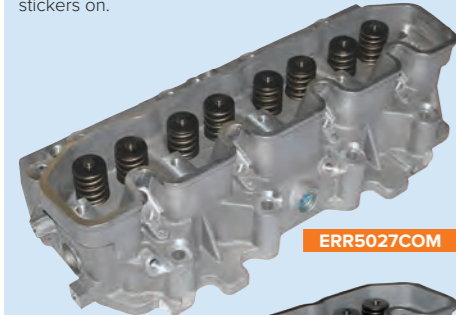

ERR5027COM



LDF500180COM

Note - This head has additional waterways for improved cooling. Use multi-leaf metal head gasket (LVB500220 - 3-hole) with this head.

Injector Pipe Sets

- Set of 4 injector pipes per kit
563165/6/7/8
Series - 2.25 diesel
Defender - 2.25 diesel
- ETC4291/2/3/4**
Defender 2.5 diesel & 2.5 diesel turbo
- STC793/4/5/6**
Defender - 200Tdi
- RTC6732/3/4/5**
Discovery 1
Range Rover Classic - 200Tdi
- STC1694/5/6/7**
Defender - 300Tdi - Less EDC
Discovery 1 - 300Tdi - Less EDC
Range Rover Classic - 300Tdi - Less EDC



STC1964/5/6/7

Cylinder Liner Kit



LCJ00050LKIT
Liner and piston for 1.8 litre K-series engines.

Main Bearing Sets

- DA5121**
Defender - 2.4 Puma
Standard size set
- DA5121AE**
Defender - 2.4 Puma
Standard size Glyco brand set
- DA5121025AE NEW**
0.25mm size Glyco brand set
- DA5121050AE NEW**
0.50mm size Glyco brand set
- DA5714**
Discovery 3 - 2.7 TdV6
Range Rover Sport - 2.7 TdV6
Undersize 0.5mm main bearing set and big ends
- DA5120**
Standard size set
Freelander 1 - K-Series 1.8 engine



Engines

- Complete Engines**
Include fuel pump, injectors, injector pipes, timing assembly and bell housing. Complete engines are tested prior to despatch. Once tested the flywheel and manifolds are removed and the engine is packed without these parts. Outer timing covers, pulleys, manifolds, flywheel and turbo charger are not included.
- Stripped Engines**
Include sump, block, cylinder head, rocker cover, inner timing cover, camshaft and crankshaft gear.
- Engines - New**
- DA1183 NEW**
Defender - 2.2 Puma
Stripped
- DA1182**
Defender - 2.4 Puma
Stripped
- DA2039**
Freelander 1 - 1.8K
Complete
- Engines - Reconditioned**
- DA4250DIS**
Discovery 1 - 200Tdi
Complete



Bleed Screws



- PYP10008RED**
Smart replacement anodised aluminium bleed screws for the top hose on a Td5 engine.
- PYP10008BLUE**
Blue
- PYP10008RED**
Red

Td5 Short Oil Filter



- LPX100590XD**
Td5 oil filter. Shorter than the standard filter which makes this one much easier to fit and remove.

Save time & effort with this easier to fit filter

Heater Plug Upgrade Kit



- DA1057**
Series - 2.25 diesel engine
DA1057PLUG
Replacement heater plug set for DA1057

Manifold Inlet Seal



- LR004404S**
Defender - Puma
Manifold inlet seal. This is not available as a separate part from Land Rover.

Pressure Relief Valve



- DA2376**
300Tdi oil pump relief valve kit for Defender/ Discovery 1/Range Rover Classic

Gaskets & Head Bolt Sets

- Head & Bottom Gasket Kits**
- DA2112**
Td5
Head set
No head gasket
- DA2112-1**
Td5
Head set
1-hole gasket
- DA2112-2**
Td5
Head set
2-hole gasket
- DA2112-3**
Td5
Head set
3-hole gasket
- DA2113**
Td5
Bottom set
- DA2112G-EARLY**
Td5
Etring head set
No head gasket
- DA2112G-LATER**
Defender - up to 1A622423 & Discovery 2 - up to 1A736339
Td5
Etring head set
No head gasket
- DA2508**
Defender - Puma 2.4
Head set
No head gasket
- DA2114**
Freelander 1 - 1.8 16v
Head set
Inc. head gasket
- DA2115**
Freelander 1 - 1.8 16v
Bottom set
- DA3143**
Freelander 1 - 2.5KV6
Head set
Inc. head gasket
- DA3145**
Freelander 1 - 2.0 diesel L series
Head set
No head gasket
- Head Gasket Kits & Head Bolt Sets**
- STC1172B**
200Tdi
No head gasket
- STC2802B**
300Tdi
No head gasket
- DA2112B**
Td5
No head gasket
- DA2114B**
Freelander 1 - 1.8 16v
Inc. head gasket
- Cam Cover Gasket Kit**
- DA5128 NEW**
2.2 diesel cam cover gasket set
Freelander 2
- Discovery Sport
Range Rover Evoque

- Head Bolt Sets**
- DA2006**
200Tdi engines
- DA2005**
300Tdi engines
- DA3356 NEW**
1.8K Series engines
- DA3357 NEW**
2.0l Tcie engines
- DA3367 NEW**
TdV6 engines
- DA3368 NEW**
TdV8 engines
- DA2505**
Defender - Puma 2.4
- DA2506**
Defender - Puma 2.2
- DA2141**
4.0/4.6 V8 ten bolt heads
2.2 diesel engines
Freelander 2
- DA3369 NEW**
Discovery Sport
Range Rover Evoque



DA2112



DA2112G-LATER

Many more images available online at www.britpart.com



STC1172B



DA2114B



DA5128



DA2005



DA3357



DA3369

Fuel Filter Holder



- DA1159**
Defender - 2007 onwards
Replacement fuel filter holder

Oil Pump Gear Set



- DA4189**
Oil pump gear set for V8 engines
Discovery 1/Discovery 2/Range Rover P38

Oil Cooler Repair Kit

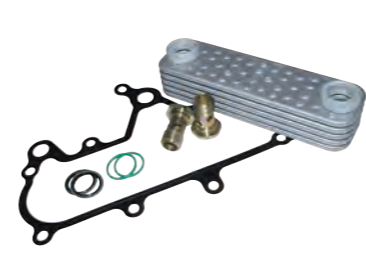

- DA1127**
Td5 oil cooler repair kit, to replace leaking oil cooler found in all Td5 engines, part of the PBC500230 assembly. Replace just the faulty cooler and not the casting which normally is perfectly serviceable, includes all hardware required. All manufactured to exactly OEM specification.

Top Hat Liner Set



- DA1185**
This flanged repair liner is suitable for damaged/porous 3.9/4.0/4.2/4.6 Rover V8 blocks. The block will require re-boring and flange recess machining before fitting. This liner is the complete solution for fixing these blocks. The liner can be bored to 96.00mm for over-bored versions of the V8 engine, taking it to 5.0 litres. Semi finished bore 94.00mm (less 1.00mm for final finishing in bore).
- Dimensions**
Inside diameter - 94.00mm; outside diameter - 99.06mm; length - 135.64mm; flange - diameter - 105.23mm; flange depth - 5.33mm

Timing Belt Kits

- DA1200DEF NEW**
Defender - 200Tdi
- DA1200DEFG NEW**
Defender - 200Tdi
OEM tensioner
- DA1200DIS NEW**
Discovery 1/Range Rover Classic - 200Tdi
- DA1200DISG NEW**
Discovery 1/Range Rover Classic - 200Tdi
OEM tensioner
- DA1300**
300Tdi engines
- DA1264G NEW**
Defender 2.5D & 2.5TD
OEM kit
- DA1261G NEW**
Freelander 1 - 1.8
Manual tension
OEM kit
- DA1265G NEW**
Freelander 1 - 1.8
Automatic tension
OEM kit
- DA1262G NEW**
Freelander 1 - 2.0Tcie
114 teeth
OEM kit
- DA1263G NEW**
Freelander 2 - 2.0Tcie
112 teeth
OEM kit



Injector Washer Kits

- Td5 injector washer kits with O-rings and washers
- DA2479LR**
Genuine set
- DA2479G**
OEM set
- DA2479**
Britpart set

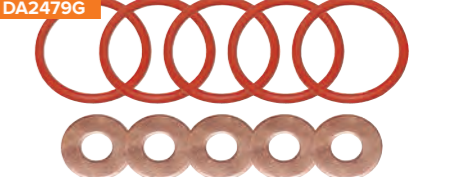

Piston & Ring Set NEW

Aluminium Rockers NEW

Water Sensor Repair Kit NEW



DA5127 NEW
Individual standard piston fitted with ring set.
Discovery 3 - 2.7 TdV6/Range Rover Sport - 2.7 TdV6
DA5126 NEW
Piston ring set.
Discovery 3 - 2.7 TdV6/Range Rover Sport - 2.7 TdV6

602153A NEW
602154A NEW
Defender - 1987 - 2006
Discovery 1
Discovery 2
Range Rover Classic - 1986 - 1994
Range Rover P38 - 1994 - 2001

LR045519REPAIRKIT NEW
Discovery 4
Range Rover Sport - 2010 - 2013

XS Water Pumps NEW



LR013164 Defender - 2007 onwards
LR013164 NEW Discovery 4/Range Rover Sport - 2010 - 2013 & 2014 onwards
PEB102240LG NEW Range Rover L405/
PEB102420LG NEW Freelander 1
PEB500090G NEW Discovery 1/Freelander 1
PEM500040G NEW Defender - 1987 - 2006/Discovery 1
STC483G NEW Defender - 1987 - 2006/Discovery 2
STC637G NEW Defender 1987 - 2006/Discovery 1/Discovery 2/Discovery 3
STC3758G NEW Range Rover Classic - 1992 - 1994
STC4378G NEW Range Rover Sport - 2005 - 2009
Range Rover L322 - 2002 - 2009
Defender - 1987 - 2006
Series 2A/Series 3 - 2.25l - 9-stud
Defender - 1987 - 2006 & 2007 onwards/Discovery 1
Discovery 2/Range Rover P38



Replacement Plug NEW

Exhaust Fitting Kits NEW



Replace your existing filler plug with one of these smart anodised aluminium ones. Suitable for use on a Defender, Discovery 1 & Range Rover Classic on the radiator and thermostat housing. Can also be used on the diff filler level on a Discovery 2.
ERR4686BLUE NEW
ERR4686RED NEW



All you need to replace the exhaust on a Series - SWB.
DA1293 NEW Right hand drive
DA1294 NEW Left hand drive



Got a great photograph of your Land Rover?
Why not enter the Britpart calendar competition for your chance to make your Landy a star. Full details can be found here - www.britpart.com/calendar

Heating

Heater Blower Motor Kit & Resistor Kit

DA4178
Range Rover Classic - 1990 - 1994 - 200Tdi with air con
Discovery 1 - 200Tdi with air con
Atlantic British has developed this all inclusive kit designed and engineered to replace failed heater motors. The kit includes heater blower motor, blower wheel, motor mounting bracket and mounting screws, heater assembly seals, nylon ties, solder, shrink tubing (for soldered connections) and complete instructions. **Note** - When replacing the heater blower motor the vehicle's resistor must be upgraded to DA4178RESISTOR.



DA4178RESISTOR
The air con blower motor resistor controls the speed of the blower motor and the force of the airflow out of the dash vents, it features a thermal-sink aluminium mounting plate that dissipates circuit heat effectively.

Heater Matrixes

DA2155 Series 3
AAP817 Defender - downward facing pipes
UTP1725 Defender - horizontal inlet/outlet pipes
JEF100220 Defender - LHD - XA159807 onwards
STC250 Discovery 1/Range Rover Classic - 1986 - 1994
STC3135 Discovery 1/Range Rover Classic - 1992 - 1994
JEF100150 Freelander 1 - up to YA999999
STC3261 Range Rover P38
More images online at www.britpart.com



Transmission

Diff Repair Pans



DA1043 Front - includes filler plug
Defender/Discovery 1/Range Rover Classic/Series
DA1044 Rear - includes filler plug
Defender 90/Discovery 1/Range Rover Classic/Series
DA1045 Front & rear - excludes filler plug
Series - early models

Automatic Transmission Filter Conversion & Service Kits

Degradation in oil can lead to judder, noise and a deterioration in gear change quality. ZF recommend oil and filter changes after 50,000 to 75,000 miles on automatic gearboxes to ensure optimum performance.
This is an easy change filter conversion kit for all vehicles using the ZF 6HP26 automatic transmission - Discovery 3, Discovery 4, Range Rover Sport - 2005 - 2013 and Range Rover L322 models. From the factory a fluid and filter change on this transmission is a very lengthy process. The sump and filter are normally one piece and fitting involves jacking the engine up and unbolting the mounts, plus the removal of the exhaust. **The fitting of this kit is far easier.** Once the fluid has been drained from the transmission simply remove the bolts from the old unit. Cut the old plastic sumps filter tube with a hacksaw. Slide the old sump out and remove the other end of the sawn off filter tube. The new separate filter can then be fitted and the new sump pan slides into place and is bolted up with the new gasket supplied. Once secure the transmission can be filled as per manufacturer's instructions. The new sump pan also has the added benefit that it is manufactured in durable steel rather than the plastic of the original item - LR007474. Also see DA6085 & DA6085G in service kit section. 7ltrs needed for oil change.

NEW Sign up to the regular Britpart newsletter to find out about all the latest product releases.
www.britpart.com/newsletter

Britpart		OEM	
DA2142	Filter conversion kit	DA2142G	Filter conversion kit - OEM
DA2143	Replacement filter	DA2143G	Replacement filter - OEM
DA2144 NEW	Replacement gasket	DA2144G	Replacement gasket - OEM
TYK500050	Ravenol fluid - 1 litre	TYK500050G	ZF Lifeguard fluid - 1 litre

Damper Kit

Diff Coupling Shaft



DA2352
Freelander 1 - up to 2006 4-cylinder
Not all viscous coupling problems are the fault of the unit itself, sometimes the damper is at fault, this kit prevents buying the whole coupling, just to replace the damper.

We are now able to offer a cheaper alternative!

DA2355
The Range Rover L322 - 2002 onwards, suffer from a common problem with the coupling shaft spline wearing between the front propshaft and front differential, thus losing drive to the differential. The problem relates to the coupling shaft, the differential itself is not affected. Currently the only solution offered by Land Rover is to replace the propshaft and the whole complete front differential assembly - a very expensive option! Using this new coupling shaft will enable you to replace just the propshaft and coupling shaft and leave the differential in place, therefore reducing both time (the differential need not be removed from the vehicle) and cost.



DA4500
Service kit for 4-speed gearbox. Kit comprises of oil screen, seals, o-rings and sealing washer.
Defender - up to 2007/Discovery 1
Discovery 2/Range Rover Classic
Range Rover P38

DA1113
Service kit for 5-speed gearbox. Kit comprises of oil screen, seal & o-ring.
Range Rover L322 - 4.4 V8



facebook.com/britpart

CV Joint Kits

Britpart has put together these boxed kits to help the fitter have all the necessary parts to do the job in one hit, saving time and money trying to find the necessary parts to do the job. These kits are also helpful to pass over the trade counter instead of having to hunt for the individual parts. One kit does one CV joint.

DA6050	Range Rover Classic - up to 1985
DA6051	Range Rover Classic - 1986 up to 1988 non-ABS axle suffix A up to EA305589
DA6052	Range Rover Classic - 1989 up to 1991 non-ABS axle suffix B from EA305590 up to HA610293
DA6053	Range Rover Classic - 1992 on non-ABS up to JA624755
DA6054	Range Rover Classic - 1986 up to 1991 with ABS up to HA610293
DA6055	10 spline on half shaft to diff end
DA6056	Range Rover Classic - 1992 on non-ABS from KA624756 up to P38
DA6057	Range Rover Classic - 1992 on with ABS up to P38
DA6058	24 spline on half shaft to diff end
DA6059	Range Rover Classic - 1992 on non-ABS from KA624756 up to P38
	Range Rover Classic - 1992 on with ABS to P38
DA6056	Range Rover P38 - 1995 up to 2002
DA6057	10 splines axle shaft to diff end
DA6058	Defender - non-ABS with 23 internal splines
DA6059	10 splines axle shaft to diff end
	Defender - 1986 on non-ABS with 32 internal splines
DA6059	24 splines axle shaft to diff end
	Defender - non-ABS and ABS models from LA up to 2007



DA6060	Discovery 1 - non-ABS up to JA32850
DA6061	10 splines axle shaft to diff end
DA6062	Discovery 1 - non-ABS JA032851 onwards
DA6063	24 splines axle shaft to diff end
DA6064	Discovery 1 - non-ABS - JA032851 onwards
	Discovery 1 - ABS models - JA032851 onwards
DA6063	Discovery 2
DA6064	Freelander 1 - up to YA999999 TCIE diesel and 1.8 petrol

Save time & money with a Britpart CV joint kit.

Gear Boxes



Gear Boxes - New			
TRC103150	Defender - LT77 - 50A suffix L		
TRC102900	Freelander 1 - Petrol 1.8K16		
Gear Boxes - Reconditioned			
DA3050	Defender - 4-cylinder up to 200Tdi	LT77/S	50G/H
DA3051	Defender - 200Tdi	LT77/S	56G/H
TRC103160E	Defender - 300Tdi	R380	56J
DA3058	Defender - Td5	R380	68A
LR039149	Defender - 2007 onwards	6-speed	
DA3052	Discovery 1 - 200Tdi	LT77/S	55G/H
DA3054	Discovery 1 - 300Tdi	R380	55J
TRC103350E	Discovery 2 - diesel - less oil cooler		
DA3055	Range Rover P38 - diesel	R380	65J

Gearbox Bearing Kits



DA3364	Series 3
DA3360 NEW	Series 2A
DA3362 NEW	LT77 suffix A - E
DA3363 NEW	LT77 suffix F - G
DA3364 NEW	LT77 suffix H
DA3365 NEW	R380 suffix J
DA3366 NEW	R380 suffix K

Gear Change Kits



Crown Wheel & Pinion



DA1252	LT77 gearbox
	Range Rover Classic - up to LA
	Discovery 1 - up to LA
DA1253	R380 gearbox
	Range Rover Classic - MA onwards
	Discovery 1 - MA onwards
	Discovery 2

TAG000230CWP NEW	Freelander 1
	Replacement crown wheel & pinion for IRD TAG000230.

Detent Repair Springclip



DA6247
Detent repair springclip to fit Discovery 3 & Discovery 4 manual gearboxes. Experiencing problems engaging reverse gear? To save expensive gearbox repairs or replacements it may just be this simple clip has broken. It is easily checked and replaced without any removal of the gearbox itself.



Clutch Pedal Assist Kit



DA1266 NEW
Replace the old clutch pedal spring kit to assist the pressing of the clutch pedal on Defender models. This is a factory fit on later models but can be retro fitted to all 90/110 models. Consists of spring, spring retainer & spring bushes

IRD Repair Kit



DA6440
Freelander 1
Repair kit for intermediate reduction drive assembly (TAG000230)

Clutches

Changing your clutch?

Then demand your dealer uses a clutch kit from Britpart!

- > Extensive testing ensures the ultimate specification.
- > Premier friction material gives longer life.
- > Self centring bearing provides smooth operation.
- > Intense quality control ensures fit first time.

For many more clutch images available at www.britpart.com/clutches



Heavy-duty Clutches & Parts

DA5551	Defender/Discovery 1/Range Rover Classic - 200/300Tdi	Heavy-duty clutch kit - plate, cover & bearing
DA5551G	Defender/Discovery 1/Range Rover Classic - 200/300Tdi	OEM heavy-duty clutch kit - plate, cover & bearing
DA5551KIT	Defender/Discovery 1/Range Rover Classic - 200/300Tdi	Heavy-duty clutch kit - plate, cover, heavy-duty bearing & heavy-duty clutch fork
DA5552	Defender/Discovery 1/Range Rover Classic - 200/300Tdi	Heavy-duty clutch kit - plate, cover, less bearing
DA2357HD	Britpart	Heavy-duty clutch kit - plate, cover, heavy-duty flywheel & bearing
DA2357HDG	AP Driveline	Heavy-duty one-piece dual mass replacement flywheel designed to outlast the original. Kit also includes modified release bearing. Note - Fitting this kit will increase gearbox noise.
DA2357CP		Replacement clutch kit for DA2357HD
LR072972 NEW	Defender - 2007 onwards	Up-rated clutch kit - plate & cover
PSD103470BRG		Replacement clutch release bearing for DA2357HD
FTC2957HD	Defender/Discovery 1/Range Rover Classic - various	Clutch release bearing - heavy-duty
FTC2957HDKIT	Defender/Discovery 1/Range Rover Classic - diesel only/non-V8	Clutch fork - heavy-duty
FTC5200HD	Various applications	Clutch fork installation kit - heavy-duty
	Defender - 1987 - 2006/Discovery 1/Discovery 2/Range Rover P38	Includes heavy-duty clutch fork, slipper pads, bush, staple & clip
		Clutch release bearing - heavy-duty



Standard Clutches & Parts

DA5550	Defender/Discovery 2 - Td5	Clutch kit - plate, cover & bearing
DA5550G	Defender/Discovery 2 - Td5	Clutch kit - OEM - plate & cover less bearing
DA2357	Defender/Discovery 2 - Td5	Clutch kit - plate, cover, flywheel & bearing
DA2357G	Defender/Discovery 2 - Td5	Clutch kit - Valeo - plate, cover & flywheel
STC8358	Defender - diesel (non-Td5)/Discovery 1 - diesel/Range Rover Classic	Clutch kit - plate, cover & bearing
LR012199	Defender - 2007 onwards	Clutch kit - plate & cover
LR012199C	Defender - 2007 onwards	Clutch cover
LR012199P	Defender - 2007 onwards	Clutch plate
STC8363	Series 3	Clutch kit - plate, cover & bearing
DA2369	Series 2A	Clutch kit (9") - plate & cover
DA2370	Series 2A	Clutch kit (9 1/2") - plate & cover
EST110075/76KIT	Santana - 2.8 Anibal PS10	Clutch kit - Borg & Beck - plate, cover & bearing
URB500060	Freelander 1 - 2.0 Tcie	Clutch kit - plate, cover & bearing
URB500060B NEW	Freelander 1 - 2.0 Tcie	Clutch kit - Borg & Beck - plate, cover & bearing
DA5558	Freelander 2 - 2.2 diesel	Clutch kit - plate, cover & concentric slave cylinder
LR008556	Freelander 2 - up to AH999999	Clutch kit OEM - plate & cover
DA5559	Freelander 2 - BH000001 onwards/Range Rover Evoque	Clutch kit - OEM - plate, cover & concentric slave cylinder

Dual mass flywheel conversion kit
The flywheel conversion kit can be used to replace the dual mass flywheel using a solid metal flywheel and a heavy duty clutch kit. The one piece flywheel will not break up like the dual mass one so it is highly likely you will never need to change it again which means - lower cost, ease of fitting & potentially eliminating any future flywheel failures.

Note - This kit will make the gearbox more audible in the car at tick over and the kit doesn't include the release bearing - UUB000070.

DA6250	Freelander 1 - 2.0 Td4	Dual mass flywheel conversion kit - solid mass flywheel, replacement clutch cover & replacement clutch plate
DA6250G	Freelander 1 - 2.0 Td4	OEM dual mass flywheel conversion kit - solid mass flywheel, replacement clutch cover & replacement clutch plate
DA6251	Service kit for DA6250	Plate & cover



Diff Overhaul Kits

DA5035



DA5039 Front diff overhaul kit
4 bearings & 3 main oil seals
Discovery 3/ Discovery 4/
Range Rover Sport - 2005 - 2013

DA5035 Rear non-locking diff overhaul kit
6 bearings & 3 main oil seals
Discovery 3/ Discovery 4/
Range Rover Sport - 2005 - 2013

DA5038 Rear locking diff overhaul kit
5 bearings & 3 main oil seals
Discovery 3/ Discovery 4/
Range Rover Sport - 2005 - 2013

Diff Rebuild Kit



DA7211 Freelander 2
Rear diff rebuild kit
Customers may report excessive noise, either humming, a rumble or high pitched whine coming from the rear diff. This OEM kit will repair the pinion tail bearing which may cause the noise.

Rear Diff & Carrier

DA1216HD



DA1216HD NEW Freelander 2
Re-manufactured diff with heavy-duty input nose bearing.
DA1241 Range Rover Evoque - EH000001 onwards
Dynamic Driveline rear diff carrier to replace LR052118

Transfer Boxes

LR052756



IAB500104E Defender - Prefix 57D Td5 from 3A
LR052756 Defender - 2007 onwards



Chassis - Complete Galvanised Frames

Defender			
DA2056-M	Defender 90	Nat. asp./2.5 Td/200Tdi	Marsland chassis
DA2056-300TDI-M	Defender 90	300Tdi	Marsland chassis
DA2056-300TDI NEW	Defender 90	300Tdi	Richards chassis
KVD500710-M	Defender 90	Td5	Marsland chassis
DA2057*	Defender 110	Nat. asp./2.5 Td/200Tdi	Marsland chassis
DA2057-300TDI*	Defender 110	300Tdi	Marsland chassis
KVD500730	Defender 110	Td5	Richards chassis

DA5300 Defender 90/110
Bolt on crossmember - galvanised with fittings
*suitable for pick-up and station wagons

Discovery			
DA8900	Discovery 2 - Td5 - RHD	Up to 3A	Richards chassis
Series			
NRC4642G	Series SWB		Richards chassis
NRC4356	Series LWB		Richards chassis

Marsland Chassis

Chassis have bolt on gear box crossmember as standard with anti-roll bar brackets front and rear. The main legs are in pressed pieces as original made from 2mm steel with 3mm stiffeners fitted and spotwelded internally for added strength where outriggers and suspension mounting points are fitted, effectively giving you 5mm of material where most needed. Bolt on rail for rear tub mountings and LH & RH steering damper bracket welded on as standard. All tapped holes re-drilled and tapped, excess galv removed with riv nuts fitted for front & rear mud flaps, power steering pipe clips and step. Rear suspension upper link bush (A-frame) fitted with new M16 bolt and sleeve to fit old level bush.

DA2056-300TDI-M

More pictures online at
www.britpart.com/chassis

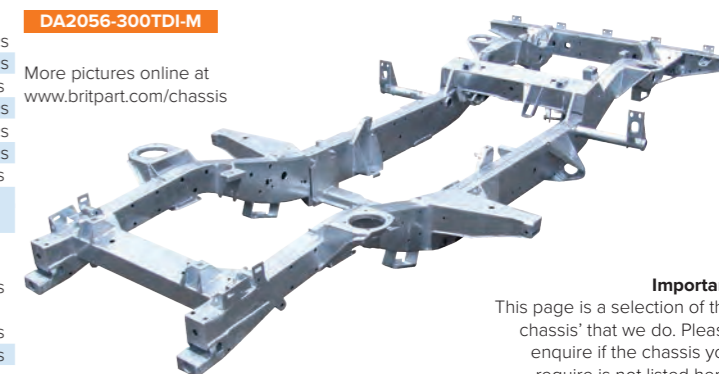

Important
This page is a selection of the chassis' that we do. Please enquire if the chassis you require is not listed here.

Richards Chassis

All Richards chassis are manufactured in the UK, using locally sourced materials and locally based machine shops. They are located close to the steel city, Sheffield, and therefore optimise the use of local steel, ensuring that all their chassis are formed from 2.5mm British steel which are all galvanised as standard. All profiling is done 'in house' using their own laser machine, enabling them to have greater control over the quality of parts used and the materials that they are formed from. The chassis are made using 2.5mm side rails which are 25% heavier than the standard 2.0mm rails. Overall this gives a small increase in the vehicle weight but has a massive effect on the long term durability of the chassis. Bolt on crossmembers are not supplied with Richards chassis but are available separately - see DA5300 above.



Photo courtesy of Andy Yung

Galvanised Products

DA5681 	DPB000270GALV 	RTC4769 	DA1188
DA1187 	DA1186 	NRC6372GALV 	DA1215
DA1233 	NRC9700GALV 	NRC4171GALV 	



Your complete Land Rover diagnostics tool!

Full details in the Diagnostics section

DA5681	Heavy-duty steel winch bumper	Defender - non air-con	Suitable for DB12000i, DB9500i, DB9000C & DB8000 winches
DPB000270GALV	Military front bumper	Defender	
RTC4769	Front bumperette - single	Defender/Series	
DA1188	Front mud flap brackets - pair	Defender 90/110	Equivalent to MTC3000 & MTC3001
DA1187	Rear mud flap brackets - pair	Defender 90	Equivalent to MUC3986 & MUC3987
DA1186	Standard height front shock turrets with fitting kit	Defender/Discovery 1/Range Rover Classic	
NRC6372GALV NEW	Standard height front shock turret	Defender/Discovery 1/Range Rover Classic	
DA1215	Rear spring seat fitting kit	Defender - 90/Discovery 1/Range Rover Classic	
DA1233	Rear spring seat fitting kit	Defender - 110/130	
NRC9700GALV NEW	Spring seat - single	Defender/Discovery 1/Range Rover Classic	
NRC4171GALV	Bolt-on centre crossmember	Defender Station wagon & crew cab	

Defender - Chassis & Body Components

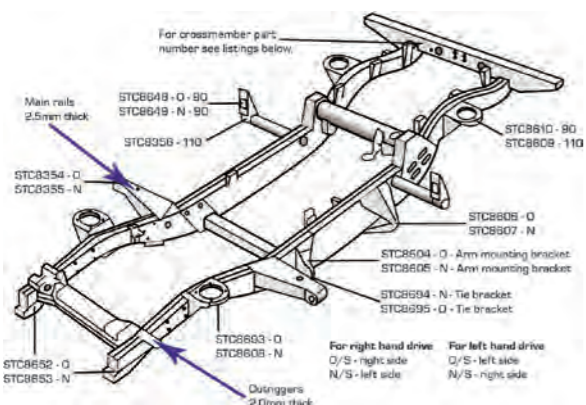

For many more body & chassis product pictures go to www.britpart.com/chassis



Bodywork - Bulkhead

DA4065O	90/110	Bulkhead upper repair panel	RHS
DA4065N	90/110	Bulkhead upper repair panel	LHS
DA4597O NEW	90/110	Bulkhead repair panel with vents	RHS
DA4597N NEW	90/110	Bulkhead repair panel with vents	LHS
DA4680 NEW	90/110	Extended bulkhead upper repair panels	Pair

Bodywork - Seats

DA4682 NEW	90/110	Seat box end panel	RHS
DA4681 NEW	90/110	Seat box end panel	LHS

Bodywork - Doors

ALR6852	90/110	Rear door - less spare wheel carrier From MA939976 up to 1A622423	
BIC710260	90/110	Rear door - 1 piece	
CQB000140	90/110	Glass for BIC710250	
LR031526	90/110	Heated glass for BIC710250	
CVW500010	90/110	Glazing rubber for BIC710250	
DA2026O		Door pillar repair - bulkhead/bracket	RHS
DA2026N		Door pillar repair - bulkhead/bracket	LHS
DA2024	90/110	Safari rear door skin	
DA4143	90/110	Front door skin - push button handle	RHS
DA4144	90/110	Front door skin - push button handle	LHS
STC542	90/110	Front door assembly - lift handle	RHS
STC543	90/110	Front door assembly - lift handle	LHS
DA5130	110/130	2nd row door skins - up to 5A689036	RHS
DA5131	110/130	2nd row door skins - up to 5A689036	LHS
DA4142 NEW	110/130	2nd row door skins - up to 5A689036 - steel	LHS
RTC6247	90/110	Safari rear door - unglazed with spare wheel	
RTC6248	90/110	Safari rear door - glazed without spare wheel	
RTC6248NG	90/110	Safari rear door - unglazed without spare wheel	

Chassis - Axle

STC8604	90/110	Front radius arm mount	RHS
STC8605	90/110	Front radius arm mount	LHS
STC8606	90/110	Rear radius arm mount	RHS
STC8607	90/110	Rear radius arm mount	LHS

Chassis - Bulkhead

STC8354	90/110	Bulkhead outrigger	RHS
STC8355	90/110	Bulkhead outrigger	LHS
STC8695	90/110	Tie bracket from bulkhead rigger	RHS
STC8694	90/110	Tie bracket from bulkhead rigger	LHS

Chassis - Crossmembers

ANR2056	90/110	Rear crossmember no extensions - pre-Td5	
DA4019	90*	Rear crossmember plus extensions - pre-Td5	
DA4020	110*	Rear crossmember plus extensions - pre-Td5	
DA4373	90*	Rear crossmember plus extensions - Td5	
DA4374	110*	Rear crossmember plus extensions - Td5	
DA4373S	90	Rear crossmember with short extensions - Td5	
DA4374S	110	Rear crossmember with short extensions - Td5	
KVB500060	90/110	Bolt on crossmember	
DA5300	90/110	Bolt on crossmember - galvanised with fittings	

*With long extensions and body brackets - see website for pictures.

KVB500230 110 Crossmember assembly - 2nd row seats Defender - 2007 onwards - crew cab

KVB000290 90/110 Rear crossmember no extensions - 2A627496 onwards

NRC4171GALV 110 Station wagon & crew cab galvanised bolt-on centre crossmember

Bodywork - Windows

DA4032	90/110	Window kit - standard	Pair	Clear
DA4032GREY	90/110	Window kit - standard	Pair	Grey tinted
DA4033	90/110	Window kit - deluxe	Pair	Clear
DA4033GREEN	90/110	Window kit - deluxe	Pair	Green tinted
DA4033GREY	90/110	Window kit - deluxe	Pair	Grey tinted
DA4033BRONZE	90/110	Window kit - deluxe	Pair	Bronze tinted
DA4033CATCH		Replacement catch for deluxe window kit	Single	
DA4032-3SEAL		Replacement window seal for above part numbers. One seal per kit.		

Bodywork - Wings

ALR6122	90/110	Front outer wing panel	RHS
ALR6121	90/110	Front outer wing panel	LHS
ASB710260	90/110	Front outer wing panel	RHS
ASB710270	90/110	Front outer wing panel	LHS
ALR6678	90/110	Front outer wing panel	RHS
ALR6677	90/110	Front outer wing panel	LHS
RTC6351	90/110	Front outer wing panel	RHS
RTC6350	90/110	Front outer wing panel	LHS
RTC6352	90/110	Front outer wing panel	LHS
DA2523 NEW	90/110	Front nose panel	RHS
DA2522 NEW	90/110	Front nose panel	LHS
DA2524 NEW	90/110	Wing top panel	RHS
DA2525 NEW	90/110	Wing top panel	LHS

ABS plastic front outer wing panels

DA2397	90/110	Replacement for ALR6678, ASB710280 & RTC6351	RHS
DA2399	90/110	Replacement for ALR6122 & ASB710260	RHS
DA2396	90/110	Replacement for RTC6352, ALR6677 & ASB710290	LHS
DA2398	90/110	Replacement for RTC6350, ALR6121 & ASB710270	LHS

Chassis - General

DA4516	90/110	Rear tie bar mounting bracket - single	
STC8356	110	Rear outrigger	RHS/LHS
STC8648	90	Rear tubular outrigger	RHS
STC8649	90	Rear tubular outrigger	LHS
STC8652	90/110	Front chassis leg	RHS
STC8653	90/110	Front chassis leg	LHS

Chassis - Suspension Mounts

DA4509	90/110	Front axle spring mount - 40mm lift	RHS
DA4508	90/110	Front axle spring mount - 40mm lift	LHS
DA4514	90/110	Front axle spring mount - standard	RHS
DA4513	90/110	Front axle spring mount - standard	LHS
DA4515	90/110	Rear shock absorber bracket - pair	
DA4518	90/110	Rear axle spring mount - 40mm lift	
DA4527	90/110	Rear axle spring mount - standard	
STC8693	90/110	Front spring seat	RHS
STC8608	90/110	Front spring seat	LHS
STC8610	90	Rear spring seat	RHS/LHS
STC8609	110	Rear spring seat	RHS/LHS

Discovery 1 - Chassis & Body Components



Bodywork - Doors

ALR5822	Door outer skin - MA163103 onwards	Front	RHS
ALR5823	Door outer skin - MA163103 onwards	Front	LHS
ALR8576	Door outer skin - TA163104 onwards	Front	RHS
ALR8577	Door outer skin - TA163104 onwards	Front	LHS
ALR8572	Door outer skin - TA163104 onwards	Rear	RHS
ALR8573	Door outer skin - TA163104 onwards	Rear	LHS
MWC9084	Door outer skin - MA112622 onwards	Rear	RHS
MWC9085	Door outer skin - MA112622 onwards	Rear	LHS

Bodywork - Floor

ASR1186	Rear floor plate		
ASR1594	Floor panel		RHS
ASR1595	Floor panel		LHS

Bodywork - General

MWC4840	Wheel arch panel	5-door	RHS
MWC4841	Wheel arch panel	5-door	LHS
DA4008O	Battery carrier		RHS
DA4008N	Battery carrier		LHS
MWC6702	Bonnet assembly		

Bodywork - Sills

MWC9060	Inner sill	3/5-door	RHS
MWC9061	Inner sill	3/5-door	LHS
STC2814	Outer sill	3-door	RHS
STC2813	Outer sill	3-door	LHS
STC2816	Outer sill	5-door	RHS
STC2815	Outer sill	5-door	LHS

Bodywork - Wings

MWC6754	Wing - up to LA081991	Front	RHS
ALR6682	Wing - MA onwards	Front	RHS
ALR6681	Wing - MA onwards	Front	LHS
ALR9878	Wing - VA onwards	Front	RHS
ALR9877	Wing - VA onwards	Front	LHS
DA4586O	Inner wing repair section	Front	RHS
DA4586N	Inner wing repair section	Front	LHS

For many more body & chassis product pictures go to www.britpart.com/chassis

Chassis - Bulkhead

ALR6272	Bulkhead - MA081991 onwards		Front
---------	-----------------------------	--	-------

Chassis - Crossmembers

ALR8519	Front floor crossmember		
ALR8520	Rear crossmember		
ASR1187	Rear floor crossmember		
DA4530	Rear crossmember end repair panels for crossmember STC1066	Pair	
STC1066	Crossmember assembly rear floor		

Chassis - General

DA4516	Rear tie bar mounting bracket		Single
DA4519	Rear body mount		

Chassis - Suspension Mounts

DA4509	Front axle spring mount - 40mm lift		RHS
DA4508	Front axle spring mount - 40mm lift		LHS
DA4514	Front axle spring mount - standard		RHS
DA4513	Front axle spring mount - standard		LHS
DA4515	Rear shock absorber bracket		Pair
DA4518	Rear axle spring mount - 40mm lift		
DA4527	Rear axle spring mount - standard		

Discovery 2 - Chassis & Body Components



DA8902O	Rear chassis leg	RHS
DA8902N	Rear chassis leg	LHS
DA8903	Rear quarter chassis	

Range Rover Classic - Chassis & Body Components

Series 2 & 3 - Chassis & Body Components

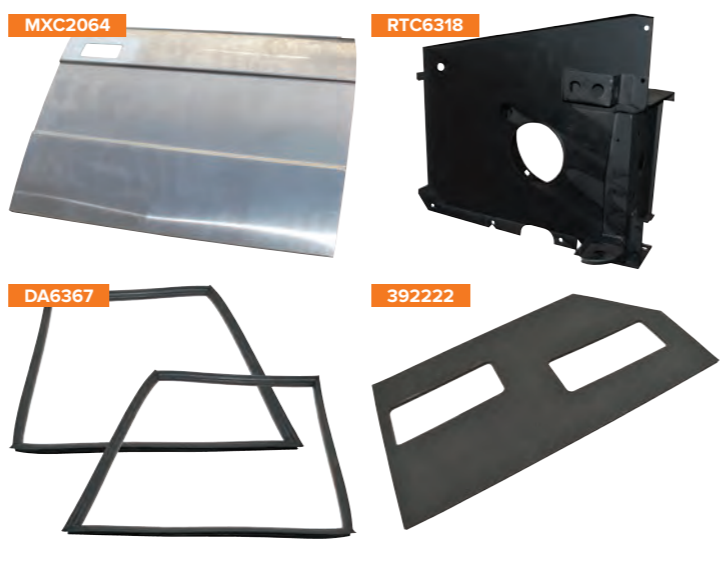
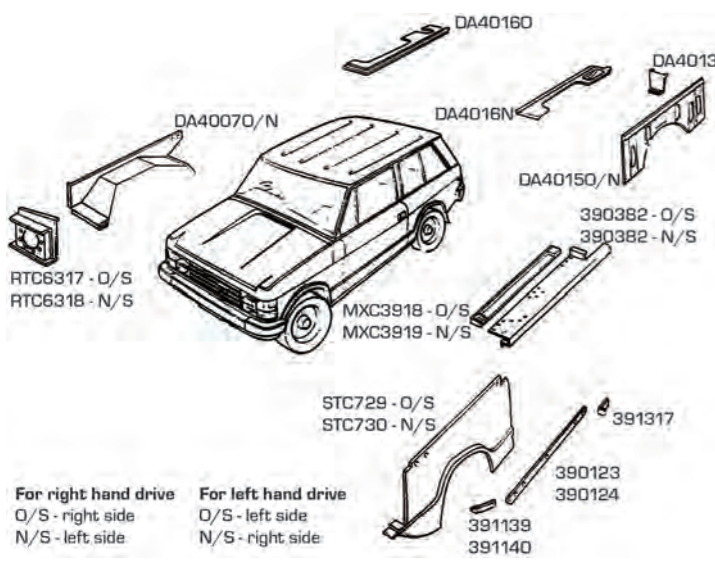

Bodywork - Doors

MXC2064	Door outer skin - front	4-door	RHS
MXC2063	Door outer skin - front	4-door	LHS

Bodywork - General

DA40130	Rear arch extension - rear		RHS
DA4013N	Rear arch extension - rear		LHS
RTC6204	Light panel - rear		LHS
RTC6317	Headlamp box		RHS
RTC6318	Headlamp box		LHS
DA40080	Battery carrier		RHS
DA4008N	Battery carrier		LHS
DA6367	Rear quarter window seal	4-door	Pair
DA6516 NEW	Rear window seal - 1970 - 1986	2-door	Pair
390055 NEW	Rear quarter panel fixing plate		Single
391127 NEW	Rear side window channel		Single
391141 NEW	Front wing seal		Single
391546 NEW	Side window gasket		Single
392222 NEW	Anti-rattle pad		Single
392223 NEW	Anti-rattle pad		Single
AEU1523 NEW	Rear lamp gasket		Single
AEU1525 NEW	Rear lamp gasket		Single
MRC7166 NEW	Lock & handle gasket		Single
MXC8335 NEW	Check strap seal		Single
PRC2949 NEW	Bonnet lamp rubber		Single
RTC4517CL NEW	Glazed tailgate - 1986 - 1991		Single

Bodywork - Sills

390381	Complete sill - outer, no mounts	2-door	RHS
390382	Complete sill - outer, no mounts	2-door	LHS
DA3016	Outer sills	2-door	RHS
DA3017	Outer sills	2-door	LHS
DA41200	Half sill (repair) - outer	4-door	RHS
DA4120N	Half sill (repair) - outer	4-door	LHS
MXC3918	Sill inner	2-door	RHS
MXC3919	Sill inner	2-door	LHS
STC1136	Outer sills	4-door	RHS
STC1135	Outer sills	4-door	LHS

Bodywork - Wings

DA40070	Inner wing		RHS
DA4007N	Inner wing		LHS
DA40160	Rear inner wing - floor section		RHS
DA4016N	Rear inner wing - floor section		LHS
DA40150	Rear inner wing - side panel		RHS
DA4015N	Rear inner wing - side panel		LHS

ABS plastic front outer wing panels

DA2468	Replacement for STC729 - up to 1988		RHS
DA2467	Replacement for STC730 - up to 1988		LHS
DA2469	Replacement for MXC1408 - 1989 onwards		RHS
DA2470	Replacement for MXC1409 - 1989 onwards		LHS

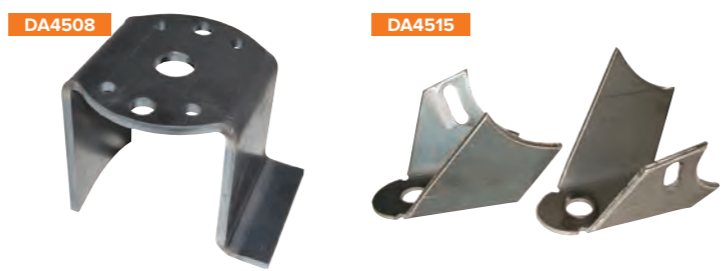

Chassis - Crossmembers

ALR8520	Rear crossmember - 1990 onwards		
NRC4717	Tailgate crossmember - rear		

Chassis - General

DA4516	Rear tie bar mounting bracket		Single
--------	-------------------------------	--	--------

Chassis - Suspension Mounts

DA4509	Front axle spring mount - 40mm lift		RHS
DA4508	Front axle spring mount - 40mm lift		LHS
DA4514	Front axle spring mount - standard		RHS
DA4513	Front axle spring mount - standard		LHS
DA4515	Rear shock absorber bracket		Pair
DA4518	Rear axle spring mount - 40mm lift		
DA4527	Rear axle spring mount - standard		

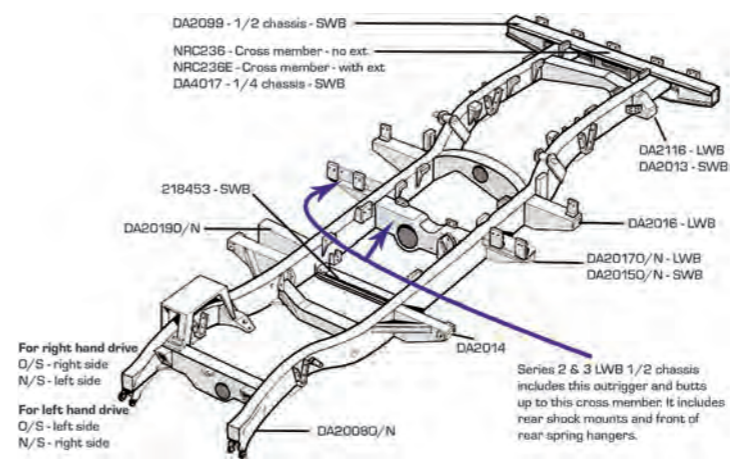

For many more body & chassis product pictures go to www.britpart.com/chassis

Bodywork - Bulkhead

DA40650	SWB/LWB	Bulkhead upper repair panel	RHS
DA4065N	SWB/LWB	Bulkhead upper repair panel	LHS
DA45970 NEW	SWB/LWB	Bulkhead repair panel with vents	RHS
DA4597N NEW	SWB/LWB	Bulkhead repair panel with vents	LHS
DA4680 NEW	SWB/LWB	Extended bulkhead upper repair panels	Pair

Bodywork - Seats

DA4682 NEW	SWB/LWB	Seat box end panel	RHS
DA4681 NEW	SWB/LWB	Seat box end panel	LHS

Bodywork - Sills

330326 NEW	SWB	Front sill panel - 5"	RHS
330327 NEW	SWB	Front sill panel - 5"	LHS
330336 NEW	SWB	Rear sill panel - 5"	RHS
330337 NEW	SWB	Rear sill panel - 5"	LHS

Bodywork - Doors

306460 NEW	SWB/LWB	Interior handle	
395529	SWB/LWB	Door bottom	RHS
395530	SWB/LWB	Door bottom	LHS
DA2007	SWB/LWB	Door rubber	30m roll
DA2024	SWB/LWB	Safari rear door - skin	
RTC6247	SWB/LWB	Safari rear door - unglazed with spare wheel	
RTC6248	SWB/LWB	Safari rear door - glazed without spare wheel	
RTC6248NG	SWB/LWB	Safari rear door - unglazed without spare wheel	
DA20260		Door pillar repair - bulkhead/bracket	RHS
DA2026N		Door pillar repair - bulkhead/bracket	LHS
DA4054		Bracket for DA2026N/DA2026O - pair	RHS/LHS
DA20230	SWB/LWB	Door skin	RHS
DA2023N	SWB/LWB	Door skin	LHS
MTC5382	SWB/LWB	Door top - unglazed	RHS
MTC5383	SWB/LWB	Door top - unglazed	LHS
MTC5382G	SWB/LWB	Door top - glazed	RHS
MTC5383G	SWB/LWB	Door top - glazed	LHS
DA4086	SWB/LWB	Rear & side door bottom repair section	
DA2156	SWB/LWB	Glazing kit - door top	Series 3
DA1070	SWB/LWB	Front door hinge kit - torx head bolts kit	
DA1131	SWB/LWB	Front door hinge kit - aluminium hinges	

Bodywork - Footwells

DA20010	SWB/LWB	Footwell	RHD	RHS
DA2001N	SWB/LWB	Footwell	RHD	LHS
DA4018N	SWB/LWB	Footwell	LHD	RHS
DA40180	SWB/LWB	Footwell	LHD	LHS

Bodywork - Windows

DA2002	SWB/LWB	Window channel	2m length	
DA4032	SWB/LWB	Window kit - standard	Pair	Clear
DA4032GREY	SWB/LWB	Window kit - standard	Pair	Grey tinted
DA4033	SWB/LWB	Window kit - deluxe	Pair	Clear
DA4033GREEN	SWB/LWB	Window kit - deluxe	Pair	Green tinted
DA4033GREY	SWB/LWB	Window kit - deluxe	Pair	Grey tinted
DA4033BRONZE	SWB/LWB	Window kit - deluxe	Pair	Bronze tinted
DA4033CATCH		Replacement catch for deluxe window kit		Single
DA4032-3SEAL		Replacement window seal for above part numbers. One seal per kit.		

Bodywork - Front

DA2521 NEW	Series 3	Nose panel		RHS
DA2520 NEW	Series 3	Nose panel		LHS

Bodywork - Wings

Aluminium front outer wing panels

330426	Series 2 & 2A - right & left hand drive		RHS with no hole	
330427	Series 2 & 2A - right & left hand drive		LHS with no hole	
347474 NEW	Series 3 - left hand drive		RHS with hole	
STC8295 NEW	Series 3 - right hand drive		LHS with hole	

ABS plastic front outer wing panels

DA2463	Series 2 & 2A - right & left hand drive		RHS with no hole	
	Series 3 - right hand drive			
DA2462	Series 2 & 2A - right & left hand drive		LHS with no hole	
	Series 3 - left hand drive			
DA2464	Series 3 - right hand drive		LHS with hole	
DA2465	Series 3 - left hand drive		RHS with hole	

Bodywork - Other

DA6110 NEW	Series 1/Series 2/Series 2A	Headlamp surround		
------------	-----------------------------	-------------------	--	--



Chassis - Crossmembers

218453	SWB	Gearbox crossmember - weld on		
559822	Military	Rear crossmember		
DA4017	SWB	Rear crossmember / 1/4 chassis with extensions and hangers		
NRC236	SWB/LWB	Rear crossmember - no extensions		
NRC236E	SWB/LWB	Rear crossmember - with extensions, no hangers		

Chassis - General

DA20080	SWB/LWB	Chassis leg - front		RHS
DA2008N	SWB/LWB	Chassis leg - front		LHS
DA2009	SWB/LWB	Extension piece (2 x 'U' shape sections) for rear crossmember		
DA2014	SWB/LWB	Bulkhead outrigger		
DA20150	SWB	Rear tank outrigger		RHS
DA2015N	SWB	Rear tank outrigger		LHS
DA20170	LWB	Rear tank outrigger		RHS
DA2017N	LWB	Rear tank outrigger		LHS
DA20190	SWB	Front tank outrigger		RHS
DA2019N	SWB	Front tank outrigger		LHS
DA2099	SWB	1/2 Chassis		

Chassis - Suspension Mounts

DA2013	SWB	Spring hanger		
DA2016	LWB	Spring hanger - front		
DA2116	LWB	Spring hanger - rear		

Other - Chassis & Body Components



Freelander 1
ALR8710 Bulkhead front assembly

Freelander 2
DA5671 Bumper
With headlamp power wash, front parking aid & front fog lamps.

Discovery 3
DA5672 Bumper
With headlamp power wash & front parking aid

Door Hinge Kits



DA1131 Defender/Series 3 Front doors with natural finish aluminium door hinges and stainless steel hinge pins. 4 hinges per set complete with fixings.

DA1309 NEW Defender/Series 3 2nd row doors with natural finish aluminium door hinges and stainless steel hinge pins. 4 hinges per set complete with fixings.

DA1305 NEW Defender/Series 3 Front doors with anodised black aluminium door hinges and stainless steel hinge pins. 4 hinges per set complete with fixings.

DA1306 NEW Defender/Series 3 2nd row doors with anodised black aluminium door hinges and stainless steel hinge pins. 4 hinges per set complete with fixings.

DA1070 Defender/Series 3 Front door hinge kit with torx head bolts and all other fixings. Defender - 2007 onwards but can be used on earlier vehicles.

DA1070SS NEW Defender/Series 3 Front door hinge kit with stainless steel torx head bolts and all other fixings. Defender - 2007 onwards but can be used on earlier vehicles.

DA1275 NEW Defender/Series 3 2nd row door hinge kit with torx head bolts and all other fixings. Defender - 2007 onwards but can be used on earlier vehicles.

DA1275SS NEW Defender/Series 3 2nd row door hinge kit with stainless steel torx head bolts and all other fixings. Defender - 2007 onwards but can be used on earlier vehicles.

DA1240 Defender Rear end door hinge kit. Supplied with stainless steel fitting kit.

DA1240SS NEW Defender Rear end door hinge kit. Supplied with stainless steel torx head. Defender - 2007 onwards but can be used on earlier vehicles.

Fuel Latch Repair Kit



DA1114
Discovery 3/Discovery 4
Range Rover Sport - 2015 - 2013
This handy little OEM kit is used to repair the temperamental fuel latch.

Door Lock NEW



DA8957 NEW
Defender - 2007 onwards
Front door
Barrel & keys

Tailgate Half Door Kit NEW



DA6520 NEW
Defender
Converts a vehicle with a drop down tailgate to a side opening half door. Ideal for pick-ups and soft-tops.



Window Kits



DA4032GREY

DA4033GREY

DA4033GREEN



DA4033

Deluxe - Defender & Series
Deluxe kits have rubber mounting strips to cover rivets and a plastic catch. Glass is toughened to E11 CE R - 43.

DA4033	Clear	Pair
DA4033GREEN	Green tinted	Pair
DA4033GREY	Grey tinted	Pair
DA4033BRONZE	Bronze tinted	Pair

DA4032-3SEAL
Replacement window seal for both standard and deluxe windows. Each kit does one window.

DA4033CATCH
Replacement catch for deluxe window kit. Single.

Standard - Defender & Series
Standard kits have a metal catch. Glass is toughened to E11 CE R - 43.

DA4032	Clear	Pair
DA4032GREY	Grey tinted	Pair



Photo courtesy of Nuwan de Silva



Photo courtesy of Sohini Adhikary



Britpart Service Kits
Quality service parts manufactured to O.E. specification and competitively priced.

“Servicing a Land Rover just got a whole lot easier with Britpart!”

Ever started servicing a Land Rover and then suddenly realised you haven't ordered a filter for forgot the sump plug washers?

Well now thanks to Britpart with one simple part number you can order your Land Rover kit safe in the knowledge that all the parts you need will be there for you to complete the job. No more half-finished services!



Alternative Brand Service Kits
Britpart stock a wide range of alternative brand service kits with OEM brands including Coopers, Mann, Mahle, Champion & NGK.



Pictures for illustrative purposes only

www.britpart.com/servicekits

Land Rover Service Kits
A wide range of service kits using genuine filters and spark/heater plugs.

Note
Blue part numbers
Britpart filters & spark/heater plugs
Red part numbers ending in 'P'
OEM filters & spark/heater plugs
Green part numbers ending in 'LR'
Genuine filters & spark/heater plugs

Defender

DA6000 Defender - 2½ petrol 7:1 compression ratio 1 x ERR3340 Oil filter 1 x NRC9238 Air filter 1 x JS660L Fuel filter 1 x 243959 Sump plug washer 1 x FRC4808 Sump plug washer 4 x RTC3571 Spark plugs	DA6003 Defender - 300Tdi 1 x ERR3340 Oil filter 1 x ESR2623 Air filter 1 x AEU2147L Fuel filter 1 x UAM2857L Sump plug washer 1 x ALU1403L Sump plug washer	DA6003P Oil filter Air filter Fuel filter Sump plug washer Sump plug washer
DA6001 Defender - Turbo D 1 x ERR3340 Oil filter 1 x NRC9238 Air filter 1 x RTC6079 Fuel filter 1 x FRC4808 Sump plug washer	DA6004 Defender - Td5 1 x LPX100590 Oil filter 1 x ESR4238 Air filter 1 x ERR6299 Rotor filter 1 x ESR4686 Fuel filter 1 x CDU1001L Sump plug washer	DA6004P Oil filter Air filter Rotor filter Fuel filter Sump plug washer
DA6002 Defender - 200Tdi 1 x ERR3340 Oil filter 1 x NTC6660 Air filter 1 x AEU2147L Fuel filter 1 x 213961L Sump plug washer 1 x ETC7398 Sump plug washer	DA6004XD Defender - Td5 1 x LPX100590XD Oil filter Shorter than the standard filter which makes this one easier to fit and remove. 1 x ESR4238 Air filter 1 x ERR6299 Rotor filter 1 x ESR4686 Fuel filter 1 x CDU1001L Sump plug washer	DA6004LR Oil filter Air filter Rotor filter Fuel filter Sump plug washer

Series

DA6040 Defender - 2007 onwards 2.4 & 2.2 - up to DA444246 1 x LR004459 Oil filter 1 x WJI500040 Fuel filter 1 x PHE500060 Air filter 1 x 1013938 Oil drain plug inc. rubber seal	DA6040P Oil filter Fuel filter Air filter Oil drain plug inc. rubber seal	DA6040LR Oil filter Fuel filter Air filter Oil drain plug inc. rubber seal
DA6109 Defender - 2007 onwards 2.2 - DA444247 onwards 1 x LR058104 Oil filter 1 x WJI500040 Fuel filter 1 x PHE500060 Air filter 1 x 1013938 Oil drain plug inc. rubber seal	DA6109P Oil filter Fuel filter Air filter Oil drain plug inc. rubber seal	DA6109LR Oil filter Fuel filter Air filter Oil drain plug inc. rubber seal
DA6032 Series 2¼ petrol - 1964 onwards Lucas ignition (fixed points) 1 x RTC3184 Oil filter 1 x 606168 Fuel filter (in-line) 4 x RTC3570 Spark plugs 1 x RTC3270 Points (fixed) 1 x RTC3472 Condenser 1 x 243959 Sump plug washer	DA6033 Series 2¼ petrol - 1964 onwards Lucas ignition (sliding points) 1 x RTC3184 Oil filter 1 x 606168 Fuel filter (in-line) 4 x RTC3570 Spark plugs 1 x RTC364 Points (sliding) 1 x RTC3288 Points (sliding) 1 x RTC6621 Condenser 1 x 243959 Sump plug washer	DA6034 Series 2¼ petrol - 1964 onwards (Ducellier ignition) 1 x RTC3184 Oil filter 1 x 606168 Fuel filter (in-line) 4 x RTC3570 Spark plugs 1 x RTC6625 Points 1 x RTC6620 Condenser 1 x 243959 Sump plug washer

Discovery

Discovery 1

DA6005	DA6005P	
Discovery 1 - 200Tdi - up to JA018272		
1 x ERR3340	Oil filter	
1 x NTC1435	Air filter	
1 x AEU2147L	Fuel filter	
1 x 213961L	Sump plug washer	
DA6006	DA6006P	
Discovery 1 - 200Tdi - JA018273 onwards		
1 x ERR3340	Oil filter	
1 x ESR1049	Air filter	
1 x AEU2147L	Fuel filter	
1 x 213961L	Sump plug washer	
DA6007	DA6007P	
Discovery 1 - 300Tdi		
1 x ERR3340	Oil filter	
1 x ESR1445	Air filter	
1 x AEU2147L	Fuel filter	
1 x UAM2857L	Sump plug washer	
1 x ALU1403L	Sump plug washer	
DA6008		
Discovery 1 - 3.5 Efi		
1 x ERR3340	Oil filter	
1 x RTC4683	Air filter	
8 x ERR3799	Spark plugs	
1 x ESR4065	Fuel filter (in-line)	
1 x 213961L	Sump plug washer	
DA6009		
Discovery 1 - 3.9 Efi		
1 x ERR3340	Oil filter	
1 x ESR1445	Air filter	
1 x ESR4065	Fuel filter	
1 x ETC7398	Sump plug washer	

Discovery 2

DA6004	DA6004P	DA6004LR
Discovery 2 - Td5		
1 x LPX100590	Oil filter	
1 x ESR4238	Air filter	
1 x ERR6299	Rotor filter	
1 x ESR4686	Fuel filter	
1 x CDU1001L	Sump plug washer	
DA6004XD NEW		
Discovery 2 - Td5		
1 x LPX100590XD	Oil filter	
Shorter than the standard filter which makes this one easier to fit and remove.		
1 x ESR4238	Air filter	
1 x ERR6299	Rotor filter	
1 x ESR4686	Fuel filter	
1 x CDU1001L	Sump plug washer	
DA6010	DA6010P	DA6010LR
Discovery 2 - V8 4.0		
1 x ERR3340	Oil filter	
1 x ESR4238	Air filter	
8 x NLP100320	Spark plugs	
1 x ALU1403L	Sump plug washer	

"All the parts you need will be there for you to complete the job"

Discovery 3

DA6035	DA6035P	DA6035LR
Discovery 3 - 2.7 diesel - up to 6A999999		
1 x 1311289	Oil filter	
1 x PHE000112	Air filter	
1 x LR010075	Fuel filter	
1 x JKR500020	Cabin filter	
1 x 1013938	Oil drain plug inc. rubber seal	
DA6041	DA6041P	DA6041LR
Discovery 3 - 2.7 diesel - 7A onwards		
1 x 1311289	Oil filter	
1 x PHE000112	Air filter	
1 x JKR500020	Cabin filter	
1 x LR009705	Fuel filter	
1 x 1013938	Oil drain plug inc. rubber seal	
DA6037	DA6037P	DA6037LR
Discovery 3 - 4.4 petrol		
1 x LR007160	Oil filter	
1 x PHE000112	Air filter	
8 x LR005253	Spark plugs	
1 x JKR500020	Cabin filter	
1 x 1013938	Oil drain plug inc. rubber seal	
DA6087	DA6087P	DA6087LR
Discovery 3 - 4.0 V6 petrol		
1 x 4454116	Oil filter	
(vehicles with engine oil cooler)		
1 x PHE000112	Air filter	
1 x JKR500020	Cabin filter	
6 x LR000604	Spark plugs	
1 x 1013938	Oil drain plug inc. rubber seal	

Discovery 4

DA6041	DA6041P	DA6041LR
Discovery 4 - 2.7 diesel		
1 x 1311289	Oil filter	
1 x PHE000112	Air filter	
1 x JKR500020	Cabin filter	
1 x LR009705	Fuel filter	
1 x 1013938	Oil drain plug inc. rubber seal	
DA6086	DA6086P	DA6086LR
Discovery 4 - 3.0 V6 diesel		
1 x LR013148	Oil filter	
1 x PHE000112	Air filter	
1 x JKR500020	Cabin filter	
1 x LR009705	Fuel filter	
1 x 1013938	Oil drain plug inc. rubber seal	
DA6087	DA6087P	DA6087LR
Discovery 4 - 4.0 V6 petrol		
1 x 4454116	Oil filter	
(vehicles with engine oil cooler)		
1 x PHE000112	Air filter	
1 x JKR500020	Cabin filter	
6 x LR000604	Spark plugs	
1 x 1013938	Oil drain plug inc. rubber seal	
DA6088	DA6088P	DA6088LR
Discovery 4 - 5.0 V8 petrol		
1 x LR011279	Oil filter	
2 x LR011593	Air filters	
1 x JKR500020	Cabin filter	
8 x LR032080	Spark plugs	
1 x 4594914	Oil drain plug	

Discovery Sport NEW

DA6089	DA6089P	DA6089LR
NEW Discovery Sport - 2.0 petrol		
1 x LR025306	Oil filter	
1 x LR029078	Air filter	
1 x LR056138	Cabin filter	
4 x LR025605	Spark plugs	
1 x LR025048	Oil drain plug	
DA6091	DA6091P	DA6091LR
NEW Discovery Sport - 2.2 diesel		
1 x LR001247	Oil filter	
1 x LR029078	Air filter	
1 x LR056138	Cabin filter	
1 x LR001313	Fuel filter	
1 x LR004304	Oil drain plug	
1 x LR006295	Oil drain plug seal	



Photo courtesy of Pamela Blair

Freelander

www.britpart.com/servicekits

Freelander 1

DA6011		
Freelander 1 - 1.8 petrol - up to YA999999		
1 x CDU1268	Oil filter	
1 x ESR4103	Air filter	
1 x JKR100200	Pollen filter	
1 x ALU1403L	Sump plug washer	
4 x NLP100290L	Spark plugs	
DA6012		
Freelander 1		
1.8 petrol - 1A000001 onwards		
1 x CDU1268	Oil filter	
1 x ESR4103	Air filter	
1 x JKR100280	Pollen filter	
1 x ALU1403L	Sump plug washer	
DA6013	DA6013P	
Freelander 1 - 2.0 diesel TCIE		
1 x ERR5542	Oil filter	
1 x ESR4103	Air filter	
1 x WJN10046	Fuel filter	
1 x JKR100200	Pollen filter	
1 x ALU1403L	Sump plug washer	
DA6014	DA6014P	DA6014LR
Freelander 1 - Td4 - up to 2A209830		
1 x LRF100150L	Oil filter	
1 x PHE100500L	Air filter	
1 x JKR100280	Pollen filter	
1 x ALU1403L	Sump plug washer	
1 x MUN000010	Fuel filter	
DA6015	DA6015P	DA6015LR
Freelander 1 - Td4 - 2A209831 onwards		
1 x LRF100150L	Oil filter	
1 x PHE100500L	Air filter	
1 x JKR100280	Pollen filter	
1 x ALU1403L	Sump plug washer	
1 x WJN000080	Fuel filter	

Freelander 2

DA6038	DA6038P	DA6038LR
Freelander 2 - 2.2 diesel		
1 x LR001247	Oil filter	
1 x LR005816	Air filter	
1 x LR001313	Fuel filter	
1 x LR056138	Cabin filter	
1 x LR006295	Drain plug gasket	
DA6039	DA6039P	DA6039LR
Freelander 2 - 3.2 petrol		
1 x LR001419	Oil filter	
1 x LR005816	Air filter	
6 x LR005483	Spark plugs	
1 x LR056138	Cabin filter	
1 x LR000506	Drain plug gasket	
DA6089	DA6089P	DA6089LR
NEW Freelander 2 - 2.0 petrol		
1 x LR025306	Oil filter	
1 x LR029078	Air filter	
1 x LR056138	Cabin filter	
4 x LR025605	Spark plugs	
1 x LR025048	Oil drain plug	

"No more half finished services"



Photo courtesy of Sean Lannan

Range Rover

Range Rover Classic

DA6016		
Range Rover Classic - 3.5 - 1970 - 1975		
1 x RTC3186	Oil filter	
2 x 605191	Air filters	
1 x JS660L	Fuel filter	
8 x RTC3573	Spark plugs	
1 x 213961L	Sump plug washer	
2 x 603330	Flame traps	
1 x RTC6623	Points (fixed)	
1 x RTC3472	Condenser	
DA6017		
Range Rover Classic - 3.5 - 1975 - 1982		
1 x ERR3340	Oil filter	
2 x 605191	Air filters	
1 x JS660L	Fuel filter	
8 x RTC3573	Spark plugs	
1 x 213961L	Sump plug washer	
2 x 603330	Flame traps	
1 x RTC6623	Points (fixed)	
1 x RTC3472	Condenser	
DA6018		
Range Rover Classic - 3.5 - 1982 - 1983		
1 x ERR3340	Oil filter	
2 x 605191	Air filters	
1 x JS660L	Fuel filter	
8 x RTC3570	Spark plugs	
1 x 213961L	Sump plug washer	
2 x 603330	Flame traps	
DA6019		
Range Rover Classic - 3.5 - 1984 - 1986		
1 x ERR3340	Oil filter	
2 x 605191	Air filters	
1 x JS660L	Fuel filter	
8 x RTC3570	Spark plugs	
1 x 213961L	Sump plug washer	
2 x 603330	Flame traps	
DA6020		
Range Rover Classic - 3.5 carb - 1986 - 1991		
1 x ERR3340	Oil filter	
2 x 605191	Air filters	
1 x JS660L	Fuel filter	
8 x RTC3812	Spark plugs	
1 x 213961L	Sump plug washer	
2 x 603330	Flame traps	

DA6021		
Range Rover Classic - 3.5/3.9 Efi 1986 - 1991 up to GA464553		
1 x ERR3340	Oil filter	
1 x RTC4683	Air filter	
1 x ESR4065	Fuel filter	
1 x NTC5958	Fuel filter	
1 x 213961L	Sump plug washer	
DA6022		
Range Rover Classic - 3.9 Efi 1986 - 1994 from HA464554 up to LA647644		
1 x ERR3340	Oil filter	
1 x RTC4683	Air filter	
1 x ESR4065	Fuel filter	
1 x 213961L	Sump plug washer	
DA6023		
Range Rover Classic - 3.9 Efi 1992 - 1994 - MA647645 onwards		
1 x ERR3340	Oil filter	
1 x ESR1445	Air filter	
1 x ESR4065	Fuel filter	
8 x ERR3799	Spark plugs	
1 x 213961L	Sump plug washer	
DA6024		
Range Rover Classic - 4.2 - 1992 - 1994		
1 x ERR3340	Oil filter	
1 x ESR1445	Air filter	
1 x ESR4065	Fuel filter	
8 x ERR3799	Spark plugs	
1 x 213961L	Sump plug washer	
DA6006	DA6006P	
Range Rover Classic - 200Tdi		
1 x ERR3340	Oil filter	
1 x ESR1049	Air filter	
1 x AEU2147L	Fuel filter	
1 x 213961L	Sump plug washer	
DA6007	DA6007P	
Range Rover Classic - 300Tdi		
1 x ERR3340	Oil filter	
1 x ESR1445	Air filter	
1 x AEU2147L	Fuel filter	
1 x UAM2857L	Sump plug washer	
1 x ALU1403L	Sump plug washer	

Range Rover P38

DA6025		
Range Rover P38 - 4.0/4.6 up to TA346793 & from WA376580 up to WA385948		
1 x ERR3340	Oil filter	
1 x ESR341	Air filter	
1 x ESR4065	Fuel filter	
8 x ERR3799	Spark plugs	
2 x BTR8037	Pollen filters	
1 x UAM2857L	Sump plug washer	
1 x ALU1403L	Sump plug washer	
DA6026		
Range Rover P38 - 4.0/4.6 from VA346794 up to VA376579 & from WA385949 onwards		
1 x ERR3340	Oil filter	
1 x ESR4238	Air filter	
1 x ESR4065	Fuel filter	
8 x ERR3799	Spark plugs	
2 x BTR8037	Pollen filters	
1 x UAM2857L	Sump plug washer	
1 x ALU1403L	Sump plug washer	
DA6027	DA6027P	
Range Rover P38 - 2.5 DT to engine no. 33978348 up to (Dec 1995) type A oil filter		
1 x STC2180	Oil filter type A	
1 x ESR341	Air filter	
1 x STC2827	Fuel filter	
2 x BTR8037	Pollen filters	
1 x VYX000040	Sump plug washer	
DA6028	DA6028P	
Range Rover P38 - 2.5 DT from engine no. 33988348 from (Dec 1995) up to TA346793 type B oil filter		
1 x STC3350	Oil filter type B	
1 x ESR341	Air filter	
1 x STC2827	Fuel filter	
2 x BTR8037	Pollen filters	
1 x VYX000040	Sump plug washer	
DA6029	DA6029P	
Range Rover P38 - 2.5 DT from engine no. 33988348 from (Dec 1995) from TA346794 type B oil filter		
1 x STC3350	Oil filter type B	
1 x ESR4238	Air filter	

Range Rover - continued

Brake Cleaner

Range Rover L405

- DA6095 Range Rover - 3.0 V6 diesel
 - 1 x LR013148 Oil filter
 - 2 x LR011593 Air filter
 - 1 x LR041978 Fuel filter
 - 1 x LR036369 Cabin filter
 - Oil drain plug
 - 1 x 1013938 inc. rubber seal

- DA6096P Range Rover - 4.4 V8 diesel
 - 1 x LR022896 Oil filter
 - 2 x LR011593 Air filter
 - 1 x LR029098 Fuel filter
 - 1 x LR036369 Cabin filter
 - Oil drain plug
 - 1 x 4594914 inc. rubber seal

- DA6097 Range Rover - 3.0 V6 petrol - up to EA128397
 - 1 x LR011279 Oil filter
 - 2 x LR011593 Air filter
 - 1 x LR036369 Cabin filter
 - 6 x LR041664 Spark plugs
 - Oil drain plug
 - 1 x 4594914 inc. rubber seal

- DA6098 Range Rover - 3.0 V6 petrol - EA128398 onwards
 - 1 x LR011279 Oil filter
 - 2 x LR011593 Air filter
 - 1 x LR036369 Cabin filter
 - 6 x LR050998 Spark plugs
 - Oil drain plug
 - 1 x 4594914 inc. rubber seal

- DA6099 Range Rover - 5.0 V8 petrol naturally aspirated & supercharged - 2014 MY
 - 1 x LR011279 Oil filter
 - 2 x LR011593 Air filter
 - 1 x LR036369 Cabin filter
 - 8 x LR032080 Spark plugs
 - Oil drain plug
 - 1 x 4594914 inc. rubber seal

Range Rover Sport

- DA6035 Range Rover Sport - 2.7 diesel up to 6A999999
 - 1 x 1311289 Oil filter
 - 1 x PHE000112 Air filter
 - 1 x LR010075 Fuel filter
 - 1 x JKR500020 Cabin filter
 - Oil drain plug
 - 1 x 1013938 inc. rubber seal

- DA6048 Range Rover Sport - 2.7 diesel from 7A000001
 - 1 x 1311289 Oil filter
 - 1 x PHE000112 Air filter
 - 1 x LR009705 Fuel filter
 - 1 x JKR500020 Cabin filter
 - Oil drain plug
 - 1 x 1013938 inc. rubber seal

- DA6036 Range Rover Sport - 3.6 diesel
 - 1 x LR002338 Oil filter
 - 1 x PHE000112 Air filter
 - 1 x LR009705 Fuel filter
 - 1 x JKR500020 Cabin filter
 - Oil drain plug
 - 1 x 1013938 inc. rubber seal

- DA6037 Range Rover Sport - 4.2/4.4 petrol
 - 1 x LR007160 Oil filter
 - 1 x PHE000112 Air filter
 - 8 x LR005253 Spark plugs
 - 1 x JKR500020 Cabin filter
 - Oil drain plug
 - 1 x 1013938 inc. rubber seal

- DA6086 Range Rover Sport - 3.0 V6 diesel
 - 1 x LR013148 Oil filter
 - 1 x PHE000112 Air filter
 - 1 x JKR500020 Cabin filter
 - 1 x LR009705 Fuel filter
 - Oil drain plug
 - 1 x 1013938 inc. rubber seal

- DA6088 Range Rover Sport - 5.0 V8 petrol
 - 1 x LR011279 Oil filter
 - 2 x LR011593 Air filters
 - 1 x JKR500020 Cabin filter
 - 8 x LR032080 Spark plugs
 - Oil drain plug
 - 1 x 4594914 inc. rubber seal

Range Rover Evoque

- DA6089 Range Rover Evoque - 2.0 petrol
 - 1 x LR025306 Oil filter
 - 1 x LR029078 Air filter
 - 1 x LR056138 Cabin filter
 - 4 x LR025605 Spark plugs
 - 1 x LR025048 Oil drain plug

- DA6091 Range Rover Evoque - 2.2 diesel
 - 1 x LR001247 Oil filter
 - 1 x LR029078 Air filter
 - 1 x LR056138 Cabin filter
 - 1 x LR001313 Fuel filter
 - 1 x LR004304 Oil drain plug
 - 1 x LR006295 Oil drain plug seal

Service Sticker

SERVICE STICKER NEW
Helpful stickers to remind customers when they are due another service. Pack of 10



Clips, Clamps & Nipples



Exhaust Clamps			Jubilee Clips			Grease Nipples		
DA4062	45mm	Qty 10	CN100208L	20mm	Qty 10	TYL100030	Short thread	Qty 10
DA4186	54mm	Qty 1	CN100508L	32 - 52mm	Qty 5	TYL100030	Long thread	Qty 10
DA4063	60mm	Qty 1	CN100909	70 - 90mm	Qty 1			
DA4064	65mm	Qty 1						

Swivel Housing Grease



STC3435 370gm bottle
STC3435S 370ml sachet

- > Formulated for all Land Rover models with ball type swivel housings.
- > Lubricates swivel pins and housing seals, protects spheres.
- > A semi-fluid grease designed to withstand shock loading in oscillating joints.
- > Reinforced with solid lubricants, highly resistant to water and salt corrosion.
- > Better lubrication while driving, less leaks while standing.
- > One shot gives 'filled for life' protection.

NEW Sign up to the regular Britpart newsletter to find out about all the latest product releases.
www.britpart.com/newsletter

Hylomar Sealants & Compounds



RTC3347 Hylomar Universal Blue - gasket & jointing compound - 100g
Non setting universal jointing compound that is resistant to fuels, coolants and lubricants. Use on gaskets and machined metal surfaces. High temperature capability up to 250°C with unlimited assembly time. Easy disassembly for service maintenance and allows for differential thermal expansion of components. Excellent vibration resistance.

RTC3254 Hylomar 101 Silicone Sealant - gasketing, sealing & bonding compound - 85g
Engineering grade which forms any size or shape of gasket instantly and remains flexible and will not shrink. Bonds to metal, glass, ceramics, plastics, fibres and wood. Resists most solvents. Electrical insulator. Maximum constant operating temperature 250°C with neutral curing. Ensure surfaces are free from oil and grease.



STC4404 Hylomar 607 Silicone Sealant - 300ml
Engineering grade with excellent gap filling properties. Forms any size or shape of gasket instantly and remains flexible and will not shrink. Bonds to metal, glass, ceramics, plastics, fibres and wood. Resists most solvents. Good fluid resistance - not petrol or diesel. Electrical insulator with maximum constant operating temperature 250°C. Neutral curing. Tolerant of some oil and grease, ensure surfaces are clean.

STC4600 Hylomar 3400 Anaerobic Gasket Compound - 300ml
Excellent resistance to automotive fluids including fuels with an operating temperature -40°C to 150°C. Machined metal to metal surface only, not suitable for pressed steel. No gap filling. Latest generation anaerobic gasket compound. Single part product. Suitable for K-series engines. Ensure surfaces are free of oil and grease.

DA6441 Hylosil 100 Series Instant Gasket - 85g
Engineering grade amine curing RTC silicone sealant with a proven performance in aftermarket applications. Non corrosive. Forms any size or shape of gasket instantly. Remains flexible, will not shrink. Bonds to metal, glass, ceramics, plastics, fibres and wood. Resists most solvents. Electrical insulator. Ensure surfaces are clean and dry before use.

Bearing Grease



DA2391 Multi-pack of bearing grease 10 x 20ml sachets

Bulk Nut & Bolt Sets NEW

Save time and effort with these packs of 100 of the more common Land Rover nuts and bolts.

251323X NEW	Self locking nut x 100
302532X NEW	7/8 BSF P-Type Zinc/Clear
320045X NEW	Special nut x 100
509045PX NEW	Floor screw x 100
79221X NEW	Propshaft bolt x 100
AB614061LX NEW	3/8 UNF x 1 1/8 x 3/4
AFU1900X NEW	Screw for door hinge x 100
AM605061X NEW	Cone pointed UNF thread
BX110095MX NEW	Drive screw x 100
BYH500100X NEW	14 x 3/4 pan posi AB S/T zinc/clear
FRC3602X NEW	Screw x 100
FS108207LX NEW	Acme bolt X 100
FS108257LX NEW	5/8 x 3/4 hex head
FS108307LX NEW	Bolt - M10 x 45 patchloc x 100
LR045409X NEW	Bolt x 100
MRC2178X NEW	3/8 UNF x 1 1/2 hex head 3/8 thread
NH605041LX NEW	3/8 UNF x 1 1/2 patchloc x 100
NY606041LX NEW	Nut & retainer x 100
NZ606041LX NEW	Bolt x 100
	3/8 UNF x 1 1/2 hex head 3/8 thread
	Screw flanged head x 100
	20mm long M8
	Bolt x 100
	M8 x 25 flange hex head
	Screw x 100
	M8 x 30mm 8.8 grade zinc clear
	Bolt x 100
	3/8 UNF x 1 1/8 x 3/4
	Nut & retainer X 100
	Nut 3/8 UNF X 100
	Nut 3/8 UNF nyloc X 100
	Propshaft nut X 100
	3/8 UNF T-type nyloc



Got a great photograph of your Land Rover?
Why not enter the Britpart calendar competition for your chance to make your Landy a star. Full details can be found here - www.britpart.com/calendar

Automatic Transmission Fluid Change Kits

Degradation in oil can lead to judder, noise and a deterioration in gear change quality. It is recommended that oil and filters are changed after 50,000 to 75,000 miles on all 5, 6 & 8 speed automatic gearboxes to ensure optimum performance.

DA6085 Britpart pan with Ravenol oil
DA6085G ZF pan with ZF oil
Automatic transmission fluid change kit for vehicles with either a 6HP26 or 6HP28 ZF 6-speed automatic gearbox. Ideal for high mileage vehicles and towing vehicles. Kit comprises of pan assembly, transmission fluid, screws, sleeve & plugs.

DA6106 Britpart pan with ZF oil
Automatic transmission fluid change kit for vehicles with ZF 8HP70 8-speed automatic gearbox. Ideal for high mileage vehicles and towing vehicles. Kit comprises of pan assembly, transmission fluid, screws & plug.

Suitable for -
Discovery 4
Range Rover L322 - 2010 - 2012
Range Rover Sport - 2010 - 2013 & 2014 onwards

Suitable for -
Discovery 3 & Discovery 4
Range Rover Sport - 2005 - 2013
Range Rover L322

Also see DA2142 & DA2142G in transmission section.



Photo courtesy of Dan Levine

Workshop Consumables



SIJ500040	Brake fluid	500ml
STC50529	Brake fluid - Dot 4	1 litre
DA1122	Castrol Edge Professional A1 5W-20	1 litre
STC9158	Castrol Edge Professional C1 5W-30	1 litre
LR006247G	Castrol Syntans Multivehicle 75W-90	1 litre
LR003156LR	Castrol Axle EPX 80W-90	1 litre
TYK500010G	Castrol Differential SAF-XO SAE 75W-90	1 litre
DA6296	Castrol Valvemaster Plus Octane Boost	250ml bottle
DA6260	Castrol Classic XL 20W-50	1 gallon tin
DA6261	Castrol Classic XL 20W-50	1 litre tin
DA6262	Castrol Running In Oil No. 2	1 gallon tin
DA6263	Castrol R40	1 litre bottle
DA6264	Castrol EP140 Extreme Pressure API GL4	1 litre tin
DA6265	Castrol EP90 Extreme Pressure API GL4	1 litre tin
DA6266	Castrol Valvemaster Lead Replacement Additive	250ml bottle
DA6267	Castrol Valvemaster Plus Octane Boost	250ml bottle
DA6268	Castrol TQF	1 litre tin
DA6269	Castrol Red Rubber Grease	500g pot

DA1122	Castrol Edge Professional A1 5W-20	1 litre
DA6287G	Castrol Edge Professional C1 5W-30	1 litre
STC50531LR	Automatic transmission fluid 402	1 litre
STC4861	Transmission fluid – transfer box	500ml
STC9157 NEW	LubeTech Manual transmission fluid 94 API GL4	5 litres
VYK000010	Gear oil - MTF94	1 litre
STC9158 NEW	LubeTech Manual transmission fluid 94 API GL4	1 litre
STC4862G	Texamatic 7045E	1 litre
LR006247G NEW	Castrol Syntans 75W-90/API GL-4 Multi-vehicle manual transmission fluid	1 litre
STC4863G	Mobile ATF LT 71141	1 litre
TYK500050G	ZF Lifeguard Fluid	1 litre
LR003156LR NEW	Castrol EPX 80W-90	1 litre
IYK500010G NEW	Transfer Fluid TF-0870 - OEM	1 litre

STC50543	General purpose/brake cleaner	Land Rover	200ml
STC50544	General purpose/brake cleaner	Land Rover	400ml
STC50549	Paint and resin hand cleaner	Land Rover	400ml
LR023889	Leather & vinyl cleaner - Contents - 1 x 150ml leather protection cream; 1 x 150ml leather soft cleaner & 1 x sponge and cloth		

RTC6870VT	Touch up kit*	Land Rover	Alpine white
STC2864VT	Touch up kit*	Land Rover	Oxford blue
STC2828VT	Touch up kit*	Land Rover	Rioja red
STC1774VT	Touch up kit*	Land Rover	Epsom green
STC4235VT	Touch up kit*	Land Rover	Blenheim silver
STC4596VT	Touch up kit*	Land Rover	Oslo blue
STC2862A	Aerosol - 150ml	Land Rover	Monza red
RTC6401VA	Aerosol - 150ml	Land Rover	Windjammer blue

STC4676	De-icer	Land Rover	500ml
STC4672	Screen wash	Land Rover	250ml
STC4687	Screen wash	Land Rover	500ml
STC9155	Specialised lubricant	Land Rover	250ml
STC50550	Gasket adhesive	Loctite 5980	100ml
STC50551	Flexible adhesive sealant	Terostat 8596	300ml
DA6296 NEW	Oil additive, Friction modifier for Haldex units.		850ml
STC50519LR	Power assisted steering fluid/ACE		1 litre

Castrol Classic Oils

Castrol Classic Oils, total care and protection for your classic vehicle.

For much more information on each product and images visit www.britpart.com/castrol

A conventional multi-grade engine oil of good all round performance for pre-1980 modern classic cars.

DA6260 Classic XL 20W-50 1 gallon tin
DA6261 Classic XL 20W-50 1 litre tin

Mineral based, multi-grade, crankcase lubricant. Designed to facilitate running-in of new and reconditioned diesel and petrol engines.

DA6262 Running In Oil No. 2 1 gallon tin

Castrol R40 provides the ultimate in lubrication.

DA6263 R40 1 litre bottle

Originally specified grade for Series steering boxes and relays.

DA6264 EP140 Extreme Pressure API GL4 1 litre tin

Extreme pressure multi-purpose gear oil for hypoid and non-hypoid applications.

DA6265 EP90 Extreme Pressure API GL4 1 litre tin

Lead replacement fuel additive for use with lead-free fuel. Protects engine against valve seat recession under all driving conditions.

DA6266 Valvemaster Lead Replacement Additive 250ml bottle

Castrol Valvemaster Plus provides an octane boost to unleaded fuel, reducing pinking, knocking or the need to retune.

DA6267 Valvemaster Plus Octane Boost 250ml bottle

Transmission fluid for automatic gearboxes, incorporating additives to provide wear, oxidation and corrosion resistance.

DA6268 TQF 1 litre tin

A special, rubber compatible grease for use on hydraulic brake and clutch components where hardening or swelling of rubber must be avoided. Useful in assembly of rubber components for brake, clutch and suspension units.

DA6269 Red Rubber Grease 500g pot



Castrol Classic Oils Merchandise

Drink your tea in a nostalgic way with this large tin mug.

DA6270 Castrol Tin Mug

Use either to decorate your workshop or study or to accurately measure lubricant quantities shown in imperial measures in vehicle handbooks.

DA6271 Castrol Pouring Jug Half pint
DA6272 Castrol Pouring Jug Pint
DA6273 Castrol Pouring Jug Quart (two pints)

Smart green baseball cap with embroidered Castrol logo.

DA6274 Baseball Cap One-size fits all

Never forget to change your oil with this self-cling window sticker with Castrol logo on one side and Change Due boxes on the other.

DA6275 Window Service Sticker 3" diameter

Touch Up Paint Pens



The best you can get without repainting!

- > TUPP single stage paint pen is ergonomic, light and easy to use.
 - > It allows quick, one-step repairs of small scratches and nicks that may appear on any painted surface.
 - > It will meet the highest colour matching expectations.
 - > The patented valve mechanism and gravity action of the paint pen will give you an even flow of all components assuring the same particularities and brightness of the original finish.
 - > An edged polyester fibre tip allows accuracy and can be removed to be cleaned or replaced.
 - > The paint pen has a closed opaque container preventing accidental spills, hardening of the paint and colour change due to light exposure before the application.
- The Pen** - Paint is held in a barrel and automatically dispensed through a fine felt tip, providing the user unparalleled control over their painting instrument.
- The Paint** - High quality urethane paint is used which is the same as your vehicles manufacturer. The paint provides the user with a much closer colour match than other companies which primarily use lacquer paints.
- The Results** - The best you can get without refinishing the damaged areas.
- More details and FAQs can be found at www.britpart.com/paintpens

Exclusive to Britpart in the UK.

DA6217	Adriatic Blue	731	DA6471 NEW	Chile Metallic	944 (CAS)	DA6483 NEW	Nara Bronze	825 (AAJ)
DA6461 NEW	Aintree Green	866 (HGY)	DA6244	Cobar Blue	624 (JAV)	DA6228	Narvik Black	921
DA6237	Alaska White	909	DA6481 NEW	Colima Lime	829 (HAQ)	DA6240	Niagara Grey	574
DA6454 NEW	Aleutian Silver	835 (MMC)	DA6467 NEW	Corris Grey	873 (LKH)	DA6473 NEW	Orkney Grey	949 (KJZ)
DA6202	Alpine White	456 (NUC)	DA6204	Epsom Green	961	DA6213	Oslo Blue	644
DA6212	Alveston Red	696	DA6478 NEW	Estoril Blue	998 (JAE)	DA6205	Oxford Blue	602
DA6226	Arctic Frost	962	DA6463 NEW	Firenze Red	868 (CAH)	DA6201	Portofino Red	390 (CUF)
DA6476 NEW	Aruba Metallic	995 (GAT)	DA6462 NEW	Fuji White	867 (NDH)	DA6227	Rimini Red	889
DA6223	Atacama Sand	916	DA6218	Giverny Green	734	DA6206	Rioja Red	601 (CAQ)
DA6233	Atlantis Blue	632 (JYW)	DA6460 NEW	Havana	865 (AAN)	DA6207	Rutland Red	607
DA6468 NEW	Baltic Blue	912 (JEB)	DA6232	Icelandic Blue Mica	621 (JEL)	DA6259	Santorini Black	820
DA6457 NEW	Barolo Black	861 (PEH)	DA6458 NEW	Indus Silver	863 (MEN)	DA6470 NEW	Scotia Grey	943 (LAZ)
DA6465 NEW	Barossa Pearl	871 (KEB)	DA6242	Ipanema Sand	GAQ	DA6482 NEW	Siberian Silver	834 (MBP)
DA6230	Belize Green	756	DA6211	Java Black	697	DA6234	Silver Sparkle	MNH
DA6200	Beluga Black	416 (PUE)	DA6477 NEW	Kaikoura Stone	997 (BAG)	DA6235	Stornoway Grey	907 (LEL)
DA6236	Biarritz Blue	965	DA6239	Kent Green	647	DA6455 NEW	Tamar Blue	817 (JMC)
DA6245	Blenheim Silver	642	DA8044	Keswick Green	799 (HFU)	DA6238	Tangiers Orange	761
DA6214	Bonatti Grey	659	DA6231	Kinver Sand	609 (EAB)	DA6222	Tonga Green	904
DA6243	Borrego Yellow	757 (FUQ)	DA6469 NEW	Loire Blue	942 (JBM)	DA6224	Vesuvius Orange	811
DA6203	British Racing Green	617	DA6241	Lucerne Green	966	DA6215	Vienna Green	751
DA6220	Buckingham Blue	588 (796)	DA6464 NEW	Luxor	869 (GAA)	DA6208	White Gold	618
DA6221	Cairns Blue	849	DA6456 NEW	Mariana Black	860 (PEL)	DA6209	Woodcote Green	623 (HPE)
DA6229	Caledonia Blue	507 (JUT)	DA6480 NEW	Marmaris Teal	826 (JCK)	DA6479 NEW	Yulong White	2201 (NAK)
DA6474 NEW	Causeway Grey	950 (LNL)	DA6459 NEW	Mauritius Blue	864 (JYN)	DA6216	Zambezi Silver	737
DA6472 NEW	Chablis Green	945 (MMD)	DA6219	Maya Gold	846	DA6466 NEW	Zanzibar Brown	872 (EAR)
DA6210	Chawton White	603	DA6475 NEW	Montalcino Red	952 (CAX)	DA6225	Zermatt Silver	798



Photo courtesy of The Orritt Family

Ravenol Workshop Consumables



Much more information on each of these Ravenol products at www.britpart.com/ravenol

Engine Oils

Transmission Oils



DA6289 1 litre
DA6288 5 litres
SFE Super Fuel Economy 5W-20
Ravenol SFE 5W-20 is suitable for all petrol and diesel engines requiring a 5w20 grade fuel economy lubricant, and is especially developed to meet the requirements of the latest generation of Land Rover and Jaguar vehicles fitted with 5.0L V8 units.



STC4863 1 litre
ATF 5/4 HP Fluid
Ravenol ATF 5/4 HP Fluid is primarily designed for use in ZF 4HP-series (4HP20, 4HP22, 4HP24) and 5HP-series (5HP18, 5HP19, 5HP24, 5HP30) automatic transmissions.



DA6291 1 litre
DA6297 4 litres
DA6292 5 litres
FO 5W-30
Ravenol FO 5W-30 is a fuel economy engine oil, special product for modern gasoline and passenger car diesel engines.



STC50531 1 litre
ATF JF506E Fluid
Ravenol ATF JF506E is primarily designed for use in JATCO JF506E 5-speed automatic transmissions used in Land Rover Freelander.



DA6376 NEW 1 litre
DA6377 NEW 5 litres
FLJ SAE 5W-30
Ravenol FLJ SAE 5W-30 is a universal, fuel-saving, specially-composed motor oil for modern petrol and diesel engines both with and without turbochargers, for use in automobiles and vans with extended oil change intervals.



TYK500010 1 litre
TYK500010-20L 20 litres
VSG 75W-90 Gear oil
Ravenol VSG 75W-90 is suitable for use in both synchromesh and non-synchromesh gearboxes as well as being perfectly suited for use in highly stressed axle drives and differentials. Used in many high performance and motorsport applications as well as for road use in cars, light commercials and trucks where maximum protection and fuel economy are desired.



DA6378 NEW 1 litre
DA6379 NEW 5 litres
VMO SAE 5W-40
Universal synthetic low friction motor oil especially developed for pump-jet diesel engines. Moreover, this lubricant is suitable for gasoline and diesel engines in passenger cars and vans with and without turbo charger. Due to the specific composition Ravenol VMO SAE 5W-40 is suitable for use for several of the latest OEM requirements.



TYK500030 1 litre
MTF-2 75W-80 Gear oil
Ravenol MTF-2 SAE 75W-80 is ideally suited to ensure smooth and efficient operation of modern transmissions subject to very high mechanical and thermal loads of gear oils, even at the longest oil change intervals.



DA6368 NEW 1 litre
DA6369 NEW 5 litres
TSi SAE 10W-40
TSi 10W-40 is suitable for year round use in modern petrol & diesel cars. For use in turbo & non-turbocharged vehicles, multi-valve & direct injection diesel engines and is catalyst-compatible. Due to the specific high quality composition of TSi 10W-40, meets and exceeds the requirements of many leading OEM's, it also carries manufacturer approvals.



TYK500050 1 litre
TYK500050-4L NEW 4 litres
TYK500050-20L 20 litres
ATF 6HP Fluid
Ravenol ATF 6 HP Fluid was developed specifically for use in the latest ZF 6HP-series transmissions, 6HP19, 6HP21, 6HP26, 6HP28, 6HP32, 6HP34, also for 5-speed automatic transmission 5HP-series. It is backwardly compatible for all earlier versions of ZF 4.



DA6380 NEW 1 litre
DA6381 NEW 5 litres
Turbo-C HD-C SAE 15W-40
It is perfectly suited as all-season motor oil for the mixed fleet. It can be used in the commercial vehicle sector for operation and extended oil change interval (up to 45,000 kilometres are possible) according to manufacturer's specifications.



IYK500010 1 litre
Transfer Fluid TF-0870
Ravenol Transfer Fluid TF-0870 was developed for use in active transfer case (Active Transfer Case) and provides a stable viscosity even under the highest loads.



DA6372 NEW 1 litre
DA6373 NEW 4 litres
Ravenol ATF Dexron D II
It was developed for the use in automatic transmissions, hydro steering mechanisms, converters and power transmissions and can be used as a universal ATF (Automatic-Transmission-Fluid) for all vehicles and working machines.



LR002748 1 litre
ATF T-IV Fluid
Ravenol ATF T-IV Fluid was primarily developed for use in the latest Aisin Warner and Toyota transmissions found in many modern European and Japanese vehicles, and it's versatile formulation means it can also be used to replace older T, T-II and T-III fluids where required, as well as fulfilling many other manufacturer requirements.



STC4862 1 litre
ATF Dexron IIIH
Ravenol ATF Dexron III H was primarily developed for use in automatic transmissions with electronically controlled converter lockup clutch, but also suitable for use as a universal ATF and power steering fluid, especially where Dexron III is the required specification, and is backwards compatible for Dexron II applications.



LR003156 1 litre
EPX SAE 80W-90 GL
Ravenol Getriebeoel EPX SAE 80W-90 GL 5 is compatible with all brand-name transmission oils. In case of changing to Ravenol EPX SAE 80W-90 GL 5 flushing is not necessary. It can be used in manual transmissions, axle drives, distributor and intermediate transmissions in vehicles and working machines.



LR019727 1 litre
Multi-disc locking differentials semi-synthetic lubricant
Ravenol MDL multi-disc locking differentials was developed specifically for use in lamella limited slip differentials.

Power Steering



STC50519 1 litre
STC50519-20L NEW 20 litres
SSF Power steering fluid
Ravenol SSF Fluid is a special hydraulic fluid formulated using the latest synthetic technology blended with special ashless additives. It is designed for use from -40°C to +100°C and is therefore recommended for the latest developments in the vehicle market. Ravenol SSF Fluid is a special hydraulic fluid formulated using the latest synthetic technology blended with special ashless additives.

Coolants



DA6293 1.5 litres
DA6294 5 litres
OTC Organic technology coolant concentrate
Ravenol OTC Organic Technology Coolant Concentrate is an eco-friendly 1.2- Ethanediol (monoethylene glycol) based silicate, borate, nitrite and phosphate-free coolant for cooling circuits in combustion engines which provides maintenance-free corrosion and frost protection.

Grease NEW



DA4960 NEW 400g
DA4961 NEW 5kgs
Ravenol multi-purpose grease Ravenol Mehrzweckfett OML is a lithium based multi-purpose grease with oxidation and corrosion protective additives.

Diesel System Cleaner NEW



DA4962 NEW 300ml
Ravenol Diesel System Cleaner is a fuel additive for all diesel engines which cleans the fuel injection system and restores the full power of the engine, whilst increasing operational safety and improving fuel economy. It is a cleaning agent for electronically and mechanically controlled fuel injectors which allows for combustion with a low degree of soot and reduced particles whilst preventing rattling noises and rough idling.

www.britpart.com/ravenol



Ravenol the renowned German Manufacturer is one of the most technically innovative companies in the lubricants industry.

Ravenol prides itself on the special formulations, unique design and its exacting manufacturing processes that are individually tailored to suit customer needs.

This is why the demand for Ravenol product is growing worldwide.

In the advanced in-house laboratories products are carefully developed to meet and exceed the requirements of the major automotive manufacturers and to comply with all current and future regulations.

Across the globe, Ravenol has earned an enviable reputation for innovation and technical excellence.

Ravenol have developed an extensive range of products meeting and exceeding Land Rover requirements resulting in quieter running engines with improved fuel economy and smoother gear changes.

Whichever Land Rover/Range Rover model you drive, wherever and however you drive it, Ravenol have developed a lubricant to meet your specific requirements.

We at Britpart not only recommend the use of Ravenol lubricants in your Land Rover, but use them in our own fleet of Land Rovers, trucks and vans.

Oil Analysis Kit



DA6358 NEW
Oil analysis kit
Extend the life of both engine and transmission...
Lubetrend Analysis is the complete fluid analysis programme performed by the Number One oil condition monitoring laboratory in the UK with over 35 years of experience in monitoring all types of fluid lubricated and insulating oil systems; giving you the confidence to act.
Regular checks on the condition of the oil can extend the life of both engine and transmission and help spot potential problems long before they materialise. Our aim is to help you succeed in making the most of your vehicles and machinery through reducing unplanned downtime, extending oil drains and detecting potential future failure - before they happen. Essential not only for all aspects of motorsport - we'd recommend taking a sample after each event - but also recommended for your everyday transport as part of the annual service.
The price includes the sample kit and the full analysis report. Only the postage to the laboratory is your responsibility.

Sundries



DA6485 NEW
Brake cleaner 500ml
Ravenol brake cleaner is a highly effective solvent-blended brake cleaner aerosol for the degreasing and cleaning of brakes, brake linings and clutch parts.



DA6486 NEW
Silicone spray 400ml
Ravenol Silicone-Spray is a universal lubricant and slide release agent spray for use on all types of components. Specially developed for the lubrication, care and maintenance of all types of rubber, plastic and metal surfaces and components. The water-resistant and weatherproofing properties make it especially suitable in a marine environment. The quick drying formulation leaves a colourless and odourless coating which is physiologically inert, water-resistant, UV-resistant and weatherproofed.



DA6496 NEW
Copper paste 90g
Ravenol Copper paste is a lithium grease containing copper powder as a solid lubricant additive, anti-wear additives, and anti-corrosion properties. It is suitable for application to components which are exposed to high temperatures, strong pressures and corrosive influences. It reduces friction and wear, provides protection against corrosion and seizing and is used in the automotive industry for assembling disc brakes and exhaust systems.

Raptor **NEW**



Protect your Land Rover with Raptor

TOUGH & TINTABLE protective coating

Raptor is a highly durable protective coating that ensures protection against mechanical damage, fuels, hydraulic oils, rust, corrosion, salt water, damp, extreme temperatures and off-road muddy good fun.



- Raptor - Black Finish**
 - Raptor 4 litre kit
 - DA6382 NEW** 4 x 750ml bottles of Raptor
 - 1 x 1 litre Raptor hardener
 - DA6383 NEW** Raptor 750ml bottle
- Raptor - Tintable Finish**
 - Raptor 4 litre kit
 - DA6384 NEW** 4 x 750ml bottles of Raptor
 - 1 x 1 litre Raptor hardener
 - DA6385 NEW** Raptor 750ml bottle
- Hardener**
 - > High quality isocyanate hardener.
 - DA6387 NEW** Raptor 250ml hardener
- Degreaser Slow**
 - > Anti-static and anti-silicone panel wipe.
 - > Fast evaporation ideal for localised panel repairs.
 - > Aggressive degreasing action removes contaminants including silicones.
 - > Carefully formulated to avoid any attack on existing paint films.
 - DA6390 NEW** 1 litre tin
 - DA6391 NEW** 5 litre tin
 - DA6392 NEW** 500ml aerosol
- ACID#8™: Acid Etch Primer**
 - > Promotes paint adhesion to difficult substrates such as galvanised steel & aluminium.
 - DA6393 NEW** 450ml aerosol
- GRIP#4™: Universal Adhesion Promoter**
 - > Ready for use universal adhesion promoter for paints, adhesives and sealants.
 - > Ideal for difficult to reach areas such as around door handles and sills.
 - > Replaces the need for abrasion and prevents lifting.
 - DA6394 NEW** 450ml aerosol
- Raptor Traction**
 - > Slip resistant additive
 - > 1 sachet needed for 1 litre Raptor
 - > BSI Kitemarked
 - DA6484 NEW** 200g sachet
- Finishing Pads**
 - > High performance cleaning, conditioning & finishing pad.
 - DA6395 NEW** 10 x Fine pads
- Panel Wipe Cloths**
 - > White wipe that leaves the surface clean, completely grease & fibre-free.
 - DA6396 NEW** 140m roll with 350 sheets in convenient centre-feed box dispenser.
- Mixing Cups**
 - > Clear plastic 1,300ml mixing cups
 - DA6397 NEW** 25 qty
- Wooden Mixing Spatulas**
 - DA6398 NEW** 100 qty
- Schutz Gun**
 - > Specially constructed for the application of Raptor.
 - > Screws directly onto plastic bottle.
 - DA6386 NEW** Raptor application gun
- Gravity Fed Spray Gun**
 - > 1.7 tip with excellent transfer efficiency
 - DA6447 NEW** Professional automotive spray gun

- Surfaces***
 - > Painted surfaces
 - > Aluminium
 - > Steel
 - > Bare metal
 - > GRP
 - > Galvanised
 - > Plastics
 - > Wood
 - > Polyester fillers
 - > Glass
 - > SMC
 - Usage**
 - > Automotive
 - > Off-road
 - > Marine
 - > Commercial
 - > Industrial
 - > Agricultural
- *Some substrates require additional surface preparation before applying Raptor.

Customisable
Raptor is available in black and tintable versions. The tintable version can be altered to suit the colour of your vehicle by adding a small amount of automotive solvent paint. Raptor can be applied as a smooth finish through a very coarse finish.

- Features & Benefits**
 - > Easy to use: simply FILL - SHAKE - SHOOT®
 - > Easy to clean
 - > Provides excellent UV protection
 - > Waterproof - provides a water tight seal, keeping water out and protects new surfaces against rust
 - > Sound deadener (reduces noise and vibrations)
 - > Protects against rust, corrosion salt, damp and extreme temperatures
 - > High resistance to everyday and off-road use
 - > Abrasion and stain resistant
 - > Dries rapidly, is flexible
 - > Provides excellent adhesion
 - > No need to wax after application

- Application Areas**
 - > Chequer plate and grills
 - > Loading area
 - > Underbody protection
 - > Bumpers and bull bars
 - > Sills, side rails and steps
 - > Wheels and wheel arches
 - > Part and full vehicle overspray
 - > And much more...
- Application Methods**
 - > Raptor application gun
 - > Roller
 - > Brush

Watch online how easy it is to use at www.britpart.com/raptor



One half of this Discovery 1 corner bumper is a very tired looking, tatty and weather beaten bit of plastic. The other half is transformed with a coating of Raptor and it will stay like this as Raptor is UV resistant.

Loctite Consumables



The Loctite® brand, is renowned for the excellence of its adhesives and sealants. Since the original development of a unique anaerobic technology more than fifty years ago, Loctite® products have become vital components in many of the machines and products that are at the core of everyday life

Body Repairs		Glues & Adhesives	
DA6310 Freeze & Release	Shock freezing (-43°C) is a quick and convenient method for releasing seized and corroded parts.	DA6300 Super Glue	High performance instant adhesive with thousands of applications.
	400ml aerosol		3g tube
DA6312 Chemical Metal	The original rock-hard multi-purpose repair paste.	DA6301 Super Glue Brushable	Brushable version for extra accuracy and greater coverage.
	Mini blister pack	DA6303 Repair Express Power Putty	Fills, sticks, seals and re-builds thousands of items without tools.
DA6313 Leak Fix	Seals and repairs leaks in petrol tanks, radiators and sumps.	DA6304 Rear View Mirror Bonder	Unique bonding system for rear view mirrors, car telephone aerials and all window mounted material.
	Mini blister pack	DA6306 Stud 'N Bearing Fit	Locks and seals studs into position. Seals against leaks and vibration.
DA6316 Terodicht Elastic Window Sealant	Ideal for re-sealing rubber mounted windcreens.	DA6309 Instant Adhesive 401	Surface insensitive formulation creates a permanent bond with virtually any material.
	310ml cartridge	DA6314 Super Steel Epoxy-Weld	Sets like steel. Seals, repairs, bonds, fixes and replaces.
DA6317 Terolan Special Sealant	Vehicle body sealant for application with special brush.	DA6318 Fast Set Epoxy 3430	Two part general purpose epoxy adhesive.
	1.4kg can & brush		24ml syringe
DA6319 Teroson Etch Primer	Provides excellent adhesion to steel, galvanised steel and aluminium.		
	500ml aerosol		
DA6326 Zinc Spray	Sprayable anti-corrosion primer paint for vehicle body repairs.		
	400ml aerosol		
DA6327 Terotex HV 350	Electrically conductive (wet and dry). Allow to cure for 8-12 hours before over painting.		
	1 litre bottle		
DA6328 Terotex Record 2000	A solvent containing anticorrosive agent based on waxes, polymers and anti-corrosive additives. Contains high percentage of rust-proofing additives. Good creeping qualities. Penetrates to a depth of >35mm. Mild odour.		
	1 litre bottle		



For more information and images on our range of Loctite products visit www.britpart.com/loctite

Ravenol Classic Oils **NEW**



The need for Classic Oils?
Oils for modern engines need to comply with the latest API ratings and specific ACEA and OEM specifications concerned with improving fuel efficiency, extending oil drain intervals and exhaust treatment systems such as diesel particle filters.
A classic car engine has the opposite characteristics with cork/graphite/rope seals, low pressure gear driven oil pumps, larger oil galleries with greater dependence on "splash" and "cling" lubrication, lower revving with larger machining tolerances. This type of engine design demands a totally different lubricant. The new range of Ravenol Classic Oils offers formulations that have been specially blended to meet the requirements of older vehicles.
Special anti-wear additives with the correct amount of zinc (ZDDP) are added to ensure that metal to metal contact and irreparable engine damage is prevented, especially to camshafts and followers, which can wear out in only a few thousand miles when using modern oils. The careful selection of appropriate corrosion inhibitors, special dispersant additives and the correct levels of detergency protect against pitting, the build-up of gums, lacquers, sludge, soot and metallic ash – the normal by-products of combustion.

By using Ravenol Classic Oils in your classic Land Rover you are protecting both engine and transmission – for generations to come.



www.britpart.com/ravenol

For full product details and a video to see how easy it is to use visit www.britpart.com/raptor



Photo courtesy of Saul Underwood

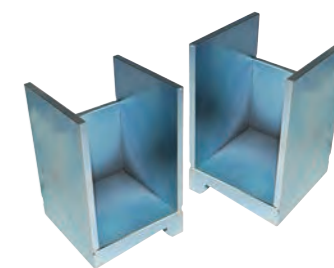

Photo courtesy of Alfred Schleicher

Calibration Tools



LRT-60-003
Air suspension calibration blocks for Range Rover P38. To be used in conjunction with Lynx diagnostics kit.



LRT-64-003
Air suspension calibration blocks for Discovery 2. To be used in conjunction with Lynx diagnostics kit.

Timing Tools



DA1115
Timing kit
Freelander 2 - 2.2 diesel
Land Rover tool part numbers -
303-1277 - Camshaft pulley timing pin
303-1270/303-1059 - Flywheel locking timing pin
303-1272 - Flywheel/ring gear locking tool adaptor



DA1116
Timing kit
Discovery 3 - 4.4 V8 - from 2005
Range Rover Sport - 4.2 V8 Supercharged - up to 2010 & 4.4 V8 up to 2010
Range Rover L322 - 4.2 V8 Supercharged - 2005 - 2010 & 4.4 V8 - 2005 - 2010
Jaguar 4.2 & 4.4 V8 engines with codes 4PN & 428PS



DA1121
Timing tool kit for Land Rover KV6 engines
The Land Rover KV6 quad cam engine has one front and two rear camshafts and these tools cover the replacement of all three belts



DA1120
Flywheel locking tools & camshaft timing pins
Discovery 3 - 2.7 TdV6
Range Rover Sport - 2.7 TdV6



DA6120 NEW
Fuel pump locking tool for use with DA1120 on 3.0 TdV6 engines.



DA1162
Flywheel locking tool
Defender - 2007 onwards
Land Rover tool part number - 303-698



DA3140
Timing kit - 2.5D/Tdi - 12 piece



LRT-12-058
Timing pin (short) - Td5
LRT-12-158
Timing pin (long) - Td5



Workshop Tools

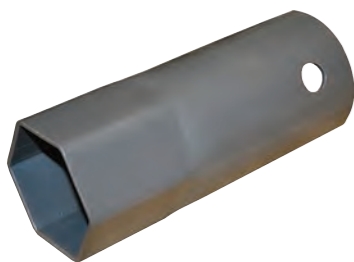

606435
Hub nut spanner



DA1111
Viscous fan coupling spanner
Two sizes - 32 & 36mm



DA1117
Td5 oil filter spanner



DA1235
Defender - Puma
Locking tool to restrain the fuel injector sprocket during a fuel pump removal/installation.



DA1118
52mm deep socket - 1/2" drive
Socket for adjusting hub nuts



DA1176
36mm oil filter socket - 3/8" drive
Designed to protect the corners of the filter from damage. Defender - Puma 2.2 & 2.4 Freelander 1 - Td4 Range Rover L322 - 2002 - 2009 - M57 3.0 diesel & M62 4.4 V8 petrol



LRT-12-094
Viscous fan coupling wrench
V8 petrol/Td5 diesel/V6 2.7 diesel/2.5 Td diesel/Td6 diesel/300Tdi

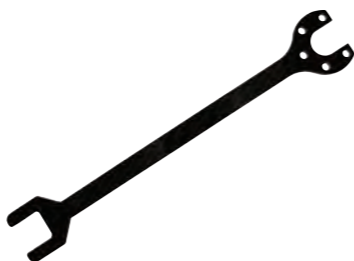

LRT-12-093
Viscous coupling holding tool
V8 petrol/Td5 diesel/2.5 Td diesel/300Tdi

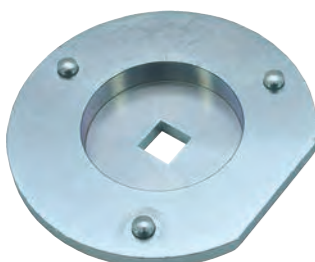

DA1161
Crankshaft front seal remover/installer tool
Defender - 2007 onwards
Land Rover tool part number - 303-679

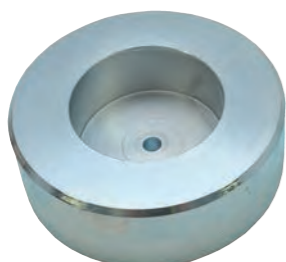

DA1160
Engine front casing alignment tool
Defender - 2007 onwards
Land Rover tool part number - 303-682



DA1147
Clutch tool
Defender - 2007 onwards
Discovery 3 - TdV6 manual
Replace two tools for one with this cost effective clutch tool. One end is the Land Rover 308-419 clutch alignment tool which is used to align the clutch disc and pressure plate on installation. The other end of the tool is Land Rover 303-1096 aligner/installer tool which is used to align the clutch drive plate and install the spigot bearing.



DA1209
For easy removal of the fuel tank metal locking ring (ESR3808) on the Defender - 2002 onwards, Discovery 1 Discovery 2 Freelander 1 Range Rover P38 Range Rover L322



DA1125
Ball joint remover tool kit.
Fit & remove RBG000010 to a Defender drop arm without having to remove the arm from the vehicle.



LRT-60-004
Bush fitting tool
For front radius arm bushes (part number ANR3332) for the Range Rover P38A - impossible to do without using this Land Rover special tool.



DA1153
Brake calliper rebuild tool kit
Anyone who has ever tried to rebuild a set of Land-Rover brake callipers will know that the most difficult part is fitting the dust seal after the pistons have been fitted. This extremely awkward task can now be made much easier with the seal fitting tools in this kit. The kit is supplied with a tool to fit 41mm and 44mm pistons and comes complete with a heavy-duty piston spreader to allow the seals to be pushed into place evenly.



DA1189
For removing and installing oil filters on diesel models of the Freelander 2 and Range Rover Evoque. 27mm combination spanner with flexi head. 400mm long. Manufactured from Chrome Vanadium. Fully polished with ratchet. Manufactured to Ansi standards.

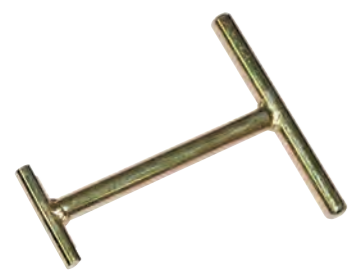

DA1173
Oil filter remover for the paper element from the canister. Prevents damage to the filter housing.
Discovery 3 - TdV6
Discovery 4 - TdV6
Range Rover Sport - TdV6
Land Rover tool part number - 303-1128



DA1155
Panel popper tool kit. 12 piece set designed to aid in the easy removal of door trim panels, trim fasteners and mouldings inside or outside the vehicle. Manufactured from a tough & durable engineering plastic to minimise panel damage. Inc. additional metal clip tool.

DA7460
Heavy-duty piston spreader only.



facebook.com/britpart



Prop Shaft Fastener Tools

- > Size - 3/8" 6 point (hexagon)
- > Total length - 150mm
- > Outside diameter - 20mm

Specialist socket for prop shaft fasteners on most Land Rovers. The 3/8" socket end is a perfect hexagon with rounded tip profiles to ensure the whole turning power is transferred onto the flanks of the nuts instead of on the corners. The socket's slim wall construction and wine glass profile, coupled to an integral slimline extension means it fits perfectly between the UJ yokes and over the prop shaft nuts without fouling. The 3/8" AF nuts are common to Series Land Rovers, Defenders (90 & 110 up to latest vehicles), Discoverys (up to and including Discovery 2) and Range Rovers (up to and including P38).

- DA1065** 3/8" square drive
- DA1119** 1/2" square drive



DA5631

Protect your Defender's wings with a pair of these sturdy, easy to fit wing protectors.



Automatic Transmission Flush & Fill Machine



Need a fast, effective, efficient and easy way to change automatic transmission fluid?

DA6800

A standard automatic transmission drain and re-fill will only change about 50% of the contaminated fluid. Wynn's TranServe™ will change about 90% of the contaminated fluid in around 20 minutes. Wynn's TranServe™ is a automatic transmission flush and fill machine which flushes the oil system of automatic gearboxes and which changes the ATF in a simple and effective way.

Properties

- > Cleans the oil system of automatic gearboxes with the Wynn's Automatic Transmission Flush.
- > High exchange rate of up to 90% compared to only 50% with a classic drain and fill.
- > No mixing of old and new fluid.
- > Easy connection to the transmission or transmission oil cooler lines.
- > Operates on the vehicle's battery (12V).
- > Automatically detects the correct flow direction.

Different functions:

- ATF exchange
- ATF top up
- ATF drain
- Adding additive
- > Addition of the product Wynn's Automatic Transmission Treatment:
 - Provides supplementary protection of the gearbox.
 - Smoothens gear changes and improves kick-down response time.
 - Extends life of the transmission fluid by preventing ageing and oxidation.
 - Stops and prevents leaks by revitalising seals and O-rings.

Applications

- > Recommended when changing ATF of automatic gearboxes or when experiencing shifting problems, fluctuating RPM or not retaining the correct gear.
- > For all types of cars but not to be used on high-pressure systems of buses, trucks, etc.



Automatic Transmission Service Kits
Use the Wynn's TranServe™ in conjunction with the range of automatic service kits from Britpart. For full kit details see the relevant pages in the service kit and transmission sections in the repair and service part of the catalogue.



Technical Data

- > Power source - 12V D.C. (vehicle battery)
- > Dimensions - 650mm W x 1,130mm H x 450mm D
- > Weight - 61 kg
- > Pump: min. flow - 4,5/min
max. flow - 5,5/min
max. pressure - 9 bar
- > Automatic flow detection
- > Reservoir for additives
- > 2 filters
- > Integrated printer
- > Adapter set for all cars



DA6801

Wynn's Automatic Transmission Flush

- Size - 325ml x 24 bottles
An oil soluble treatment developed to clean automatic gearboxes and restore their optimal operation.
- > Safely removes varnish deposits.
 - > Prepares transmission for new fluid.
 - > Cleans all internal transmission components.
 - > Smoothens and quietsens gear changes.
 - > Prolongs component life.
 - > Restores optimal gear shifting.
 - > Only to be used with TranServe machine.



DA6802

Automatic Transmission Treatment

- Size - 325ml x 24 cans
An oil soluble supplement developed to stop and prevent leaks and ease shifting.
- > Stops and prevents leaks.
 - > Rejuvenates rubber seals & O-rings.
 - > Cleans and protects the system by means of detergents & dispersants.
 - > Eases shifting.
 - > Prevents ageing and oxidation of automatic transmission fluids.
 - > Prolongs component life.
 - > 1 can of 325 ml treats up to 6.5 litres automatic transmission fluid.

Lighting



DA5063 NEW
High Power Mechanics Headlamp

- > 3W Cree LED provides 320 lumens of light output.
- > Operating times: 2.5hrs (high); 8hrs (med) & 18hrs (low).
- > Lamp adjusts through 50° to focus on work area.
- > Tough & robust impact resistant aluminium construction, ideal for a workshop environment.
- > Weatherproof design for outdoor use.
- > Adjustable headstrap with padding for comfortable usage.
- > 4 x AAA batteries included.



DA5027

Essential LED Inspection Pocket Lamp

- > Magnet for hands free use.
- > LED torch function for focused light output.
- > Protective lens for demanding conditions.
- > Integral swivel pocket clip.
- > Includes batteries.

Specifications

Battery 3 x AAA
Operating time 5hrs



DA5064 NEW
MAGflex Ultra Bright LED

- Inspection Lamp
- > Rechargeable and cordless.
 - > New strip LED provides 350 lumens light output while the torch provides 85 lumens.
 - > Multi-positioning for directional lighting.
 - > White light output simulates daylight.
 - > Optical lens provides wide angle uniform illumination.
 - > Magnet for hands free use.
 - > 2 x Integral hanging hooks.
 - > High power LED torch function.
 - > Anti slip comfortable grip.
 - > Li-ion battery for faster consistent recharging.
 - > Includes AC UK mains charger and 12v DC charging lead.
 - > 3 hour operating/5 hour charging time.



DA5026

Professional LED Inspection Pocket Lamp

- > Rechargeable and cordless for convenient use.
- > High powered LEDs provides a bright light output.
- > Anti-slip comfortable grip.
- > Magnet for hands free use.
- > LED torch function for focused light output.
- > Precision reflector provides wide angle light output.
- > Tough and robust polycarbonate lens for demanding conditions.
- > Lithium ion battery for faster consistent recharging.
- > Includes AC mains charging adapter with UK plug.

Specifications

Light output 120 lumens
Battery 3.7v 1200mAh
Mains adapter Input 240v - 50/60Hz
Output 5v - 300mA
Operating time 5hrs
Charging time 5hrs



Vehicle Enhancements

Make your Land Rover stand out from the crowd. Britpart have a great selection of vehicle enhancements available for all models. The wide range includes both exterior and interior accessories. From steering wheels to vent trim kits, there is something to suit everyone.

Defender	
Electrical	196
Exterior	194 - 195
Interior	197 - 199
Screw & bolt kits	200
Discovery 3 & Discovery 4	190 - 191
Freelander 2	193
Range Rover Evoque	192
Range Rover L322	186 - 187
Range Rover L405	187
Range Rover Sport - Mk1	188 - 189
Range Rover Sport - Mk2	189
Series	200



Range Rover L322



DA1071 Rear bumper cover
Stainless steel



DA1072 Oval rear badge surround
Metal - chrome finish

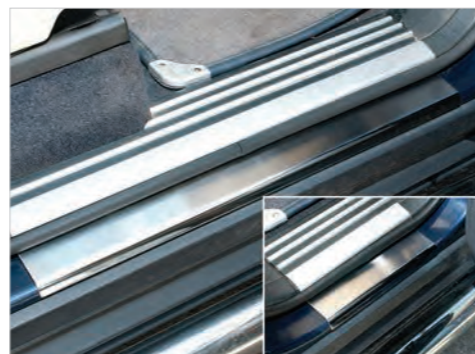

DA1073 Lower sill step covers - front & rear
Brushed finish
Pair

Range Rover L322 - continued



VUB001230 Side protection tubes
Stainless steel
Pair
Tubes can be fitted with or without front mudflaps.



VUB002510 Side protection tubes
Black steel
Pair
Tubes can be fitted with or without front mudflaps.



VUB503660 Side step including front mudflaps
EPDM (synthetic rubber) top and hard plastic trimming
Side step replacement insert moulding for VUB503660
Pair
VUB001300 Right hand side
VUB001310 Left hand side
Single
Single

Enhance the look of your Range Rover L322



DA5108 Replacement grille
Same as DHB500550LQV but with Brunel outer and chrome inner from VIN 6A



DA5653 Door handle cover - up to 2010
Plastic - chrome finish
Set of 4
DA5654 Door handle surround
Plastic - chrome finish
Set of 4



DA5655 Fog light bezels
2006 - 2009 (from 6A000001)
Plastic - chrome finish
Pair



DA4663 Heated leather steering wheel
Range Rover L322 Vogue - 2002 onwards.
Many of early L322 Range Rovers (Vogue shape) still look as good as new with only a few tell tale signs of their age and mileage but steering wheels on some models have gone all shiny and have lost the leather appearance and also steering wheels have started to sag. Range Rover improved the specification of the wheels on later models so they are much more durable. This wheel has the grained leather surface - not the smooth leather as used on the 2010 models. Please note that the spoke covers are not supplied with this steering wheel. You retain your original airbag/switch assembly - this is just the steering wheel frame as shown in the picture.



Air intake grille
JAK500300LQV Right hand side
JAK500310LQV Left hand side
Single
Single



VUB503650 Air intake grille
Plastic - chrome finish
Pair



VUB503880MMM Wing mirror covers - top
5A onwards
(adhesive STC50551)
Plastic - chrome finish
Pair
LR003905 Wing mirror covers - bottom
5A onwards
(adhesive STC50551)
Plastic - chrome finish
Pair



LR005239 A Bar
Moulded black plastic & includes spot lamp brackets



VUB001070LR Front lamp guard
Up to 2006
Black
Not compatible with wraparound protection bar



VUB001080LR Rear lamp guard
Black
Pair

Range Rover L405



DA4822 Loadspace protector
Semi-rigid foam with anti-slip finish and 2" deep sides



VPLGS0153 Umbrella holders
Excludes umbrella
Pair



VPLGP0100 NEW Side protection tubes
Pair



VPLGP0226 NEW Side steps
Pair



Powered side steps
VPLWP0191 NEW Left hand side
VPLWP0192 NEW Right hand side

Range Rover Sport - Mk1



DA1072 Oval rear badge surround
Metal - chrome finish



DA5660 Fog lamp surrounds
2005 - 2009
Plastic - chrome finish



Pair
DA3350 Plastic - chrome finish
Left hand side Single
DA3351 Right hand side Single
DA3352 Kit (DA3350 & DA3351) Pair



DA5667 Chrome finish
Air intake grille kit - 2010 Autobiography style
For 2002 - 2009 models



Pair
DA5668 Silver finish
Air intake grille kit - 2010 Autobiography style
For 2002 - 2009 models



Pair
JAK500320WWH Tungsten/Titan finish
Right hand side Single
JAK500330WWH Left hand side Single

Range Rover Sport - Mk1 - continued



Set of 8
EBN500040 Stainless steel
From AA000001 up to AA218728
VPLSS0042 AA218729 onwards



LR008713 Pedal set
Stainless steel & rubber
Set of 3



Pair
VTK500020 Side steps with thermo plastic elastomer side step top and brushed aluminium side trim



VUB501930 Front lamp guards
2005 - 2009
Black
Pair



VUB501920 Rear lamp guards
2005 - 2009
Black
Pair



Pair
VPLSP0010 Front lamp guards
2010 - 2013
Black
Pair

Enhance the look of your Range Rover Sport



LR006304 Air intake grilles
Metal - chrome finish



Pair
DA2997 Mesh grille insert - lower
Stainless steel with hand polished mirror finish
Note - 2005 - 2009 models only and not compatible with Adaptive Cruise Control (ACC) System.



DA5658 Door handle cover
Plastic - chrome finish
Set of 4
DA5659 Door handle bowl
Plastic - chrome finish
Set of 4



Headlight washer jet caps
DA5661 Chrome
Pair
DA7602 Zermatt Silver
Pair
VPLAB0025LML Primed
Pair

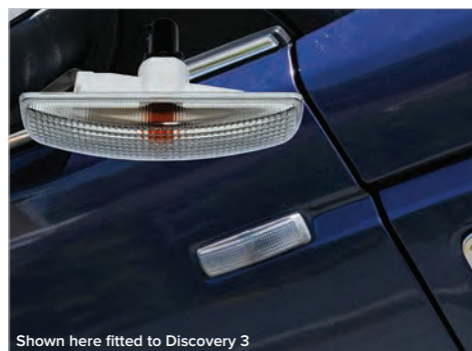

Indicator lamps with orange bulb
DA7610 Clear
Single
DA7611 Smoked
Single



VUB503880MMM Wing mirror covers - top
5A onwards
Plastic - chrome finish
Pair
LR003905 Wing mirror covers - bottom
5A onwards
Plastic - chrome finish
Pair



VPLTP0064 Rear lamp guards
2010 - 2013
Black
Pair



VUB501980 A Bar - moulded plastic
2005 - 2009 - includes spot lamp brackets
Grey



DA6290 Range Rover Sport - 2005 - 2011
Tailgate conversion trim kit with chrome strip
The rear tailgate on the Range Rover Sport changed in 2012 from a two piece tailgate (with opening top window section) to a one piece tailgate and above the registration plate a new silver strip was added that went the width of the tailgate. If you have a 2005 - 2011 model and want to make it look like the 2012 model from the rear you can fit this clever conversion kit. The kit consists of 3 panels - 1. Underside base - section made from ABS plastic in grey primer finish - you will need to paint this part black. 2. Top section - supplied in primed ABS plastic ready for painting body colour 3. Strip section - chrome plated plastic. This is a bolt on replacement kit that replaces the existing panels on the upper tailgate. The kit can be fitted with the tailgate on the car and you only need a Torx T20 driver socket and a 8mm socket.



DA6349 Range Rover Sport - 2005 - 2010 2.7 TdV6
Range Rover Sport - 2005 - 2009 3.6 TdV8
This FBH controller is ideal for warming your engine on cold winter mornings while sat in the comfort of your house, removing the need to go outside and start your engine to defrost the car which is especially handy if you have a car that has faulty glow or heater plugs. You can lock and unlock the vehicle without the heater stopping. It has a 30 min run time to aim for a default water temp of 76°C. For more details visit - www.britpart.com/DA6349

Range Rover Sport - Mk2



VPLGP0226 NEW Side steps
Pair
VPLWP0191 NEW Powered side steps
Left hand side
VPLWP0192 NEW Right hand side



Discovery 3 & Discovery 4



DA5662 Discovery 3 Fog lamp surrounds Plastic - chrome finish Pair



DA5664 NEW Discovery 4 Fog lamp surrounds Plastic - chrome finish Pair



DA5658 Plastic - chrome finish Door handle cover Set of 4

DA5659 Plastic - chrome finish Door handle bowl Set of 4



Headlight washer jet caps
DA5661 Chrome Pair
DA7602 Zermatt Silver Pair
VPLAB0025LML Primed Pair



Indicator lamps with orange bulb
DA7610 Clear Single
DA7611 Smoked Single



DA5669 Discovery 3 Side vent trim - Discovery 4 style Plastic - chrome finish Single



DA5670 Discovery 3 Side vent trim - Discovery 4 style Plastic - silver finish Single



JAK000065MMM Discovery 3 Side vent trim Plastic - stainless steel finish Single



VUB503880MMM 5A onwards Wing mirror covers - top (adhesive STC50551) Plastic - chrome finish Pair

LR003905 5A onwards Wing mirror covers - bottom (adhesive STC50551) Plastic - chrome finish Pair

Discovery 3 & Discovery 4 - continued



VTD500010 Discovery 3/Discovery 4 Side protection tubes Black steel Pair



VTD500020 Discovery 3/Discovery 4 Side protection tubes Stainless steel Pair



VUB501200 Discovery 3 Front lamp guards Black Pair



VUB501380 Discovery 3 Rear lamp guards Black Pair



VPLAP0008 Discovery 4 Front lamp guards Black Pair



VPLAP0009 Discovery 4 Rear lamp guards Black Pair



LR008713 Stainless steel & rubber Pedal set Set of 3



EBN500041 Discovery 3/Discovery 4 Side sill tread plate kit Stainless steel Set of 4



DA6349 Discovery 3 - 2.7 TdV6
This FBH controller is ideal for warming your engine on cold winter mornings while sat in the comfort of your house, removing the need to go outside and start your engine to defrost the car which is especially handy if you have a car that has faulty glow or heater plugs. You can lock and unlock the vehicle without the heater stopping. It has a 30 min run time to aim for a default water temp of 76°C. For more details visit - www.britpart.com/DA6349

Enhance the look of your Discovery 3 or Discovery 4



LR005237LR Discovery 3 A Bar Moulded rubber Includes spot lamp brackets



VPLAP0022 Discovery 4 - up to DA999999 A Bar Moulded rubber Includes spot lamp brackets Black



VTK500010 Discovery 3/Discovery 4 Side runners with polypropylene side step top and a brushed aluminium side. Pair



Photo courtesy of Celine Peniston Bird

Range Rover Evoque



Bonnet grille for 3-door Atlas
LR026593 RHS
LR026596 LHS

Bonnet grille for 3-door Dark Atlas
LR026592 RHS
LR026595 LHS

Bonnet grille for 3-door Black
LR032305 RHS
LR032306 LHS



VPLVP0071 Side protection tubes
 Stainless steel
 Pair

LR027486 Scuff plate - rear door

DA5557 Loadspace protector
 Semi-rigid foam with anti-slip finish and 2" deep sides

Enhance the look of your Range Rover Evoque



Photo courtesy of M. Belakov

Freelander 2

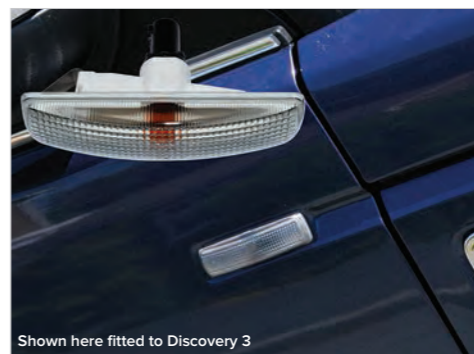

DA5663 Fog lamp surrounds
 Pre-facelift models only
 Plastic - chrome finish
 Pair

Indicator lamps with orange bulb
DA7610 Clear
DA7611 Smoked
 Single
 Single

VUB503880MMM Wing mirror covers - top
 5A onwards
 Plastic - chrome finish
 Pair
LR003905 Wing mirror covers - bottom
 5A onwards
 Plastic - chrome finish
 Pair



LR002464 Rear spoiler
 Easy to fit - no drilling
 Primed (as shown)

LR002408 Front lamp guards
 Black
 Pair

LR003685 Rear lamp guards
 Black
 Pair



LR002773 Side step
 Thermo plastic elastomer side step top and a brushed aluminium side trim.
 Pair

LR003318 Side protection tubes
 Stainless steel
 Pair

LR003319 Black bumper styling cover
 For vehicles with or without parking sensors.
 No spot lamp brackets.

Enhance the look of your Freelander 2



Photo courtesy of Darren Whiley



LR002525 Front and rear sill tread plate kit
 Polished stainless steel
 Set of 4

Defender

Exterior Enhancements



LR008361
Defender SVX style grille and headlight surround kit
Defender 2007 onwards
Note - Can be fitted to earlier Defenders with some modification.

Defender SVX style lights with manual headlamp levelling
VPLDV0001 Right hand drive kit
VPLDV0003 Left hand drive kit

DA1157 Brunel grey
DHH100780LQV RHS headlight surround
DHH100790LQV LHS headlight surround
LR038617 Grille
DAG500160 Black/silver logo grille badge
MXC6402 Green/silver grille badge

Enhance the look of your Defender

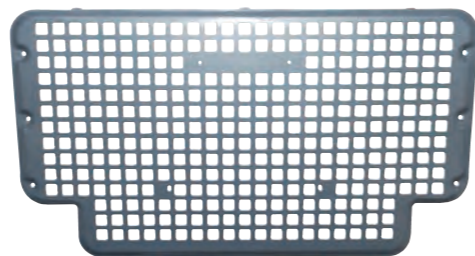

DA2356 Front grille - stainless steel with natural finish
Note - Will not fit Td5 vehicles with aircon.

DA2356B Front grille - stainless steel with black finish
Note - Will not fit Td5 vehicles with aircon.

STC60713 Heritage grille for non-air-con Defenders
Aluminium with silver/grey powder coated finish.

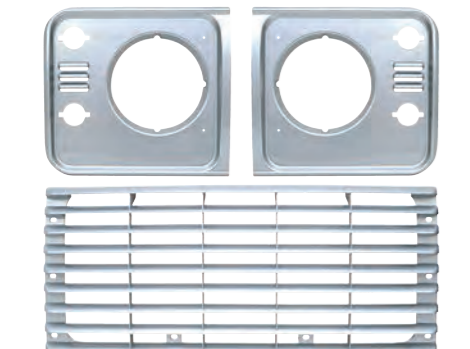

Indus Silver grille & headlamp surround
DA1257 Grille & headlamp surround set
LR059125 Grille
LR059126 Headlamp surround - RH
LR059127 Headlamp surround - LH

Santorini Black grille & headlamp surround
DA1357 Grille & headlamp surround set
LR051771 Grille
LR059128 Headlamp surround - RH
LR059129 Headlamp surround - LH

Air intake grille
DA4000 Steel - black Left hand side
DA4001 Steel - black Right hand side



Air intake grille
Stainless steel
Includes stainless steel screw kit
DA4000SS Left hand side
DA4001SS Right hand side

Manufactured from ABS plastic these cowls will help prevent snow, mud and leaves from entering the heater intake and reducing the Defender heater performance. Fitting a cowl will reduce moisture build-up in the intake system which can happen if debris collects in the one-way valve. The cowl fits over the existing grille and follows the profile of the Defender's wing.
DA1270 NEW Left hand drive
DA1271 NEW Right hand drive

DA1963 Puma bonnet White
This Puma GRP bonnet is half the weight of the original Land Rover bonnets and will fit Defender 90 - 1984 onwards/Defender 110 -1983 onwards. The bonnet has return edges on all four sides underneath for strength and to make it more rigid. It has strengthened hinge points and is supplied with stainless steel hinge bolts & screws.

Defender

Exterior Enhancements - continued



DPB104270S NEW Front bumper with silver finish

DPT100070 Rubber bumper end cap
Note - Does not include fixings DZM100080

Britpart have a wide range of replacement door hinges. For more information on these kits, turn to the repair and service section.



Replace your corroded Defender windscreen brackets with a pair of these smart CNC machined aluminium billet brackets which won't tarnish like the standard brackets. Kits include gaskets and bolts. For fitment to vehicles with hinge type windscreen 2 x reinforcement strap LR016671 are required.
DA1142 Silver anodised finish Pair
DA1142B Black anodised finish Pair

Replace your corroded Defender bonnet hinges with a pair of these smart CNC machined aluminium billet hinges which won't tarnish like the standard brackets. Kits include hinges, hinge bushes and stainless steel bolts.
DA1152 Silver anodised finish Pair
DA1152B Black anodised finish Pair

DA1179 Bulkhead vent hinge pin kit
Stainless steel 4 hinge pins



XGB100310L Indicator lamp with orange bulb
2007 onwards Clear Single
For many more enhancements turn to our extensive range of lights in the lighting section.

Mud flap brackets Galvanised Pair
DA1188 Front - equivalent to MTC3000 & MTC3001
Defender 90 & 110
DA1187 Rear - equivalent to MUC3986 & MUC3987
Defender 90

DA5699 Universal number plate mounting bracket
405mm wide x 110mm deep Black finish Single
Number plate not included.



XFC100550CH NEW Number plate light Chrome



facebook.com/britpart

Defender

Electrical Enhancements

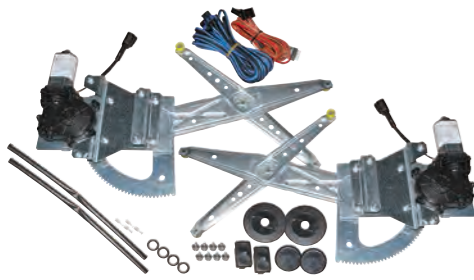

DA4664 Electric window kit
Defender - 2002 onwards
Fed up with winding your windows up and down? Make life easier, add electric front windows to your Defender with this comprehensive kit. Includes fitting instructions.



DA5717 Retrofit insert seat heaters
> Complete set for two seats
> Extra comfort with 2 heating levels - Stage I = pleasant permanent heat & stage II = heat-up.
> Installation kit for driver's seat and front passenger's seat with four heating elements.
> Pre-assembled cable set with switching relay and two illuminated switches for universal use.
> Integrated temperature guard.
> Heating elements made of extremely flexible coated wires.
> For seats with removable covers.
> Fitting materials & instructions.
Full details in the Seats & Trim section.

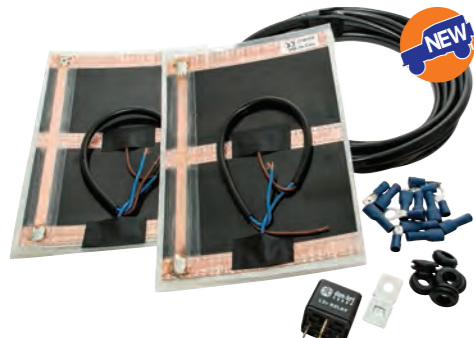

DA7481 NEW Voltmeter gauge
Defender - up to 2006
Defender - 2007 onwards with additional pod

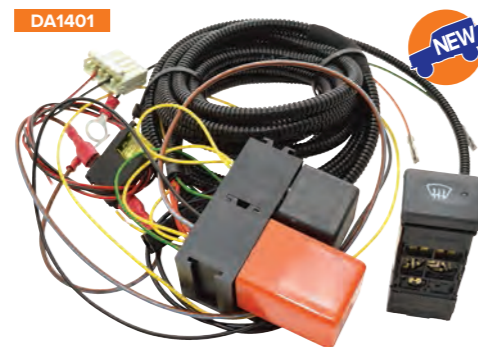

DA1401 Heated windscreen components
Make scraping your Defender's windscreen on a frosty morning a thing of the past by fitting one of these kits.
DA1400 NEW Carling Contura switch kit
DA1401 NEW Land Rover switch kit
DA1406 NEW Harness fleece tape - 19mm x 25m
CMB000411 NEW Tinted heated windscreen
Five way switch housing connector plugs
DA1402 NEW Black
DA1403 NEW White
DA1404 NEW Blue
DA1405 NEW Green
For more details and technical information on these kits - www.britpart.com/heated



DA4679 Dual USB charger
Easy to install in existing 12V DC socket hole providing convenient access for charging mobile devices.
> Compatible with popular mobile devices
> Protective cap
> Easy to use
Maximum output current - 2.1A DC (total)
Cut out dimensions - 1 1/8 in (28.58 mm) dia. hole
Input voltage - 12V
Output voltage - 5V DC +/- 5%
Parasitic current draw - 15mA
USB - 2.0



DA7480 NEW Plug and play cruise control system
Defender - 2007 onwards
Stalk fits to the right hand side of the steering column.



DA2342R Air conditioning kits
Front Kits
As OE fitment, no drilling required. Once fitted the system is indistinguishable from factory fitted units. Plugs straight into the existing Land Rover wiring loom and fuse board. Easy to install as components are pre-assembled. Kit uses high performance condenser which eliminates need for an extended nose cone. Parts interchangeable with Land Rover parts.
DA2343R Defender 90/110 - 300Tdi RHD
DA2342R Defender 90/110 - Td5 RHD
DA2342L Defender 90/110 - Td5 LHD
DA2344 Defender 90/110 - 2007 onwards RHD & LHD

Rear Kits NEW
The kit includes a new central box designed to house the unit, and the unit itself, plus the necessary hoses and interface manifold that connects to the front system. The central box comes complete and is a drop in replacement including a new floor plate for the vehicle, replacing the original floor plate that is beneath the cubby box or third seat if fitted.
DA6504 Defender 110/130 - 2007 onwards RHD & LHD
DA6506 Defender 110/130 - 300Tdi & Td5 RHD
DA6505 Defender 110/130 - 300Tdi & Td5 LHD
Note - All rear kits do not fit vehicles with automatic transmission. Kits DA6505 & DA6506 are for vehicles with the under dash air-con system already fitted.



Defender

Interior Enhancements



Interior side door handles
DA8935 NEW Black anodised aluminium Single
DA8936 NEW Silver anodised aluminium Single



Grab handles
DA8937 NEW Black anodised aluminium Single
DA8938 NEW Silver anodised aluminium Single



Door lever surrounds
DA8953 NEW Black anodised aluminium Pair
DA8954 NEW Silver anodised aluminium Pair



Vent knobs - up to 2007
DA8947 NEW Black anodised aluminium Single
DA8948 NEW Silver anodised aluminium Single



Heater control knobs - up to 2007
DA8945 NEW Black anodised aluminium Single
DA8946 NEW Silver anodised aluminium Single



Fuse box screws - up to 2007
DA8949 NEW Black anodised aluminium Single
DA8950 NEW Silver anodised aluminium Single



Locking pegs
DA8943 NEW Black anodised aluminium Single
DA8944 NEW Silver anodised aluminium Single



Gear lever and transfer gear lever set
DA5500 R380 gearbox Anodised alloy Pair
DA6600 LT77 gearbox Anodised alloy Pair
See trim section for gearbox gaiters.



DA5051 NEW Defender - Puma
A great replacement for your standard Defender gear lever. These polished aluminium gear levers are easy to fit with no modifications required. Just remove the plastic from the existing levers and swap with these high quality replacements.

Enhance the interior of your Defender



DA2610 Coin tray for Defender - 1987 - 2006



Glove box kit
Neat storage solution for the new Defender which utilises the available dashboard space. Ideal for storing all the usual small items you carry with you. Robust construction and easy to fit with all the necessary parts supplied. Suitable for right and left hand drive models.
DA2603 Defender - 2007 onwards
DA2603CF Defender - 2007 onwards Carbon fibre effect finish facia plate



Defender

Interior Enhancements - continued



AFP710120SS Loadspace mat retainer
Stainless steel strip with stainless steel fixings



DA1204 Rear door stays
Does your Defender's rear door sometimes close on you unexpectedly? This neat and easily installed gas strut kit will solve that problem and replaces the original door stopper. The gas strut will hold the door in place when open - even with a spare wheel in place - and will assist in the opening of the rear door too with a smoother and more controlled movement. Complete with fittings and instructions.

- DA1204** Defender - up to 2002
- DA1203** Defender - 2002 onwards



DA1205 Demister kit
Fitting this Defender demister kit will help demist your windscreen better than the standard fitted demister and has the added bonus that it will also demist your side windows too. With full fitting instructions.

PYP1000BLUE Bleed Screws
Smart replacement anodised aluminium bleed screws for the top hose on a Td5 engine.

- PYP1000BLUE** Blue
- PYP1000RED** Red



DA1170 SVX style cargo tie down point
Smart and easy to fit

ERR4686BLUE Replace your existing filler plug with one of these smart anodised aluminium ones. Suitable for use on a Defender, Discovery 1 & Range Rover Classic on the radiator and thermostat housing. Can also be used on the diff filler level on a Discovery 2.

- ERR4686BLUE NEW**
- ERR4686RED NEW**

DA8958 NEW X-Trouser
Lost a pair of trousers getting in and out of your Defender? Here is the simple solution. Not only does it protect your trousers, in many cases it makes the door close more reliably and helps (though it does not entirely stop) the seat belt getting caught in the latch. If the seat belt does become caught as you close the door, it suffers less damage due to the smooth profile of the X-Trouser. The X-Trouser has a smooth profile, if your belt loop or pocket runs over it, it will slide off freely. Made from high quality 304 grade stainless steel. The X-Trouser catch is reversible so it will fit both the driver and passenger doors, left & right hand drive. It will also fit the rear side doors of 110 Station Wagons.



DA4629 Roof consoles
This roof console fits all Defenders except sunroof equipped models. Supplied with interior lamp extension loom and DIN blanking panel. Fitting kit and instructions are also supplied. The console offers a unique storage solution for the Defender in providing additional overhead roof storage as well as a single DIN provision in one unit. The two side sections are designed to hold anything from maps to sunglasses, documents to magazines.



DA4629B The console is supplied in three separate pieces. The product has been designed with CAD software and the moulding finished off using CNC machinery to ensure an OE level fit and finish to the product. It is supplied with a DIN blanking panel but the central binnacle will fit any DIN sized accessory such as a stereo, CB/HAM radio or even a digital tachograph. The single DIN aperture will also accept a bank of seven Carling Technologies switches by using the Carling interlocking switch mounts.

Will the Defender roof console fit my vehicle?
The console has been designed to fit all post 1983 Defender models without a sunroof and with a factory headlining. The fixing method does not require removal or cutting of the headlining or sun visors. (Some later models will require trimming of the central area of the headlining when fitting a DIN unit). If you have a non-factory headlining it is unlikely it will fit without modification of the headlining. If you have a Series vehicle, again it is unlikely it will fit without modification.



DA1266 NEW Clutch pedal assist kit
Replace the old clutch pedal spring kit to assist the pressing of the clutch pedal on Defender models. This is a factory fit on later models but can be retro fitted to all 90/110 models. Consists of spring, spring retainer & spring bushes.

Defender

Interior Enhancements - continued

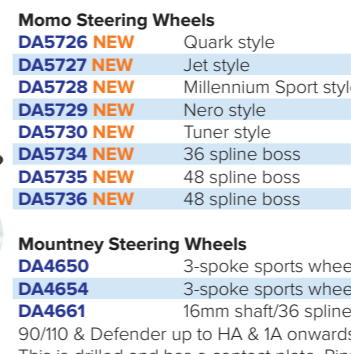

Momo Steering Wheels

DA5726 NEW	Quark style	Black/airleather	350mm
DA5727 NEW	Jet style	Black leather	350mm
DA5728 NEW	Millennium Sport style	Black/grey profile	350mm
DA5729 NEW	Nero style	Black/suede -	350mm
DA5730 NEW	Tuner style	Black leather	350mm
DA5734 NEW	36 spline boss		
DA5735 NEW	48 spline boss		
DA5736 NEW	48 spline boss	Defender 2015 onwards	

Mountney Steering Wheels

DA4650	3-spoke sports wheels	Black vinyl/black centre	380mm
DA4654	3-spoke sports wheels	Black vinyl/black centre	355mm
DA4661	16mm shaft/36 splines		
90/110 & Defender up to HA & 1A onwards			
DA4659	16mm shaft/36 splines		
90/110 & Defender up to HA & 1A onwards			
This is not drilled, pins are spaced at 28mm across, centre of splines casting is raised by 5mm			
DA4660	19mm shaft/48 splines		
Defender - JA onwards & Series 2 / 2A / 3			



DA8092 Dynamat Xtreme Sound Deadening
Dynamat Xtreme is the highest efficiency sound deadening material available and the most effective product for stopping noise and vibration. Xtreme can be used on any and all interior sheet metal and fibreglass body panels. The aluminium constraining layer is very moldable and conforms easily to all interior surfaces. The patented extra sticky butyl layer is formulated with VECTOR chemistry for the most amazing energy conversion capabilities ever. Use it on your doors, floor, roof, bonnet and loadspace for a quiet, cool and incredibly solid ride.



DA8083 Create a solid, luxury car feel with a reduction in road noise. Stop resonance & vibrations, reduces buzzes & rattles. Improved sound. Get more bass. Hear more of your music. For use throughout your vehicle interior, the first step to a great car.



DA8085 For use throughout your vehicle interior, the first step to a great car.

DA8091 NEW	Defender - 1983 - 1998	Bonnet
DA8093 NEW	Defender - Td5	Bonnet
DA8092 NEW	Defender - 2007 onwards	Bonnet
DA8094 NEW	Defender - 1983 - 2006	Foot wells
DA8083 NEW	Defender - 2007 onwards	Foot wells
DA8095 NEW	Defender - 1983 - 2006	Seat box
DA8084 NEW	Defender - 2007 onwards	Seat box
DA8085 NEW	Defender - 2007 onwards	Rear tub behind front seats
DA8086 NEW	Defender - 90 - 1983 - 2006	Rear tub floor
	Defender - 90 - 2007 onwards	
DA8087 NEW	Defender - 90 - 1983 - 2006	Rear wheel arches
	Defender - 90 - 2007 onwards - commercial only	
DA8088 NEW	Defender - 110 - 2007 onwards - Station Wagon/Utility	Rear arches
DA8089 NEW	Defender - 110 - 2007 onwards - Station Wagon/Utility	Rear floor
DA8090 NEW	Defender - 110 - 2007 onwards - Station Wagon/Utility	Second row floor/under seats
DA8076 NEW	Dynamat Xtreme sheet	1,200 x 610mm

The highest efficiency sound deadening material available.

More images available online at www.britpart.com



DA8089

Defender

Screw & Bolt Kits

Stainless Steel Bolt & Screw Kits

Using these smart stainless steel replacement bolt and screw kits will prevent rust from spoiling your Defender's bodywork - ideal for smartening up your vehicle or a restoration job. For more information on the kits contents please look online at www.britpart.com/bolts



Front & rear door - 4-door - bolt kit
DA1133 Defender
DA1133P NEW Defender - 2007 onwards

Front door - 2-door - bolt kit
DA1132 Defender
DA1132P NEW Defender - 2007 onwards

2nd row door - bolt kit
DA1260 NEW Defender
DA1260P NEW Defender - 2007 onwards

Rear door - hinge pin kit
DA1145 Defender/Series



Rear door - Safari - bolt kit
DA1134 Defender
DA1134P NEW Defender - 2007 onwards

Bonnet hinge - bolt kit
DA1135 Defender

Bumper - bolt kit
DA1139 Defender

Rear cross member to body - bolt kit
DA1136 Defender



Light lens - screw kit - sidelights, indicators and rear lights
DA1137 Defender - up to MA94004
DA1168 Defender - MA94005 onwards

Headlight panel - screw kit
DA1169 Defender

Front grille kit - screw kit
DA1138 Defender



JUST ADDED...

Defender - 2007 onwards
 Double din fascia plate
 This fascia kit allows the installation of a double din head unit into a non-double din size aperture. High quality finish designed to match the vehicle dashboard. Complete fascia kit, supplied with brackets to mount the aftermarket double din head unit.

DA2608 NEW Piano black
DA2609 NEW Matte black

Series



XFC100550CH NEW Number plate light Chrome



DA6110 NEW Chrome headlamp surround
 Series 1, Series 2 & Series 2A



Miscellaneous

This section contains a variety of products, including Britpart and Land Rover merchandise, workshop books and many other great gift ideas for any Land Rover enthusiast!

Books, Manuals & Technical Publications

Catalogues, manuals & more.....	202
Haynes books & manuals.....	202
Land Rover Original technical publications.....	203
Landy books.....	203
Mag books.....	203
Range Rover - The First Fifty.....	203

Camping Equipment

Camping chair.....	205
Fridge freezers.....	205
Fridge freezer remote monitor.....	205

Gifts & Merchandise

Britpart clothing.....	206
Britpart distributor merchandise.....	211
Britpart merchandise.....	207
Die-cast models.....	210
Haynes internal combustion engines.....	210
Land Rover merchandise.....	208 - 209
T-Shirts.....	206

Heavy-Duty Wiper Blades..... 204

Radiator Muffs..... 204

Security Marking Kit..... 204

Starting Handle..... 204

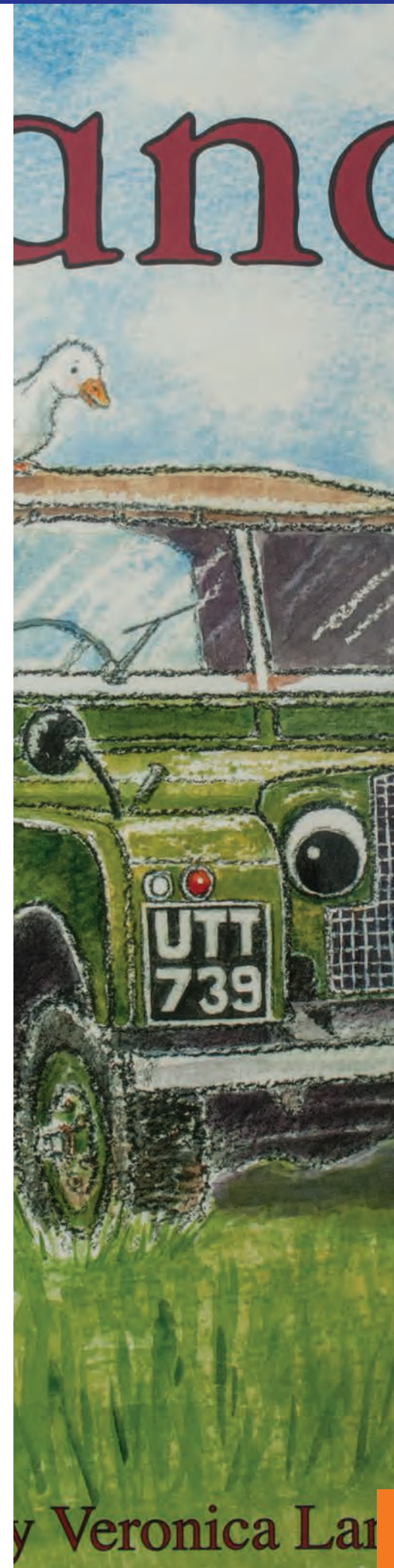

by Veronica Lar

Books, Manuals & Technical Publications

Haynes Books & Manuals

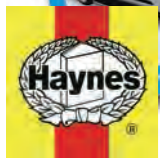

The worldwide market leader in automotive repair manuals

Defender		
DA3035	Owners Workshop Manual	90, 110 & Defender - 1983 - 2007 (up to 56 reg) - Diesel
DA3189	Modifying Manual	A practical guide to upgrades - By Lindsay Porter
DA3040	Restoration Manual	90, 110 & Defender - By Lindsay Porter REDUCED TO CLEAR
DA4558	Restoration Manual	90, 110 & Defender - By Lindsay Porter
Discovery		
DA2093	Haynes Extreme	Discovery - The definitive guide to modifying - By Emmeline Willmott
DA3036	Haynes Service & Repair Manual	Discovery - 1989 - 1998 (G to S reg) - Petrol & Diesel
DA3106	Enthusiast Guide	Discovery - By Dave Pollard
DA4493	Owners Workshop Manual	Discovery - Nov 1998 - July 2004 (S to 04 reg) - Diesel
DA4505	Owners Workshop Manual	Discovery - Aug 2004 - April 2009 (04 to 09 reg) - Diesel
Freelander		
DA4565	Owners Workshop Manual	Freelander - 1997 - Oct 2006 (R to 56 reg) - Petrol & Diesel
DA4588	Owners Workshop Manual	Freelander - Nov 2006 to 2014 (56 to 64 reg) - Diesel
Range Rover		
DA3042	Restoration Manual	Range Rover Classic - By Dave Pollard
DA3048	Haynes Service & Repair Manual	Range Rover Classic - 1970 - Oct 1992 (up to K reg) - Petrol
Series		
DA4636	Owners Workshop Manual	Series 2, 2A & 3 - 1958 - 1985 (up to C reg) Petrol & Diesel
DA3041	Restoration Manual	Series 1, 2 & 3 - By Lindsay Porter
General Interest		
DA3044	The Off-Road 4-Wheel Drive Book	- Choosing, using and maintaining go anywhere vehicles By Jack Jackson
DA4506	Enthusiast Guide	Military Land Rover 1948 onwards (Series 2, 2A to Defender) Insight into the history, development, production & roles of the British Army's light 4-wheel drive vehicle. Off-Road Driving Manual By Vince Cobley & Dave Phillips.
DA4566	Step-by-step instruction for all terrains. This extensively illustrated step-by-step manual is aimed at all drivers wishing to learn to drive safely and successfully off-road, whether for the occasional trip across a field or to prepare for an off-road expedition in a remote part of the world.	



Catalogues, Manuals & More...

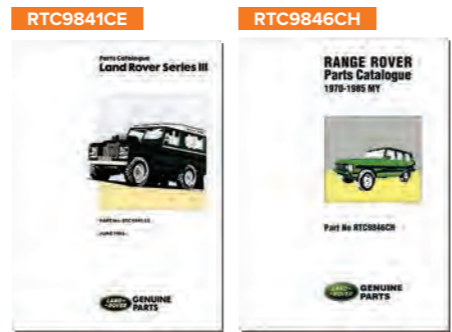

Parts Catalogues	
RTC9840CC	Series 2A - Bonneted Control
RTC9842CE	2A, 3 & 109 V8 - Optional Equipment
RTC9841CE	Series 3
RTC9863CE	One Ten
STC9021CC	Covering vehicles up to August 1986 Defender 90/110/130
RTC9947CF	Discovery 1 Covering 1989 - 1998 - 2.0 Mpi/3.5/3.9 V8 petrol & 200Tdi/300Tdi diesel engines
RTC9846CH	Range Rover Classic - 1970 - 1985
STC9049CA	Discovery 2 - Covering 1999 - 2003
RTC9970CE	Range Rover P38 Covering 1995 - 2001 - 4.0/4.6 petrol & BMW 2.5 diesel engines

Handbooks	
DA3162	Defender 90/110/130 Covering 1991 - February 1994 - 2.5/3.5 V8 petrol & 2.5/200Tdi diesel engines Defender 90/110/130 Covering March 1994 - 1998 - 2.5/3.5 V8 petrol & 2.5/300Tdi diesel engines
LRL0087ENG	Discovery 2 - Covering 1999 - 2004



Workshop Manuals	
DA3157W NEW	Defender Td5 workshop manual
DA3157E NEW	Defender Td5 electrical manual
DA3147	Freelander 1 - 2001 - 2003 onwards Includes V6 petrol engines
DA3148	Range Rover L322 - 2002 - 2005* Workshop manual Range Rover L322 - 2002 - 2005* Electrical manual
DA3149	Includes electrical library and electrical circuit diagrams
*Covering BMW 4.4ltr petrol V8 engines & BMW 3.0L diesel engines	
Other Publications	
DA3156	Winch In Safety - A5 hand book by Land Rover with pictures throughout.
LRL0178ENG	Replacement service portfolio



Landy Books

These charming hardback books, which are beautifully written and illustrated by Veronica Lamond, are an excellent gift idea for any Land Rover fan - whatever their age!



LANDY
"Landy has been left abandoned for many years until, one day, Jack finds him..."



LANDY NEW HOME
"Jack and Landy are busy setting up their small holding but Landy feels left out. When Fender arrives, Landy realises he hasn't been forgotten after all..."

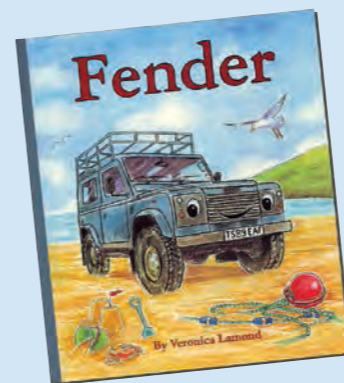

FENDER
"Scamp races Fender down the track - they have lots of things to do and lots of friends to meet..."

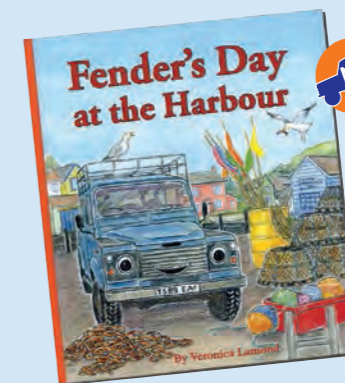

FENDER HARBOUR NEW
"Fender watched the fishermen fixing their boats and the swing shovel at work. Meanwhile, Dan and Jack weren't having much luck..."

Range Rover - The First Fifty

DA3202
Range Rover - The First Fifty Prototypes
YVBs and NXC's - the story of the early Range Rovers.

Today, the Range Rover is a legend. The original design lasted in production for more than a quarter of a century. It is those very first Range Rovers which are the subject of this book. Its aim is to record the story of the earliest vehicles before it becomes lost in the mists of legend and distorted by commercial misrepresentation. It looks at three distinct groups of vehicles. These are the Engineering Prototypes (of which there were seven), the Pre-Production Vehicles (of which there were 28, most registered in the YVB-H series), and the Press Launch Vehicles (of which there were 20, all registered in the NXC-H series). The total comes to slightly more than 50 vehicles. With 160 illustrations and 160 pages.



Mag Books



DA3188B Issue 2
From the publishers of Land Rover Monthly a 228 page celebration of the Defender including vehicles through the ages, rebuilds & repairs and buyers guides.
DA2988
From the publishers of Land Rover Monthly a 220 page celebration of the Discovery. Buying, restoring, modifying, driving - the ultimate Land Rover Discovery guide.

NEW Sign up to the regular Britpart newsletter to find out about all the latest product releases.
www.britpart.com/newsletter

Land Rover Original Technical Publications

Here are the original Land Rover and Range Rover publications needed to run and maintain your classic Land Rover or Range Rover, including parts catalogues, service manuals, technical information, owners literature and more. What's more, with these DVDs you can find information and links to Land Rover, Land Rover Heritage and Original Technical Publications. Discover more about the history of Land Rover, Land Rover and Range Rover models and get the latest Heritage news and information. You can also find links to local Land Rover and Range Rover Clubs, the latest picture galleries, video and media archives - you can even download classic Land Rover and Range Rover wallpaper to personalise your computer.

Original parts books, workshop manuals and handbooks for Land Rovers and Range Rovers have always been greatly sought after, and rightly so: nothing compares to a Land Rover workshop manual compiled by the car's manufacturer. Now owners and enthusiasts have the opportunity to effortlessly collect all the original publications for their favourite Land Rover or Range Rover, on one handy and cost-effective DVD.

See www.britpart.com for much more in depth information about what is included on each DVD.
Far too much to list here!

Handy & easy to use!

LTP3001	Series models - 1948 - 1985
LTP3003	Land Rover 90, 110, 127 & Defender 90, 110 & 130 - 1983 - 2006
LTP3004	Discovery 1
LTP3006	Discovery 2
LTP3016	Discovery 3
LTP3017	Discovery 4 - 2009 - 2012
LTP3007	Freelander 1
LTP3002	Range Rover Classic
LTP3005	Range Rover P38
LTP3008	Range Rover L322 - 2002 - 2006
LTP3015	Range Rover Sport - 2005-2009

System Requirements
PC - Windows 2000 or later. DVD Reader, Safeguard Windows PDC viewer. Must have administration rights to allow installation. **Mac** - OS X 10.4 or above. DVD Reader, Safeguard OSX PDC viewer Mac iOS 5.01 and above. Safeguard Mac iOS viewer. **Android** - 4.0 and above, Safeguard Android viewer.
Important - Documents are viewable but not printable through Mac OSX or Mac iOS. To print using a Mac you must be running a Windows installation e.g. using PC emulation software.

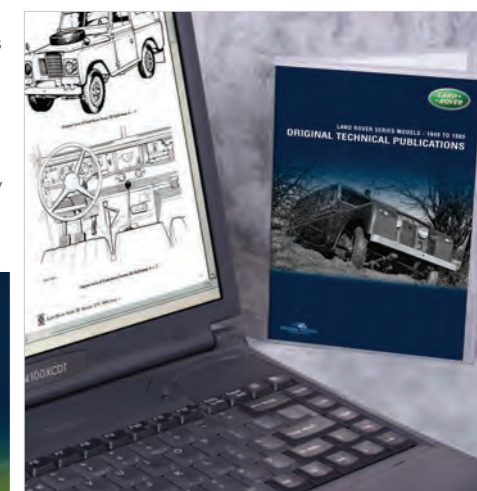
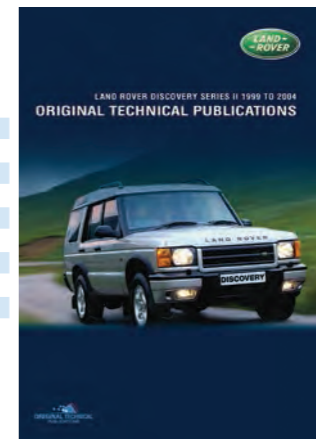

Product Features

- > Printable - print only the pages you need (Windows & Android only).
- > Viewable - from DVD or via online access (single user license).
- > Searchable - search the entire section in seconds.
- > Zoom - zoom in to see the exact details.
- > Bookmarked - manuals are bookmarked to quickly locate sections.

Radiator Muffs



Series 2/Series 2A - early models	Defender	Discovery	Black edging
DA4025BLACK	DA2161BLACK	DA2153	Discovery 1 - up to LA
DA4025BLUE	DA2161BLUE	DA2157	Discovery 1 - MA onwards
DA4025BROWN	DA2161GREEN	DA2163	Discovery 2 - square headlights
DA4025GREEN		DA2162	Discovery 2 - round headlights

Series 2A - late models/Series 3
DA2160BLACK
DA2160BLUE
DA2160GREEN

Note - The radiator muffs are black with either black, blue, brown or green coloured edging.

Control the flow of air into your radiator with a quality British made radiator muff!

Starting Handle

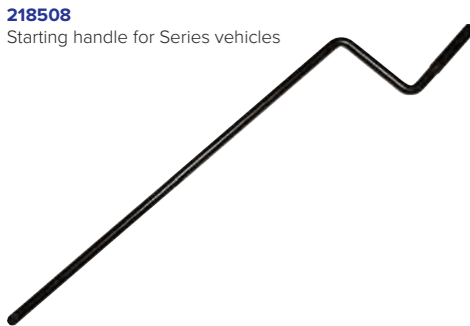

Heavy-Duty Wiper Blades



Note - These winter wiper blades should not be used at high speeds, it is a winter blade designed for harsh conditions.

Security Marking Kit NEW



DA8533 NEW
The International Security Register (ISR) system has proved successful in deterring and detecting theft and fraud for over 30 years. It works on the principle that if a vehicle's windows and parts are marked using robust techniques and details are recorded on a secure database - supported by a 24/7 verification service - criminals stealing the vehicle will run a real risk of being caught and prosecuted. Each mark applied to a vehicle will contain a unique 8-digit code, the ISR logo and www.isrcodecheck.com

Pack Components

- > Full instructions on marking and registering a Land Rover are in the security marking kit.
- > 8 vinyl stencils, fluid and brush for marking windows.
- > 2 warning decals.
- > 2 sets of 6 UV self-etch labels for application to painted metal body panels.
- > 2 sets of 7 ultra-destruct labels with UV fluid and applicator for identifying plastic parts.
- > A set of three Britpart branded security tags for increasing the chance of items that are so often mislaid, being returned to the owner.
- > A Britpart branded ISR customer contact card.

Reducing the risk of your Land Rover being stolen or cloned.

Registration of Vehicle and Owner Data on the ISR
The vehicle owner - or the dealer - would complete the registration process online via the Britpart registration page at www.TheISR.org then select "All Vehicles" then "Vehicles" followed by "Britpart Registration Form" entering the unique code together with the vehicle make, model, colour, VIN and VRM together with the owners name and contact details. If an email address is supplied, an automated acknowledgement of registration would be sent. The code for the security tags would be automatically recorded.

Camping Equipment NEW

Fridge Freezers



DA6545 NEW
35L Portable ARB Fridge Freezer
Great for short trips or as a second fridge, the 35L Fridge Freezer suits many compact SUV's due to its low height and small footprint.

Capacity - 35 litres (50 x 375ml cans)
Cooling capacity +10°C to -18°C
Weight 20.7kg
External dimensions 428mm (H) x 380mm (W) x 705mm (D)
Internal dimensions Fruit & Dairy Compartment: 126mm (H) x 285mm (W) x 151mm (D) & Main Compartment: 321mm (H) x 285mm (W) x 337mm (D)
Power - Built-in 12/24V DC and 100-240V AC power with integrated battery protection system

DA6546 NEW
47L Portable ARB Fridge Freezer
Suitable for many medium to large SUV's, the class leading 47L ARB Fridge Freezer is your perfect travelling companion.

Capacity - 47 litres (72 x 375ml cans)
Cooling capacity +10°C to -18°C
Weight 22.5kg
External dimensions 508mm (H) x 380mm (W) x 705mm (D)
Internal dimensions Fruit & Dairy Compartment: 206mm (H) x 285mm (W) x 151mm (D) & Main Compartment: 401mm (H) x 285mm (W) x 337mm (D)
Power - Built-in 12/24V DC and 100-240V AC power with integrated battery protection system

DA6547 NEW
60L Portable ARB Fridge Freezer
Perfect for family trips or off road touring, the 60L Fridge Freezer features a low profile to suit roller drawer systems, larger 4WDs, boats & camper trailers.

Capacity - 60 litres (90 x 375ml cans)
Cooling capacity +10°C to -18°C
Weight 24.5kg
External dimensions 428mm (H) x 450mm (W) x 845mm (D)
Internal dimensions Fruit & Dairy Compartment: 126mm (H) x 355mm (W) x 151mm (D) & Main Compartment: 321mm (H) x 355mm (W) x 477mm (D)
Power - Built-in 12/24V DC and 100-240V AC power with integrated battery protection system



Internal features

- > **Dairy compartment** - optimised internal capacity includes separate compartment for fruit and dairy products.
- > **Reversible basket with divider** - multiple storage options by separating fridge contents or alternatively allowing longer items to be positioned along the length of the cabinet.
- > **Drain plug** - integrated into fridge base for effortless cleaning.
- > **Integrated evaporator** - designed as an integral part of the interior cabinet, ensuring simplified cleaning and optimum use of internal storage space.
- > **Internal LED light** - low power draw LED light with magnetic switch turns off when lid is closed.

External features

- > **Secop compressor** - highest quality, Secop Compressor with smart electronic control system enables rapid cool down to target temperature.
- > **Durable detent hinge** - stainless steel detent hinge ensures the lid can be easily released and securely slid back into place.
- > **Rear clips** - rear clips secure 12/24v and 100-240v cables, preventing the plug from being accidentally disconnected.
- > **Lid with integrated seal** - tough, two piece injection moulded lid incorporates a recessed seal, preventing excessive wear and damage.
- > **Front latch** - simple to use, large over-centre cam lock latch provides a positive seal between the lid and cabinet for maximum cooling efficiency.
- > **Control panel** - easily accessible, recessed front control panel with maintenance-free digital temperature display (no dedicated battery required).
- > **Recessed handles** - powder coated steel handles, engineered to double as tie down points.
- > **Durable case** - powder coated, robust zinc steel cabinet sides designed to withstand extreme off road conditions.
- > **Rubber feet** - integrated into fridge base for increased grip and stability.

Fridge Freezer Remote Monitor

DA8933 NEW
The ARB Remote Fridge/Freezer Monitor allows you to monitor the operating condition of your ARB fridge/freezer from the comfort of your driving seat.

- > Multiple receiving channels for minimised transmission disruptions.
- > Large easy viewing backlit display.
- > Ability to monitor 2 ARB fridge/freezers.
- > 30m (100ft) line of sight or 15m(50ft) interrupted transmission.
- > Quick release bracket for easy removal of LCD display.
- > Temperature displayed in either °C or °F.
- > Power supply 12V.



Camping Chair



DA8929
ARB Air Locker camping chair is rated to 120kg and has a host of features, including a padded seat and backrest, convenient drink holder pouch, side pocket with Velcro flap for your keys, wallet or other small items, and a mesh magazine pocket on the rear of the backrest. Manufactured from durable nylon Oxford weave material, the chair also comes with a matching carry bag for compact storage and transportation.

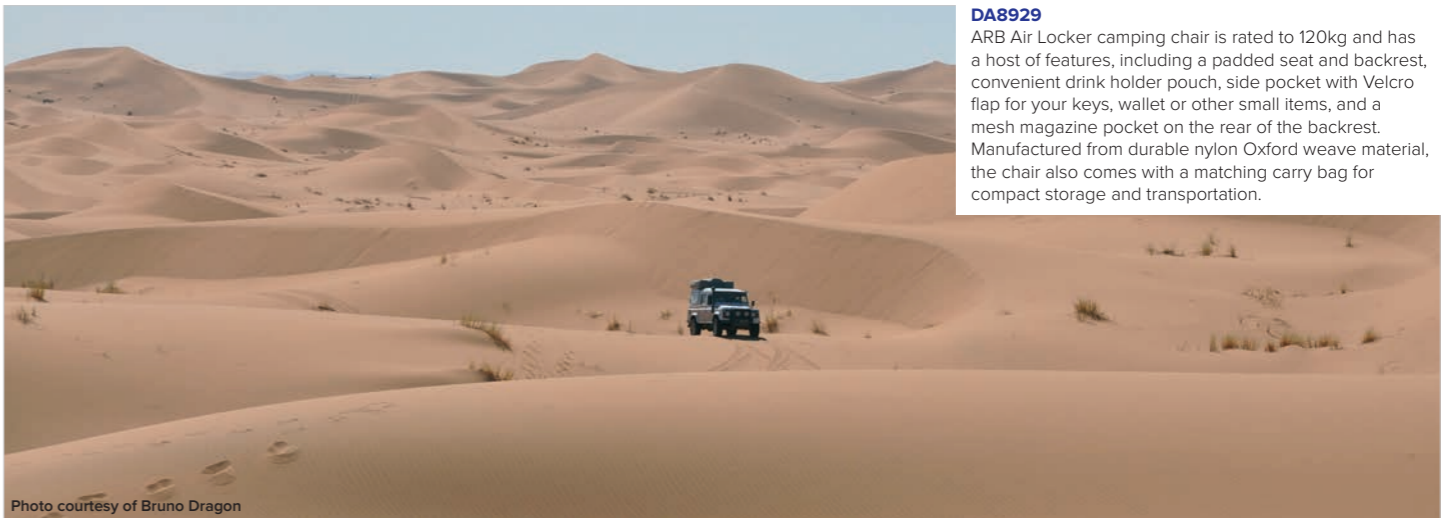

Photo courtesy of Bruno Dragon

Gifts & Mechanise

T-Shirts **NEW**



Exclusive to... **BRITPART**

A great gift idea!

- > 100% cotton
- > Reactive dyed
- > Crew neck
- > Taped shoulder to shoulder
- > Twin needle stitching on neck & shoulders
- > Enzyme washed for extra soft hand-feel and reduced shrinkage

Union Jack Flag

Grey t-shirt	
DA8051 NEW	Small
DA8052 NEW	Medium
DA8053 NEW	Large
DA8054 NEW	X-Large
DA8055 NEW	XX-Large

Because the earth...

Grey t-shirt	
DA8056 NEW	Small
DA8057 NEW	Medium
DA8058 NEW	Large
DA8059 NEW	X-Large
DA8060 NEW	XX-Large

Wheels

Grey t-shirt	
DA8061 NEW	Small
DA8062 NEW	Medium
DA8063 NEW	Large
DA8064 NEW	X-Large
DA8065 NEW	XX-Large

Headlights

Grey t-shirt	
DA8066 NEW	Small
DA8067 NEW	Medium
DA8068 NEW	Large
DA8069 NEW	X-Large
DA8070 NEW	XX-Large

Steering Wheels

Beige t-shirt	
DA8071 NEW	Small
DA8072 NEW	Medium
DA8073 NEW	Large
DA8074 NEW	X-Large
DA8075 NEW	XX-Large

For a better image of the t-shirt designs go to www.britpart.com/tshirt



facebook.com/britpart

Britpart Merchandise



DA8000 Mouse & mug mat set



DA8002 Key ring - karabiner style



Note
Picture shows both sides

DA8023 Key ring - plastic



DA8027 Key ring - bottle opener



DA8003 Ball point pen - pack of 10



Note
Picture shows both sides

DA8004 Mug - single



DA8015 Stainless steel travel mug



DA8017 Drawstring bag



DA8016 5" Teddy bear



DA8082 **NEW** 7" Panda bear



DA8024 300mm Ruler



DA8025 Ice scraper



DA8026 Calculator



DA8036 Pen pot



DA8037 Pocket LED torch



DA8038 Note book - 190 x 250mm



DA1229 Defender stress toy



DA8043 Credit card wallet



DA8042 Air freshener - cool wave scent. Pack of 5



Photo courtesy of David Sherwood

Britpart Clothing



T-Shirts	
DA8029	Medium
DA8028	Large
DA8020	X-Large
DA8050 NEW	XX-Large

Polo Shirts	
DA8045	Small
DA8005	Medium
DA8006	Large
DA8007	X-Large
DA8008	XX-Large
DA8080 NEW	XXX-Large

Sweatshirts	
DA8046	Small
DA8009	Medium
DA8010	Large
DA8011	X-Large
DA8012	XX-Large
DA8081 NEW	XXX-Large

Fleeces	
DA8047	Small
DA8040	Medium
DA8041	Large
DA8018	X-Large
DA8019	XX-Large

Hats	
DA8013	Ski hat
DA8021	Baseball cap

Fleece Body Warmers	
DA8077 NEW	Small
DA8078 NEW	Medium
DA8079 NEW	Large
DA8049	X-Large

Land Rover Merchandise



LRDCA3EVOG
Range Rover Evoque - 3 Door
1:43 scale die-cast model



LRDCA5EVOG
Range Rover Evoque - 5 Door
1:43 scale die-cast model.



LRDCADISCO
Discovery 4
1:43 scale die-cast model.



LRDCA405
Range Rover L405
1:43 scale die-cast model.



LRDCA494
Range Rover Sport - 2014 onwards
Chile Red
1:43 scale die-cast model



LRDCA494G
Range Rover Sport - 2014 onwards
Corris Grey
1:43 scale die-cast model



LRSS12RHW
Premium soft and supple fine and heavy grained black leather wallet with Alcantara lining detail and multi-card and note compartments.



LRSS12RCCW
Premium soft and supple fine and heavy grained black leather card holder with Alcantara lining detail and multi-card sections.



LRSPANN Land Rover Navy Small
LRSPANNL Land Rover Navy Large
LRSPANGS Land Rover Black Small
LRSPANGL Land Rover Black Large
LRSPANRSL Range Rover Sport White Large



Hard cover lined 152 page notebook featuring Land Rover or Range Rover Sport branding on the cover and page details. These notebooks also feature an expandable inner pocket.



Large notebook - 150 x 210mm
Small notebook - 90 x 140mm



LRSPABACBP
Contemporary styled and polished chrome Cross ballpoint pen with subtle Land Rover branding.



LRUNIACMUG14 NEW
Land Rover Union flag mug. Provides a unique take on the Land Rover logo.



LRICONMUG14 NEW
Icon mug. This mug features the terrain response icons from Land Rover vehicles.



LRCORPMUG14 NEW
Land Rover logo mug.



LRCEAHUEG
Green stoneware mug with raised embossed HUE 166.



LRO 2798
The vacuum-insulated Range Rover travel flask helps keep beverages hot or cold.



Photo courtesy of Ronny Jacobsen

Ideal **birthday** or **Christmas** gifts for any **Land Rover** enthusiast - whatever their age!

Land Rover Merchandise - continued



LRKRANHUE
Cast metal enamelled alloy keyring taking inspiration from the original licence plate of the Series I, the HUE 166.



Chromium plated keyring with matt finish & double thickness leather loop keyring with pull to twist mechanism.
LRKRALLK Brown & ivory
LRKRALLKR NEW Red
LRKRALLKI NEW Ivory
LRKRALLKB Black



LAKR272SLA NEW
Land Rover silver oval key ring embossed with the Union flag.



LRKRALS NEW
Discovery Sport key ring.



LRTOAHT20UK NEW 20cm
LRTOAHT30UK NEW 30cm
Children's bears with soft plush fur and Land Rover branding to their neck ribbon.



LRADVENTUREBEAR NEW
Made from soft touch, plush fur and with a Land Rover logo on his shirt. Suitable for ages 3 or more.



LAGF276BNA NEW
Land Rover rugby bear. This cuddly bear features a distinctive Land Rover Rugby top with XV logos and made from comfortable, easy-wear 100% cotton.



LRLOGOCAPN NEW Navy
Classic 3D embroidered Land Rover Oval. Adjustable strap with a Land Rover branded buckle. 100% Cotton.



LRLOGOCAPB NEW Black



LBCH113GNA NEW Green
100% cotton otterman baseball cap. 3D silicone Union Flag oval, Terrain Response icons and a Land Rover branded buckle.



LBCH113NVA NEW Navy



LACH015BLA NEW Bright blue
100% cotton otterman baseball cap, 3D silicone Union Flag oval and a Land Rover branded buckle.



LACH015GMA NEW Grey



LACH015RDA NEW Deep red



LRBCB37 NEW 3 to 7 years
LRBCB812 NEW 8 to 12 years
3D icons of the Land Rover Defender on the front. Made from 100% organic cotton.



UMAGBG Blue
Manual opening golf umbrella with lightweight fibreglass shaft and windproof system. Polyester single thickness canopy with grey logo print on one panel.



LRUMAGB NEW Black



LRUMAGBR NEW
30" automatically opening golf umbrella. Grey outer canopy with contrasting red lining and fibreglass frame.



LRUMAPN NEW Navy
LRUMAPB NEW Black
Lightweight aluminium, automatic open and close mechanism. Flat profile design for ease of storage, complete with a fabric case.



Many more **NEW birthday** or **Christmas** gifts for any **Land Rover** enthusiast - whatever their age!

Die-cast Models

 DA1219	 DA1223	 DA1221								
 DA1222	 DA1220	 DA1232								
<p>Collectable and detailed die-cast metal 1:18 scale model DA1219 Range Rover Evoque - 2-door Red This very detailed die-cast Evoque replica is not a toy and is not suitable for children under 14. The model is 245mm long x 120mm wide x 95mm high. It has detailed engine and interior parts with opening doors, boot and has a button under the chassis to open the bonnet, even the side mirrors fold on this superb scaled replica which is a must for all collectors and enthusiasts.</p>		<p>Collectable and detailed die-cast metal 1:43 scale model DA1254 Series 1 Export version Green</p>								
<p>Collectable and detailed die-cast metal 1:24 scale models</p> <table border="0"> <tr> <td>DA1223 Defender - 2007 onwards</td> <td>White</td> </tr> <tr> <td>DA1221 Discovery 4</td> <td>Silver</td> </tr> <tr> <td>DA1222 Range Rover Evoque - 2-door</td> <td>White</td> </tr> <tr> <td>DA1220 Range Rover L322</td> <td>Silver</td> </tr> </table>		DA1223 Defender - 2007 onwards	White	DA1221 Discovery 4	Silver	DA1222 Range Rover Evoque - 2-door	White	DA1220 Range Rover L322	Silver	<p>Collectable and detailed die-cast metal 1:76 scale model DA1232 Series 1 Flat Back Green</p>
DA1223 Defender - 2007 onwards	White									
DA1221 Discovery 4	Silver									
DA1222 Range Rover Evoque - 2-door	White									
DA1220 Range Rover L322	Silver									



Haynes Internal Combustion Engines

 DA4817	 DA4310	<p>DA4817 Build a fully functional, motorised model of a V8 petrol engine. Features sound recorded from a real V8 and illuminating spark plugs. The kit contains nearly 300 pieces and all that you need to assemble the model. It is supplied with a Haynes style manual giving you clear step-by-step instructions as well as interesting information about real V8 engines.</p> <p>DA4310 Build a realistic working model of a combustion engine. Includes light and sound features, light up spark plugs, moving pistons, valve gear, fan belt and 'Haynes Manual'. Finished model size - 180 x 270 x 140mm (H x W x D)</p>
--	---	---

Build a working model of an engine.



Britpart Distributor Merchandise

	 DEFENDER STICKER Britpart cartoon Defender stickers 100 x 60mm Qty 20
 EXTERIOR STICKER High tack vinyl gloss stickers 300 x 90mm Qty 20	 INTERIOR STICKER Self-cling window stickers 220 x 70mm Qty 20
 LOGOBOARD Britpart logo on 3mm foamex board 900 x 300mm Qty 1	 SERVICE KIT LEAFLET Britpart service kit leaflet 99 x 210mm Qty 25
 CATALOGUE Britpart accessory catalogue 210 x 297mm Qty 5	 CARRIER BAG Britpart branded carrier bags 380 x 470mm Qty 50
 POSTER SET Britpart A2 poster set 380 x 470mm Qty 8	 DA8042PACK Britpart branded air freshener Cool wave scent 100 x 65mm Qty 25
 DA8048 Britpart branded note pads A5 with 50 pages per pad Qty 10	 DA8023PACK Britpart key rings Qty 25

Please ask the sales team for details...





Part Number	Page Number	Part Number	Page Number	Part Number	Page Number	Part Number	Page Number	Part Number	Page Number
67187	54	572068PY-YELLOW	125	ASR1595	163	DA1112	108	DA1209	182
201691	54	572180PY	125	AWR5698RPI	76	DA1113	157	DA1211	131
218453	165	572180PY-YELLOW	125	AWR5699RPI	76	DA1114	166	DA1212	131
218508	40, 204	575580PY	125	AWR5700RPI	76	DA1115	181	DA1213	149
234532	173	575580PY-YELLOW	125	AWR5701RPI	76	DA1116	181	DA1214	149
241283	130	602153A	156	AWR5702RPI	76	DA1117	182	DA1215	122, 161
242139	55, 58	602154A	156	AWR5708RPI	76	DA1118	182	DA1216HD	160
242863	130	606683S	152	BIC710260	162	DA1119	183	DA1219	210
243123	130	606696S	152	BL4136BUSH	133	DA1120	181	DA1220	210
264563	130	79221X	173	BTR1759LCS	76	DA1121	181	DA1221	210
265627	130	90577434PY	125	BTR277	15	DA1122	174	DA1222	210
279678	130	90577434YELLOW	125	BTR3793LCS	80	DA1123	135	DA1223	210
279679	130	AAP817	157	BTR7895	67	DA1125	182	DA1224	83
306460	165	AB614061LX	173	BTR7896	67	DA1126	54	DA1224SN	83
320647	77	AEU1523	164	BTR7897	67	DA1127	155	DA1225	84
320674	77	AEU1525	164	BTR7898	67	DA1128	120	DA1227	10
320698	77	AEU2147LX	154	BTR7959LCS	80	DA1129	120	DA1229	207
320699	77	AFP710120SS	198	BTR9712LCS	80	DA1129ADJ	120	DA1232	210
320726	77	AFU1900X	173	BTR9712LOY	80	DA1129G	120	DA1233	122, 161
320737	77	AGP780020LR	28	BTR9712PMA	80	DA1129KIT	120	DA1234	131
330326	165	ALQ710020K	10, 99	BX110095MX	173	DA1129ULTRA	120	DA1235	182
330327	165	ALR1742	162	BYH500100X	173	DA1130	120	DA1236	148
330336	165	ALR1743	162	CAB500070PMA	30	DA1131	162, 165 - 166	DA1238	88
330337	165	ALR5822	163	CAB500130PMA	30	DA1132	200	DA1239	88
330422	80	ALR5823	163	CARRIER BAG	211	DA1132P	200	DA1239EU	88
330426	165	ALR6121	162	CAS000150PMA	15	DA1133	200	DA1240	162, 166
330427	165	ALR6122	162	CAS100900	15	DA1133P	200	DA1240SS	162, 166
330999	75	ALR6272	163	CAS100910	15	DA1134	200	DA1241	160
331401	64	ALR6677	162	CAS100920	15	DA1134P	200	DA1242	120
331670	64	ALR6678	162	CAS100930	15	DA1135	200	DA1243	120
332951	75	ALR6681	163	CAS500010PCL	15	DA1136	200	DA1244	120
345510	38	ALR6682	163	CAS500060PMA	15	DA1137	200	DA1245	120
345985	11	ALR6852	162	CAS500070PCL	15	DA1138	200	DA1246	120
347474	165	ALR8519	163	CAS500180PMA	15	DA1139	200	DA1247	120
349943	76	ALR8520	163 - 164	CAS500190PMA	15	DA1140	18	DA1248	120
349967	77	ALR8572	163	CAT000180PMA	15	DA1141	104, 150	DA1249	120
390055	164	ALR8573	163	CAT101160	15	DA1142	195	DA1252	158
390381	164	ALR8576	163	CAT101170	15	DA1142B	195	DA1253	158
390382	164	ALR8577	163	CAT500010PCL	15	DA1143	47 - 48	DA1254	210
391127	164	ALR8710	166	CAT500060PMA	15	DA1143CL	48	DA1255	88
391141	164	ALR9803	162	CAT500070PMA	15	DA1144	48	DA1256	88
391546	164	ALR9804	162	CAT500120PCL	15	DA11442V	47 - 48	DA1257	194
392222	164	ALR9877	163	CAT500340PMA	15	DA1145	200	DA1260	200
392223	164	ALR9878	163	CAT500350PMA	15	DA1146	51	DA1260P	200
395529	165	AM605061X	173	CAT500360PMA	15	DA1147	182	DA1261G	155
395530	165	AMR2341DELAY	153	CAT500370PMA	15	DA1148	120	DA1262G	155
396739	77	AMR3850	48	CAT500410PMA	15	DA1148CAP	120	DA1263G	155
517588	130	AMR6513LED	48	CAT500450PMA	15	DA1149	120	DA1264G	155
517589	130	AMR6514LED	48	CAT500540PMA	15	DA1152	195	DA1265G	155
532268	148	AMR6515LED	48	CATALOGUE	211	DA1152B	195	DA1266	158, 198
535173	130	AMR6515LEDCL	48	CMB000411	196	DA1153	182	DA1267	66
537179	40	AMR6526	48	CN100208L	173	DA1155	182	DA1268	10, 99
559822	165	AMR6526LED	48	CN100508L	173	DA1156	40	DA1269	10, 99
562631	130	AMR6526LEDCL	48	CN100909	173	DA1157	194	DA1270	194
562632	130	AMR6527	48	CQB000140	162	DA1158	50	DA1271	194
576521	84	AMR6527LED	48	CWV500010	162	DA1159	155	DA1272	108
579408	54	AMR6527LEDCL	48	DA1003	87	DA1160	182	DA1273	48
589783	48	AMR6528	48	DA1004	87	DA1161	182	DA1274	47
606435	182	ANR1721PY	125	DA1043	157	DA1162	181	DA1274CL	47
251323X	173	ANR1721PY-YELLOW	125	DA1044	157	DA1164	122	DA1275	166
302532X	173	ANR1799A	122	DA1045	157	DA1165	152	DA1275SS	166
320045X	173	ANR2056	162	DA1057	155	DA1166	152	DA1291	47
320647CB	77	ANR2563PY	125	DA1057PLUG	155	DA1167	152	DA1292	47
320647CG	77	ANR2563PY-YELLOW	125	DA1059	18	DA1168	200	DA1293	116, 156
320647LCS	77	ANR2763MMM	44	DA1062	47	DA1169	200	DA1294	116, 156
320647RPI	77	ANR3285PY	125	DA1062AMBER	47	DA1170	198	DA1300	155
320647T	77	ANR3285PY-YELLOW	125	DA1062BLUE	47	DA1171	99	DA1305	162, 166
320674CB	77	ANR3305PY	125	DA1062COVER	47	DA1171K	10, 99	DA1306	162, 166
320674CG	77	ANR3305PY-YELLOW	125	DA1062FOGA	47	DA1172	152	DA1307	17
320674LCS	77	ANR3332PY	125	DA1062FOGW	47	DA1173	182	DA1307T	17
320674RPI	77	ANR3332PY-YELLOW	125	DA1063	47	DA1174	93	DA1308	17
320674T	77	ANR3410PY	125	DA1064	47	DA1174GM	93	DA1308T	17
320737CB	77	ANR3410PY-YELLOW	125	DA1065	183	DA1174HM	93	DA1309	162, 166
320737CG	77	ANR3631MNH	42	DA1070	162, 165 - 166	DA1174SM	93	DA1311	17
320737LCS	77	ANR3635	54	DA1070SS	162, 166	DA1176	182	DA1311T	17
320737RPI	77	ANR3973	41	DA1071	186	DA1178	84	DA1312	17
320737T	77	ANR4188EYELLOW	124	DA1072	186, 188	DA1179	195	DA1312T	17
331110AG	75	ANR4188PY	124	DA1073	186	DA1182	155	DA1313	17
331110SA	75	ANR4188PYE	124	DA1077	47	DA1183	155	DA1313T	17
331113AG	75	ANR4188PY-YELLOW	124	DA1077G	47	DA1185	155	DA1357	194
331113SA	75	ANR4189EYELLOW	124	DA1079	11	DA1186	122, 161	DA1360	40
331259AG	75	ANR4189PY	124	DA1080	47	DA1187	15, 161, 195	DA1400	196
331259SA	75	ANR4189PYE	124	DA1080G	47	DA1188	15, 161, 195	DA1401	196
331260AG	75	ANR4189PY-YELLOW	124	DA1081	63	DA1189	182	DA1402	196
331260SA	75	ANR4489	87	DA1082	63	DA1191	47	DA1403	196
331371AG	75	ANR4583PM	41	DA1087	108	DA1192	47	DA1404	196
345985P	11	ANR4583SILVER	41	DA1087FL	109	DA1193	14	DA1405	196
509045PX	173	ANR4635PM	41	DA1088	108	DA1194	14	DA1406	196
548205PY	125	ANR4636PM	41	DA1089	28, 29	DA1195	92, 153	DA1810	73
548205PY-YELLOW	125	ANR5307MNH	42	DA1090	29	DA1196	92, 153	DA1888	126, 148
552818PY	125	ANR5593PM	41	DA1091	29	DA1197	14	DA1960	18
552818PY-YELLOW	125	ANR6091	40	DA1092	29	DA1198	14	DA1961	18
552819PY	125	ANR6094L	40	DA1093	29	DA1199	124	DA1962	122
552819PY-YELLOW	125	ANR6947PY	125	DA1108	108	DA1200DEF	155	DA1963	194
563165/6/7/8	154	ANR6947PY-YELLOW	125	DA1108TDI	109	DA1200DEFG	155	DA2001N	165
568858PY	125	ASB710260	162	DA1109	108	DA1200DIS	155	DA2001O	165
568858PY-YELLOW	125	ASB710270	162	DA1109DEF	109	DA1200DISG	155	DA2002	165
569746PY	125	ASR1186	163	DA1109DIS	109	DA1203	80, 198	DA2003	130
569746PY-YELLOW	125	ASR1187	163	DA1110	120	DA1204	80, 198	DA2004	8
572068PY	125	ASR1594	163	DA1111	182	DA1205	198	DA2005	154

Table with 4 columns: Part Number, Page Number, Part Number, Page Number. Contains parts DA8045 to DA8951.

Table with 4 columns: Part Number, Page Number, Part Number, Page Number. Contains parts EAH500290LUP to EAH500100PMA.

Table with 4 columns: Part Number, Page Number, Part Number, Page Number. Contains parts KVL100040 to LRO15089.

Table with 4 columns: Part Number, Page Number, Part Number, Page Number. Contains parts LRO15303 to LRO32903G.

Table with 4 columns: Part Number, Page Number, Part Number, Page Number. Contains parts LR032954 to LR039935G.

Table with 4 columns: Part Number, Page Number, Part Number, Page Number. Contains parts LRK10087ENG to LR039935G.

Table with 4 columns: Part Number, Page Number, Part Number, Page Number. Contains parts MXC8335 to RBX500291PF.

Part Number	Page Number	Part Number	Page Number	Part Number	Page Number	Part Number	Page Number	Part Number	Page Number	Part Number	Page Number
RTC8969	11	STC3416	40	STC543	162	VPLAS0130PVJ	70	VPLVT0065	59	A Bars	9
RTC9479	15	STC3417	40	STC60713	194	VPLAS0197	67	VPLVT0069	59	Adjustable ball joint	122
RTC9503AA	12	STC3418	40	STC618PY	125	VPLAS0198	67	VPLVT0078	59	Air compressor replacement fuses	82
RTC9505AC	24	STC3419	40	STC618PYYELLOW	125	VPLAT0011	57	VPLW0165	15	Air compressors	38, 82
RTC9535	40	STC3420	40	STC7555	62	VPLCP0203	15	VPLW0166LR	15	Air compressors & tyre repair kit	29 - 30
RTC9562	15	STC3421	40	STC7582	30	VPLCP0204	15	VPLW0167	15	Air conditioning kits	196
RTC9593AA	24	STC3422	40	STC7623LR	40	VPLCP0205LR	15	VPLW0191	25, 187	Air filters	110 - 111
RTC9840CC	202	STC3423	40	STC7631	23	VPLCP0209LR	24	VPLW0192	25, 187	Air intakes	186, 188 - 189, 194
RTC9841CE	202	STC3424	40	STC7631MT	23	VPLCP0210LR	24	VPLWS0228PVJ	70	Air lift kits	130
RTC9842CE	202	STC3425	40	STC7632	23	VPLCS0268LR	64	VPLWS0228SVA	70	Air spring conversion kits	133
RTC9846CH	202	STC3426	40	STC7632MT	23	VPLCS0269	66	VPLWS0229PVJ	70	Air springs	130
RTC9863CE	202	STC3427	40	STC7639	29	VPLCS0271	66	VPLWS0229SVA	70	Air suspension compressor	126, 148
RTC9947CF	202	STC3428	40	STC7643	46	VPLCS0273LR	64	VPLWS0230PVJ	70	Air suspension compressor bracket	126, 148
RTC9970CE	202	STC3429	40	STC7644	46	VPLCS0274LR	64	VPLWS0230SVA	70	Alloy bleed screw	155, 198
SDB000201G	152	STC3435	173	STC7703	30	VPLCS0278LR	67	VPLWT0114	60	Alloy wheels	42 - 44
SDB000211G	152	STC3435S	173	STC793/4/5/6	154	VPLCS0279LR	64	VPLWT0159	59	Alternator upgrade kits	92, 153
SDB000330G	152	STC3580	40	STC7939AB	62	VPLCS0280LR	67	VTD500010	24, 190	Aluminium header tanks	112
SDB000380G	152	STC3581	40	STC7978AB	15	VPLCS0281LR	6	VTD500020	24, 191	Anti-freeze	174
SDB000470G	152	STC3582	40	STC8027LR	13	VPLCS0291PVJLR	70	VTK500010	24, 190	Anti-rattle jack clamps	87
SDB000604G	152	STC3583	40	STC8056	11	VPLCS0291SVALR	70	VTK500020	25, 189	Anti-roll bar kits	120
SDB000614G	152	STC3584	40	STC8057AC	30	VPLCS0292PVJLR	70	VUB000700	66	Anti-squeal shims	104, 150
SDB000624G	152	STC3585	40	STC8130AB	24 - 25	VPLCS0292SVALR	70	VUB000720	59	ARB diff lockers	82 - 83
SDB000636G	152	STC3586	40	STC8138AB	85	VPLCS0293PVJLR	70	VUB000730	59	Armrests	72 - 73
SDB000646G	152	STC3587	40	STC8156AA	120	VPLCS0293SVALR	70	VUB000740	59	Ashcroft Transmission diff locker	83
SDB100830G	152	STC3588	40	STC8156AAPY	120	VPLCT0140LR	56	VUB001070LR	13, 186	Autojaw coupling	54
SDB101070G	152	STC3589	40	STC8295	165	VPLCT0142LR	56	VUB001080LR	13, 186	Automatic transmission flush & fill	184
SDB500182G	152	STC3601	40	STC8354	162	VPLCT0147	56	VUB001230	25, 187	Automatic transmission service kits	157, 172
SDB500193G	152	STC3758G	156	STC8355	162	VPLCT0148LR	56	VUB001300	25, 187	Axle parts	158, 198
SDB500202G	152	STC4235VT	174	STC8356	162	VPLCT0182LR	57	VUB001310	25, 187	Ball joint repair kits	149
SE105161L	48	STC4286	55, 57	STC8358	159	VPLCT0185LR	57	VUB001330	15	Batteries	92
SERVICE KIT LEAFLET	211	STC4404	173	STC8363	159	VPLDP0067	22	VUB002120	63	Battery charger	92
SERVICE STICKER	172	STC4596VT	174	STC8414	62	VPLDP0068	22	VUB002510	25, 187	Battery management system	93
SFC500080	151	STC4600	173	STC8453G	12	VPLDR0063	30	VUB500510	62	Bearing grease	173
SFC500080G	151	STC4637	48	STC8480LR	46	VPLDR0064	30	VUB500520	12	Bike racks	129
SFP000250	151	STC4672	174	STC8503AALR	13	VPLDS0011	70	VUB500900	204	Bilstein shock absorbers	129
SFP000250G	151	STC4676	174	STC8504ABLR	13	VPLDS0147	67	VUB501170	62	Blanking kits	108 - 109
SFP000260	151	STC4687	174	STC8505AAA	25	VPLDT0086	55	VUB501200	12, 191	Blanking plug	198
SFP000260G	151	STC4757	92	STC8524	63	VPLDV0001	194	VUB501380	12, 191	Bleed screw, alloy	155, 198
SFP000270	151	STC4861	174	STC8529AA	85	VPLDV0003	194	VUB501390	13	Blind spot mirrors	14
SFP000270G	151	STC4862	176	STC8535	15	VPLDW0095PVT	41	VUB501920	13, 189	Blindo wheels	43
SFP000280	151	STC4862G	174	STC8536	15	VPLFR0091	29	VUB501930	13, 189	Body repair consumables	179
SFP000280G	151	STC4863	176	STC8537	92	VPLFS0107PVJ	70	VUB501980	9, 189	Bodywork	163 - 164
SFP100360	151	STC4863G	174	STC8604	162	VPLFS0233	67	VUB502130	30	Bolt kits	148
SFP100360G	151	STC50026	12	STC8605	162	VPLFS0234	67	VUB503650	186	Bolts	173
SFP500010	151	STC50027	12	STC8606	162	VPLFS0244	63	VUB503660	25, 186	Bonnet	194
SFP500010DT	107	STC50032	24	STC8607	162	VPLFS0245PVJ	67	VUB503940	15	Bonnet grilles	192
SFP500010G	151	STC50050	64	STC8608	162	VPLFS0246PVJ	67	VUB503960	59	Bonnet hinge kits	195
SFP500070	151	STC50052AA	64	STC8609	162	VPLFT0001	58	VUB504110	11	Books, manuals & technical publications	202
SFP500070G	151	STC50053AA	64	STC8610	162	VPLFT0077	58	VUH000020	174	Boost box	115
SFP500120	151	STC50063	28	STC8648	162	VPLFT0105	58	VYK000010	48	Boot protection	63 - 65
SFP500120G	151	STC50064	12	STC8649	162	VPLFT0106	58	XBD100670LED	48	Bottle jack	87
SFP500130	151	STC50080	40	STC8652	162	VPLFT0118	58	XBD500010LED	48	Boxes, roof	30
SFP500130G	151	STC50081	57	STC8653	162	VPLFT0119	58	XBD500050LED	48	Brake anti-squeal pads	104
SFP500150	151	STC50082AA	62	STC8693	162	VPLFT0120	58	XDISC	108	Brake caliper pistons	152
SFP500150G	151	STC50134	28	STC8694	162	VPLG0100	25, 187	XFC100550CH	194	Brake cleaner	173, 176
SFP500160	151	STC50172	67	STC8695	162	VPLG0109	15	XFC100550LED	48	Brake discs	104 - 105, 152
SFP500160G	151	STC50181	57	STC8843AAA	40	VPLG0110	15	XFD100100LED	48	Brake fitting kit	150
SFP500180	151	STC50243	50	STC8875	57	VPLG0111	15	XFD500010	48	Brake hose kits	107
SFP500180G	151	STC50269AA	23, 55	STC8919AA	57, 60	VPLG0226	25, 187	XFD500010LED	48	Brake kits	150
SFP500190	151	STC50287AB	56	STC8972	173	VPLGS0153	66, 187	XFD500010LED	48	Brake lubrication	104 - 150
SFP500190G	151	STC50289AB	56	STC9021CC	202	VPLGS0154PVJ	70	XFD500040LED	48	Brake pads	106 - 107, 151 - 152
SFP500200	151	STC9049CA	24	STC9049CA	202	VPLGS0154SVA	70	XFD500050LED	48	Brake pipe tool	150
SFP500200G	151	STC50301	23, 55	STC9124	153	VPLGS0155PVJ	70	XFD500050LED	48	Brake pipes	150
SFP500210	151	STC50319	56	STC9155	174	VPLGS0155SVA	70	XFE500010	48	Bridging ladders	87
SFP500210G	151	STC50323	62	STC9157	174	VPLGS0263	65	XFE500010LED	48	Britpart Expedition roof racks	31
SFS500012KIT	150	STC50383	49	STC9157LR	174	VPLGT0073	60	XFE500010LEDCL	48	Britpart Lynx Eye	49
SIJ500030	174	STC50389	57	STC9158	174	VPLGT0082	59	XGB100310L	194	Britpart merchandise & clothing	206 - 207
SIJ500040	174	STC50391	58	STC9158LR	174	VPLHT0061	60	XPAD	108	Bulkhead	127
STC1066	163	STC50408	49	STC9189	151	VPLHT0062	60	XQB500080	46	Bulkhead fitting kit	82
STC1135	164	STC50413	9	STC9189G	151	VPLMS0085PVJ	70	YGD000271	92	Bulkhead parts	162 - 163
STC1136	164	STC50417	28	STC9190	151	VPLMS0085SVA	70	YGD100860	92	Bump stops	124
STC1172B	154	STC50433	30	STC9190G	151	VPLMS0087PVJ	70	YGD500100	92	Bumper bolt kits	10, 99
STC1184K	153	STC50434	63	TAG000230CWP	158	VPLMS0087SVA	70	YGD500130	92	Bumper caps	194
STC1188	48	STC50435	63	TRC102900	158	VPLPP0060	9	YMZ101030	58	Bumperettes	10, 16
STC1424	162	STC50459	58	TRC103150	158	VPLPP0061	9	YWC000840	60	Bumpers	10, 16
STC1601	151	STC50460	58	TRC103160E	158	VPLSP0010	13, 189	YWJ101500	55	Bumpers, winch	98 - 99
STC1601G	151	STC50479	62	TRC103350E	158	VPLSP0016	15	YWJ500070	58	Bungee/clic load securing system	35
STC1694/5/6/7	154	STC50519	177	TYK500010	176	VPLSS0016	65	YWJ500201	57	Bush fitting tool	124
STC1774VT	174	STC50519-20L	177	TYK500010-20L	176	VPLSS0026PVJ	70	YWJ500450	60	Bush set - Watts linkage	124
STC2015	152	STC50519LR	174	TYK500010G	174	VPLSS0042	189	YWJ500460	60	Bush sets	124 - 126
STC250	157	STC50529	174	TYK500030	176	VPLSS0043	65	YWT10002L	57 - 58, 60	Bushes	120
STC2802B	154	STC50530	174	TYK500050	157, 176	VPLSS0104	67			Calibration blocks	142, 181
STC2813	163	STC50531	176	TYK500050-20L	176	VPLSS0138	66			Calibration tools	142, 181
STC2814	163	STC50531LR	174	TYK500050-4L	176	VPLTP0064	13, 189			Caliper rebuild tool kit	182
STC2815	163	STC50543	174	TYK500050G	157, 174	VPLVP0065	15			Caliper tool	182
STC2816	163	STC50544	174	TYL100030	173	VPLVP0066	15			Cam cover gasket set	154
STC2828VT	174	STC50549	174	UMAGBG	209	VPLVP0069	15			Camera kits	16
STC2862A	174	STC50550	174, 179	URB500060	159	VPLVP0070	15			Camera, dash	9
STC2864VT	174	STC50551	174	URB500060B	159	VPLVP0071	25, 192			Camping chair	205
STC2952	151	STC50552	179	UTP1725	157	VPLVP0184	25			Canvass hoods	75
STC2952G	151	STC53075AA	15	VPLAB0025LML	188, 190	VPLVS0070PVJ	70			Carburetors, Weber	115
STC3018SS	50	STC53076AA	15	VPLAP0008	12, 191	VPLVS0071PVJ	70			Cargo tie down point	198
STC3135	157	STC53077	23	VPLAP0009	12, 191	VPLVS0072PVJ	70			Carpet mats	85
STC3261	157	STC53157	11	VPLAP0013	18	VPLVS0073PVJ	70			Carriers, roof	60
STC3410	40	STC53158	11	VPLAP0017	15	VPLVS0077PVJ	70			Carry straps	35
STC3411	40	STC53161	11	VPLAP0022	9, 190	VPLVS0077PVJ	70			Castor corrected bushes	124
STC3412	40	STC53181	12	VPLAP0035	24, 190	VPLVS0089	65			Castor corrected swivel housings	120
STC3413	40	STC53193	12	VPLAR0001	30	VPLVS0090	65			Castor correction wedges	131
STC3414	40	STC53194	12	VPLAS0015	64	VPLVS0091	65			Castrol oil merchandise	175
STC3415	40	STC542	162	VPLAS0023PVJ	67	VPLVS0102	66			Castrol oils	175



Heater plug upgrade kit	155	Lights, driving	46	Piston	156
Heavy-duty drive flanges	120	Lights, fog	46	Piston ring set	156
Heavy-duty shock absorbers	127	Lights, LED	48	Plate, sump	19
Heavy-duty steering arms	135	Lights, NAS	47 - 48	Plate, transmission	19
Hi-Lift jacks	86 - 87	Lights, Roo-lites	47	Polybush bushes	124
Hood stick kits	75	Liner set	155	Portable Powerpacks	88
Hoods	75	Loadspace nets & retention kits	66	Powerflex bushes	126
Hylomar compounds	173	Loadspace protectors	63 - 65	PowerPacks	88
Hylomar sealants	173	Loadspace protectors - premium	65	Premium loadspace protectors	65
Hylossil instant gasket	173	Loadspace retention kits	66	Pressure relief valve	155
Ignition lead sets	153	Locking fuel cap	10	Propshaft bearings	158
Ignition module & link lead	153	Locking pegs	197	Propshaft kit	135
Indicator bulbs	188, 190, 193	Locking wheel caps	40	Propshaft spacer kit	135
Inflator	39	Locking wheel keys	40	Propshafts, wide angle	135
Injector pipe sets	154	Locking wheel nuts	40	PSI power tuning	114
Injector washer kits	155	Loctite consumables	179	Pulleys & shackles	100
Inner tubes	38	Long range fuel tanks	85	Radiator mufflers	204
Inspection lamp	184	Lowered springs	131	Radius arms	121
Inspection lamps	51	Lynx diagnostics interface	139	Raised air intakes	88 - 89
Instant gasket	173	Lynx Eye	49	Range Rover book	203
Intercooler silicone hoses	112	Magbooks	203	Raptor	178
Intercoolers	111	Main bearing sets	154	Ratchet straps	66
Interior roof console	198	Manifold inlet seal	155	Ravenol anti-freeze/coolant	177
Intermediate reduction drive repair kit	158	Marsland chassis	161	Ravenol Classic oils	179
IRD crown wheel & pinion	158	Mats	6, 67 - 68	Ravenol oils	176 - 177
IRD repair kit	158	MaxXtrac wheels	43	Rear 1/4 chassis	163
Isolator switch	101	Merchandise	207	Rear diffs & carriers	160
Jack base	87	Mirrors	14	Rear end door hinge kit	162
Jack clamps	87	Model engine	210	Rear seats	77
Jackall jacks	86	Models	208 - 209	Rear silencer	117
Jacking equipment	86 - 87	Mont Blanc racks	30	Rear spoiler	193
Jerry cans	85	Mudflap brackets	15, 195	Rear spring sets	122
Jubilee clips	173	Mudflaps	15	Rear steps	23
K&N air filters	111	NAS lights	48	Reconditioned engines	155
Ladders	28	New engines	155	Recovery kits	85
Ladders - sand & bridging	87	Nose panel	165	Recovery ladders	87
Land meters	87	Number plate light	194	Remote reservoir shock absorbers	127
Land Rover genuine consumables	174	Number plate mounting bracket	99, 195	Replacement batteries	92
Land Rover Merchandise	208 - 209	Nut & retainer	173	Replacement fuses	82
Land Rover models	210	Nuts	173	Replacement surround cameras	16
Land Rover Original technical publications	203	Nuts & bolts	10, 98	Re-trim kits	78
Landy books	203	Oil cooler repair kit	155	Retrofit insert seat heater	77
Leaf spring castor correction wedges	131	Oil filter	155	Reversing camera kit	16
Leaf springs	130	Oil pump gear set	155	Revotec electric fans	113
LED bumper	10, 47	Oil test kit	177	Richards chassis	161
LED daytime lights	46 - 47	Oils	174 - 175	Rock sliders	17
LED headlamps	49	Old Man Emu shock absorbers	129	Rockers	156
LED light bars	50	Old Man Emu springs	131	Roll cages	34
LED lights	48	Old Man Emu steering dampers	135	Roof boxes	30
Lift rod kit	87 - 123	Optima batteries	92	Roof carriers	29 - 30
Lifted springs	132	Original technical publications	203	Roof console	198
Light bars	50	Paints	174	Roof ladders	28
Light bars, LED	50	Panhard rods	120	Roof racks	29 - 33
Light bulb kits	49	Parabolic springs	130	Roof racks & bars	29 - 30
Light conversion kits	48	Parking brake spring kits	150	Roof racks, galvanised	29
Light guards	Nov-13	Parking sensors	16	Roo-lites	47
Light guards	13	Parts catalogues	202	Ropes & straps	100
Light kits	47	Peak Performance air filters	110	Rubber mats	6, 67 - 68
Light mounting kits	50	Pedal sets	189, 191	Rubbing strips	18
Light upgrade kits	49	Performance air filters	110	Safari raised air intakes	89
Light upgrades	48 - 49	Performance brake discs	104	Safety Devices roof racks	32 - 33
Lights, Cibie	46	Performance intercoolers	111	Safety equipment	101

Sand ladders	87	Steps, rear	23	USB charger	196
Santana clutch kit	159	Steps, side	22 - 25	Utility link pipes	117
Screws	173	Strops & ropes	100	Valve Caps	38
Scuff plate	192	Stub axle kits	148	Vehicle enhancements	186 - 198
Seat belt stress plate	74	Sump guards	19	Vent hinge pin kit	195
Seat belts	74	Sump plate	19	Vent knobs	197
Seat box panel	162, 165	Super Crystal headlights	48	Voltmeter gauge	196
Seat covers	69 - 70	Super Gaz shock absorbers	128	Water pumps	156
Seat handle & cover kit	80	Super Gaz steering dampers	135	Water sensor repair kit	156
Seat heater	77	Suspension arm & bolt kits	121	Waterproof seat covers	69 - 70
Seat rails	73	Suspension arms	121	Watts linkage bush set	124
Seats	76 - 79	Suspension ball joint repair kits	149	Weber carburetors	115
Security marking kit	204	Suspension bolt kits	121, 148	Wheel adaptor kits	40
Sensors, parking	16	Suspension calibration	142, 181	Wheel arch kits	18
Service kits - Alternative Brand	169 - 172	Suspension kits	136	Wheel bearing kits	149
Service kits - Britpart	169 - 172	Suspension mounts	162 - 165	Wheel carriers	38
Service kits - Genuine	169 - 172	Swivel housing gaiter kits	20	Wheel chocks	101
Service kits - XD Brand	169 - 170	Swivel housing grease	173	Wheel hub & bearing	149
Service stickers	172	Swivel housing kit	120	Wheel spacers	40
Shackles & pulleys	100	Swivel housing kits	148	Wheel strap	38
Shock absorber brackets	122	Swivel pin kits	148	Wheel wrenches	40
Shock absorber turrets	122	Tailgate chain cover	80	Wheels, alloy	42 - 44
Shock absorbers	127 - 129	Tailgate conversion trim kit	189	Wheels, steel	41
Short filter	155	Tamper proof bolts	10, 98	Wide angle propshafts	135
Side steps	17, 22 - 25	Tamper proof nuts	10, 98	Winch bumper fitting kit	99
Side vent trim	190	Techno style seats	76	Winch bumper kits	98
Silencers	117	Thread locker	179	Winch bumpers	99
Silicone coolant hoses	112	Thule racks	29	Winch fairleads	100
Silicone hose kits	109	Timing kits	155	Winch remote control	101
Silicone sleeves	19	Timing tools	181	Winch safety equipment	101
Silicone spray	177	Tools	181 - 184	Winch spare parts	97
Silicone turbo hoses	112	Top hat liner set	155	Winches	95 - 97
Sill tread plate kit	186, 189, 191, 193	Torches	184	Winching accessories	99, 101
Sills	163 - 165	Touch up paint pens	175	Winching kits	100
Snow cowls	194	Tow bars	54 - 60	Wind deflectors	20
Sound deadening	199	Towing equipment	54 - 60	Window bodywork	162, 165
Sparco seats	79	Trade tack stab	78, 173	Window kits	167
Spare light bulb kits	49	Transfer box	160	Windscreen brackets	195
Spare wheel carriers	38	Transmission plate	19	Wing mirror cover	186, 188, 190, 193
Spare wheel covers	157	Transmission service kits	157	Wing mirror, heated	196
Spare wheel protectors	40	Travel kits	84	Wing mirrors	14
Spare wheel strap	38	Tree sliders	17	Wings	162 - 165
Split charge relay	93	Trim, dash	80	Wipac light conversion kit	48
Spring kits, parking brake	150	Trim, door	80	Wiper blades	204
Spring retainers	122	T-Shirts	206	Wiper relay - programmable	153
Spring spacer blocks	123	Tuning box	114	Work light	51
Springs, air	130	Tuning products	114 - 115	Workshop fluids	174
Springs, coil	131 - 132	Tunit	114	Workshop manual	202
Springs, leaf	130	Turbo boost box	115	Workshop tools	181 - 184
Springs, parabolic	130	Turret rings	122	XD Brake Pads	151
Stainless steel bolts	200	Turrets	122	XD handling kit	131
Stainless steel brake caliper pistons	152	Twin tail pipe	116 - 117	Xenon headlight bulbs	49
Stainless steel exhausts	115 - 117	Tyre deflator	39	Xenon headlight upgrade	49
Stainless steel screws	200	Tyre inflation kit	39, 82	XS Brake Discs	152
Starting handle	40, 204	Tyre inflator	39	XS Brake Pads	151
Steel wheels	41	Tyre pressure monitoring system	39	XS style seats	78
Steering arm fixing kit	135	Tyre repair kit	38 - 39, 82	XS Water pumps	156
Steering arms, heavy-duty	82	Tyre repair kit	82	X-Trouser	198
Steering box repair kit	148	Ultimax brake pads	106	Yellow Stuff brake pads	106
Steering dampers	135	Umbrella holder	66, 187	Zu wheels	44
Steering rack ball joint repair kits	148	Universal joint silicone sleeves	19		
Steering wheels	199	Upgrade chip	114		





BRITPART

The quality parts for Land Rovers

www.britpart.com

A world of Land Rover parts and accessories
all under one (well several) roofs!

United Kingdom Registration Years

Suffix letter series 1963 - 1983

Letter	From	To
A	1st January 1963	31st December 1963
B	1st January 1964	31st December 1964
C	1st January 1965	31st December 1965
D	1st January 1966	31st December 1966
E	1st January 1967	31st July 1967
F	1st August 1967	31st July 1968
G	1st August 1968	31st July 1969
H	1st August 1969	31st July 1970
J	1st August 1970	31st July 1971
K	1st August 1971	31st July 1972
L	1st August 1972	31st July 1973
M	1st August 1973	31st July 1974
N	1st August 1974	31st July 1975
P	1st August 1975	31st July 1976
R	1st August 1976	31st July 1977
S	1st August 1977	31st July 1978
T	1st August 1978	31st July 1979
V	1st August 1979	31st July 1980
W	1st August 1980	31st July 1981
X	1st August 1981	31st July 1982
Y	1st August 1982	31st July 1983

Prefix letter series 1983 - 2001

Letter	From	To
A	1st August 1983	31st July 1984
B	1st August 1984	31st July 1985
C	1st August 1985	31st July 1986
D	1st August 1986	31st July 1987
E	1st August 1987	31st July 1988
F	1st August 1988	31st July 1989
G	1st August 1989	31st July 1990
H	1st August 1990	31st July 1991
J	1st August 1991	31st July 1992
K	1st August 1992	31st July 1993
L	1st August 1993	31st July 1994
M	1st August 1994	31st July 1995
N	1st August 1995	31st July 1996
P	1st August 1996	31st July 1997
R	1st August 1997	31st July 1998
S	1st August 1998	28th February 1999
T	1st March 1999	31st August 1999
V	1st September 1999	29th February 2000
W	1st March 2000	31st August 2000
X	1st September 2000	28th February 2001
Y	1st March 2001	31st August 2001

New style series 2001 - onwards

Year	1st March to 31st August	1st September to 28th February
2001/2002	N/A	51
2002/2003	02	52
2003/2004	03	53
2004/2005	04	54
2005/2006	05	55
2006/2007	06	56
2007/2008	07	57
2008/2009	08	58
2009/2010	09	59
2010/2011	10	60
2011/2012	11	61
2012/2013	12	62
2013/2014	13	63
2014/2015	14	64
2015/2016	15	65
2016/2017	16	66
2017/2018	17	67

Get All The Latest Britpart News

We have two easy ways to keep in touch with all the latest news and product releases.

1. Newsletter

Simply log on to www.britpart.com and register your details in the 'Mailing List' section or simply send an e-mail with newsletter in the subject field to - marketing@britpart.co.uk

2. Facebook

Go to www.facebook.com/britpart and click the 'like' button to see all the latest product releases when they happen - no need to wait for the next catalogue release.

Make Your Land Rover A Star

If you have a great picture of your Land Rover and would like to see it featured in the next Britpart catalogue, then please send it to marketing@britpart.co.uk with all your details. We look forward to seeing them and each one sent in will automatically be entered into the next Britpart calendar competition. See www.britpart.com/calendar for more details on the competition. Happy snapping!

The Small Print

- > Britpart is a wholesaler only. To purchase parts and for technical questions, contact your local stockist. To find yours go to www.britpart.com/distributors
- > Part numbers used for identification purposes only and do not imply or indicate the identity of a manufacturer.
- > Genuine Land Rover parts and accessories are for sale in EU countries only.
- > Parts are subject to stock and supply.
- > Pictures are for reference only and specifications may alter without notice.
- > Colour swatches are for reference only - samples are available on request.
- > All products available at time of printing and we reserve the right to withdraw any product at any time.
- > Land Rover logos and trade names are for reference only.
- > No part of this catalogue may be used or reproduced by any means without the express permission of Britpart.
- > Product specifications are given but it is up to the end user to ensure that the product is fit for that purpose.
- > E&OE



BRITPART

The quality parts for Land Rovers



VORTEX Handels GmbH

Bundesstraße 27

A-7093 Jois

02160 / 76 006

vortex@teile.at

www.teile.at

